

OKONITE CABLES

STOCK CATALOG

“▲” *In Stock for Immediate Delivery*

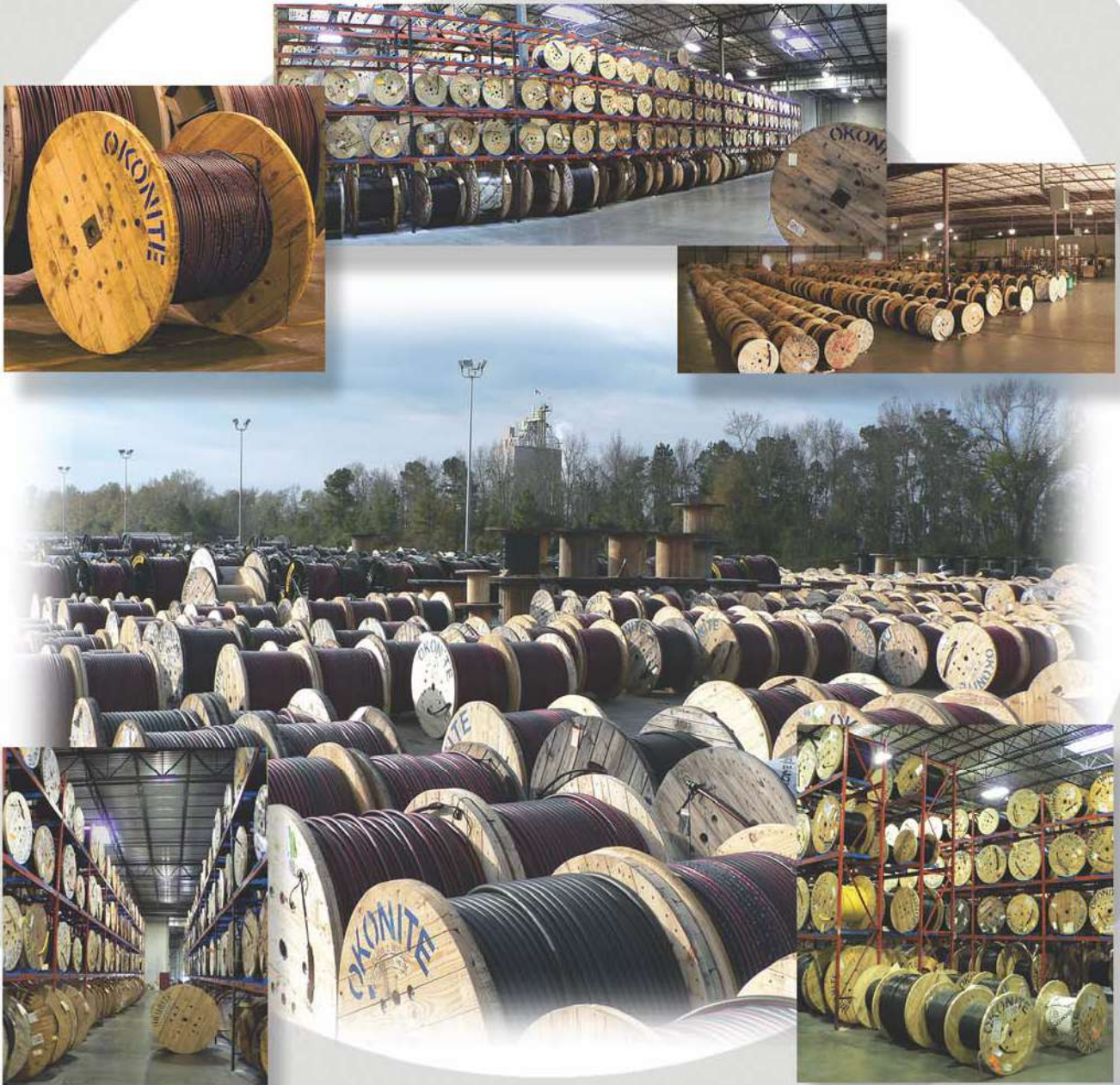

**THE
OKONITE
COMPANY**



THE OKONITE COMPANY

Welcome to Okonite's OSC -Stock Catalog.

This catalog is a condensed version of Okonite's full product line catalog and only contains those products available through our stock program. Specific stock catalog items are noted beside the catalog number with this symbol ▲.

Okonite manufactures a full line of cables from 300V to 345kV. A full product line catalog can be provided by your local Okonite representative. All Okonite product catalog information is also available online via our website www.okonite.com. This is always the most up-to-date information and a great way to find out more about Okonite.

Actual on-hand quantities of stock items as well as any Okonite information can be obtained by contacting your local Okonite Sales Office. Contact information is located on the back cover of this catalog.

Thank you for your interest in Okonite Cables.

INDEX

Data Sheet
Section:Sheet

GLOSSARY OF TERMS AND DEFINITIONS

MEDIUM VOLTAGE POWER CABLES 2.4kV AND ABOVE

Single Conductor Cable

Okoguard Non-Shielded Okolon TS-CPE Type MV-90 (CT USE) 2.4kV	2:2
Okoguard Shielded Okoseal Type MV-105 (CT USE) 5/8kV	2:3
Okoguard Shielded Okoseal Type MV-105 5/8 kV	2:4
Okoguard Shielded Okoseal Type MV-105 (CT USE) 15kV	2:8
Aluminum Okoguard Shielded Okoseal Type MV-105 (CT USE) 15Kv	2:59
Okoguard Shielded Okolon TS-CPE Type MV-105 (CT USE) 15kV	2:11
Okoguard Shielded Okoseal Type MV-105 (CT USE) 35kV	2:57
Okoguard Shielded Okoseal 69kV	2:18

Multi-Conductor Cable

Okoguard Shielded Okoseal Type MV-105 (CT USE) 3/C 5/8kV	2:19
Okoguard Shielded Okoseal Type MV-105 (CT USE) 3/C 15kV	2:20
Okoguard Non-Shielded C-L-X Type MV-90 or MC-HL (CT USE) 2.4kV	2:21
Okoguard Shielded C-L-X Type MV-105 or MC-HL (CT USE) 5/8kV	2:22
Okoguard Shielded C-L-X Type MV-105 or MC-HL (CT USE) 15kV	2:24
Solid Type PILC 3/C 15kV	2:31

UNDERGROUND RESIDENTIAL DISTRIBUTION CABLE

Okoguard URO-J 15kV Aluminum Conductor	2:35
Okoguard URO-J 15kV Filled Strand Aluminum Conductor	2:36
Okoguard URO-J 25kV Aluminum Conductor	2:39
Okoguard URO-J 35kV Aluminum Conductor	2:40
Okoguard URO-J 15kV to 35kV Copper Conductor	2:42

LOW VOLTAGE CABLES TO 2kV

Single Conductor Cable

Okoguard Okolon TS-CPE Type RHH or RHW-2 or USE-2, VW-1 600V RW-90	3:1
Okoguard Okolon TS-CPE Type RHH or RHW-2, 2000V	3:10

Multi-Conductor Cable

C-L-X Type MC-HL for CT USE (XHHW-2) 600V	4:1
C-L-X Type MC (XHHW-2) 600V	4:2
Okonite-FMR Okoseal Type TC 600V	4:5
X-Olene - Okoseal Type TC-ER Control Cable (XHHW-2) 600V	4:8
C-L-X Type MC for CT USE (XHHW-2) 600V Control Cable	4:14
C-L-X Type MC-HL for CT USE (XHHW-2) 600V Control Cable	4:15

INDEX

Data Sheet
Section:Sheet

INSTRUMENTATION CABLES

Okoseal Type P-OS 300V	5:2
Okoseal Type P-OS C-L-X 300V	5:3
Type SP-OS Instrumentation Cable	5:13
Okoseal Type SP-OS C-L-X 300V	5:14
Okoseal Type P-OS Thermocouple 300V	5:18
C-L-X Okoseal Type P-OS Thermocouple 300V	5:19
Okoseal-N Type P-OS 600V	5:29
Okoseal-N Type SP-OS 600V	5:31
Okoseal-N Type P-OS C-L-X Type MC-HL 600V	5:40
Okoseal-N Type SP-OS C-L-X Type MC-HL 600V	5:42
Okobus C-L-X.....	5:48
C-L-X X-Olene P-OS, SP-OS	5:49
X-Olene P-OS 600V/1000V CIC-TC.....	5:50
X-Olene SP-OS 600V/1000V CIC-TC	5:51

SPECIAL PURPOSE CABLES

X-Ray Low Noise 65-250kV DC	6:1
X-Ray 65-1000kV DC	6:2
Okoguard Aerial Jumper Cable 15kV	6:4
Okoguard-Okolon TS-CPE 5kV Airport Lighting Cable	6:6

RAILROAD AND TRANSIT SYSTEM CABLES

Armored Signal Cable	7:1
Track Wire	7:6
Tower and Case Wire	7:10
Case Wire	7:11
Nylon Braid Case Wire	7:12
Type DEL.....	7:17

SPLICING AND TERMINATING PRODUCTS

C-L-X Terminating Tool Kit	6:5
Color Code Tables	OSL
Miscellaneous Information	OSL

GLOSSARY

INDUSTRY ASSOCIATIONS

ABS American Bureau of Shipping.

AEIC Association of Edison Illuminating Companies.

ANSI American National Standards Institute.

AREMA American Railway Engineering and Maintenance of Way Association

ASTM American Society for Testing and Materials.

ICEA Insulated Cable Engineers Association (formerly IPCEA).

IEC International Electrotechnical Commission

IEEE Institute of Electrical and Electronics Engineers.

NEC National Electrical Code.

NEMA National Electrical Manufacturers Association.

NFPA National Fire Protection Association.

GOVERNMENT AGENCIES

OSHA Occupational Safety and Health Act administered by U.S. Dept. of Labor which establishes employee safety standards in all industrial and commercial establishments.

RUS Rural Utility Systems of the U.S. Department of Agriculture, formerly REA.

FAA Federal Aviation Administration

EPA Environmental Protection Agency

DOE Department of Energy

FERC Federal Energy Regulatory Commission

OKONITE REGISTERED TRADE NAMES

C-L-X® Continuous-Lightweight-Exterior. Welded and corrugated, impervious metallic sheathed cables.

LOXARMOR® An interlocked "S" shaped armor cable covering, normally galvanized steel or aluminum.

OKOBON® A moisture resistant cable finish consisting of an aluminum/copolymer tape fused to itself and to an overall jacket.

OKOBUS® Fieldbus instrumentation cable.

OKOCLEAR TP® (TPPO) Thermoplastic Polyolefin low smoke/zero halogen jacket compound.

OKOCLEAR TS® Thermosetting Polyolefin low smoke/zero halogen jacket compound.

OKOGUARD® Okonite's exclusive ethylene-propylene rubber (EPR) based, thermosetting insulation, with an optimum balance of electrical and physical properties unequalled in other solid dielectrics, used on power cables rated 600 V and above. (50th Anniversary - 2017)

OKOLENE® Thermoplastic polyethylene or polypropylene based insulation or jacket compound.

OKONITE® Okonite's exclusive ethylene propylene rubber (EPR) based, thermosetting insulation used up to 2000V.

OKONITE-FMR® Okonite's exclusive flame and moisture resistant ethylene propylene rubber (EPR) insulation used up to 2000V.

OKOGUARD-OKOLON® Composite insulation system consisting of a layer of EPR and covered with a chlorinated thermoset compound.

OKOPACT® Okonite's unique compact round conductor shape and design.

OKOSEAL® A PVC insulation or jacketing compound with excellent resistance to flame and most chemicals.

OKOSEAL-N® PVC insulated and nylon jacketed low voltage conductors, Type THHN, THWN-2 and TFN.

OKOLON TP-CPE® Thermoplastic moisture resistant CPE compound serving as an outer jacket.

OKOLON TS-CPE® Thermoset moisture resistant flame retardant CPE outer jacket.

OKOTEMP® - Thermoplastic rubber jacketing compound with excellent abrasion resistance combined with flexibility.

OKOTHERM® Heat resistant silicone rubber based insulation for use in high temperature locations.

OKOZEL® Okonite's name for its ETFE based flame and radiation resistant insulating and jacketing compound.

P-30® Okolene-Okoseal insulated 600V multiple and single conductor control cable.

P-45® Okolene-Okoseal Insulated 1000V Multiple Conductor Control Cable.

URO-J Underground Residential distribution-Okoguard (EPR) insulation-Okolene Jacket employing a concentric neutral.

USE Underground Service Entrance Cable. (NEC Article 338)

X-OLENE® Okonite's name for its XLPE insulation and jacket.

STANDARD TERMS

AWG American Wire Gauge, based on the circular mil system where 1 mil equals 0.001 inch.

CIC Cable in Conduit for buried distribution systems.

CIC Circuit Integrity flame retardant cables

C-L-X-M C-L-X Marine Shipboard Cable

CPE Chlorinated Polyethylene jacketing material.

CSA Canadian Standards Association. An independent organization which implements and monitors the commercial and consumer electrical product standards. The CSA assures compliance to the various Canadian Electrical Code requirements.

CT Designation given to cables meeting UL requirements for cable tray use.

CTC Designation for Centralized Traffic Control Code Line cable.

CWCMC UL's designation for 600 volt C-L-X marine shipboard cable - "continuously welded corrugated MC" cable.

DEL Diesel Electric Locomotive and car wiring with Okonite insulation and Okolon jacket.

EPR Ethylene Propylene Rubber insulating compound ingredient.

ER Exposed Run, UL term designating cables approved for open wire applications.

ETFE Modified Ethylene Tetrafluoroethylene compound (Okozel) used for insulation and jackets.

FIELDBUS CABLE - High Speed digital signal transmission instrumentation cable having specific electrical characteristics.

FPL Power limited Fire Protective Signal Cable (NEC Art. 760). 300V rated

FMR Flame and Moisture Retardant.

HL Designation given to MC and ITC cables meeting NEC and UL requirements for use in Division 1 hazardous locations.

INSULATION LEVEL-100% Cable for use on grounded systems or where the system is provided with relay protection such that grounds faults will be cleared as rapidly as possible but in any case within one minute.

INSULATION LEVEL-133% Cable for use on ungrounded or grounded systems or where the faulted section will be de-energized in a time not exceeding one hour.

ITC Instrumentation Tray Cable for

GLOSSARY (continued)

instrumentation & control circuits operating $\leq 150V$ and ≤ 5 amps., per NEC Article 727.

kcmil A unit of conductor area in thousands of circular mils. (Formerly MCM).

LOCA Loss of Coolant Accident, IEEE 383 defines test requirements.

LCS Longitudinal Corrugated Shield.

MC Metal-Clad cable. NEC type designation for power and control cables enclosed in a welded and corrugated metallic sheath (C-L-X), or an interlocking tape armor (Loxarmor). (Article 330)

MC-HL Metal-Clad cable listed for hazardous locations

mil 0.001 inch.

MV Medium Voltage cable. NEC designation for single & multiple conductor insulated cable rated 2001 to 35,000 volts. (NEC Article 328)

NPLF Non-Power Limited Fire Protective Signal Cable (NEC Art. 760). 600V rated

OKO-MARINE UL designation for non-armored Marine Shipboard Cable.

PLTC Type designation for Power-Limited Tray Cable for use in Class 2 or 3 power-limited circuits; instrumentation, supervisory control, and thermocouple extension.

P-NS Single pair or triad, Non Shielded, instrumentation or thermocouple extension cable.

P-OS Single or multi Pairs or Triads with Overall Shield, instrumentation or thermocouple extension cable.

POWER-LIMITED CIRCUIT Circuit either inherently limited requiring no overcurrent protection or limited by a combination of a power source and overcurrent protection.

PVC Polyvinyl Chloride insulating and jacketing material which is usually flame retardant and resistant to many chemicals.

P-104 Okonite's identification number issued by the Pennsylvania Department of Environmental Resources.

RHH NEC conductor type designation for conductors with Heat resistant rubber or XLPE insulation, for use in dry locations.

RHW-2 NEC conductor type designation for conductors with Heat and Moisture resistant rubber or XLPE insulation, for use in 90°C wet or dry locations.

RTA Thermoplastic insulated, aluminum shielded, polyethylene jacketed communication cable.

SCREEN A semiconducting nonmetallic layer used under and over the insulation of power cables rated over 2kV to reduce electrical stresses and corona

SEMICONDUCTING An extruded layer or tape of such resistance that when applied between two elements of a cable the adjacent surfaces of the two elements will maintain substantially the same potential.

SHIELD A nonmagnetic, metallic material applied over an insulated conductor(s) to confine the electric field to the insulation.

SP-OS Multiple Shielded Pairs or Triads with Overall Shield, instrumentation or thermocouple extension cable.

SR Sunlight Resistant

TC NEC type designation for power and control tray cable. (Article 336)

TFN NEC conductor type designation for PVC insulated nylon jacketed conductors in sizes #18 and 16 AWG for use in dry locations.

THERMOCOUPLE CABLE - A cable consisting of two dissimilar metals or alloys that, when electrically joined at one end can be used to measure temperature. These cables have no voltage rating.

THHN NEC conductor type designation for PVC insulated nylon jacketed conductors for use in dry locations.

THWN-2 NEC conductor type designation for PVC insulated nylon jacketed conductors for use in 90°C wet or dry locations.

TPPO Thermoplastic Polyolefin, a thermoplastic jacket material with low smoke characteristics and is free of halogens.

UL Underwriters Laboratories. An independent organization which examines, tests, lists and periodically inspects equipment to appropriate standards.

URD Underground Residential Distribution Cables.

VERTICAL TRAY FLAME TEST

Conducted per UL, IEEE or ICEA procedures to demonstrate that a single conductor (1/0 AWG and larger) or multi-conductor cable will not propagate a fire in the defined test.

VOLTAGE LEVELS

Power-Limited - 0-300 Volts

Low Voltage - 600-2000 Volts

Medium Voltage - 2400-46000 Volts

High Voltage - >46 to 345kV

VOLTAGE RATING V or kV, industry convention to identify voltage levels, phase to phase voltage.

VW-1 Basic flammability test for single conductors; employs a tirrill burner applied intermittently to a Vertical Wire.

XHHW-2 NEC conductor type designation for conductors with Heat and Moisture resistant thermoset insulation for use in 90°C wet or dry locations.

XLPE Cross-Linked Polyethylene insulating compound.

XLPO Cross Linked Polyolefin, a thermoset jacket material with low smoke characteristics and is free of halogens.

Z NEC conductor type designation for conductors with ETFE insulation for use in dry locations.

ZW NEC conductor type designation for conductors with ETFE insulation for use in wet or dry locations.

CONDUCTOR IDENTIFICATION INFORMATION

E-1 Color sequences for utility conductor identification, see Appendix E, Table E-1, ICEA Standard S-73-532, includes green and white.

E-2 Color sequence for industrial conductor identification, see Appendix E, Table E-2, ICEA Standard S-73-532, excludes green and white.

METHOD-1 Conductor identification, colored compounds with tracers in accordance with the ICEA standard.

METHOD-2 Conductor identification, neutral compounds with tracers in accordance with the ICEA Standard.

METHOD-3 Conductor identification, neutral or single colored compounds with surface printing of numbers and color designations in accordance with the ICEA Standard.

METHOD-4 Conductor identification, neutral or single colored compounds with surface printing of numbers in accordance with the ICEA Standard.

METHOD-5 Conductor identification, individual color coding with braids in accordance with the ICEA Standard.



Okoguard®-Okolon® TS-CPE Type MV-90 2.4kV Nonshielded Power Cable

One Okopact® (Compact Stranded)
Copper Conductor/90°C Rating Wet or Dry
For Cable Tray Use-Sunlight Resistant



- A Uncoated, Okopact (Compact Stranded) Copper Conductor
- B Strand Screen-Extruded Semiconducting EPR
- C Insulation-Okoguard EPR
- D Jacket-Okolon TS-CPE

Insulation

Okoguard is Okonite's registered trade name for its exclusive ethylene-propylene rubber (EPR) based, thermosetting compound, whose optimum balance of electrical and physical properties is unequalled in other solid dielectrics. Okoguard insulation, with the distinctive red color and a totally integrated EPR system, provides the optimum balance for long, problem free service.

Jacket

The Okolon TS-CPE jacket on this cable is a vulcanized chlorinated polyethylene based compound which is mechanically rugged, flame, radiation and oil resistant.

Applications

Okoguard-Okolon TS-CPE 2.4 kV cables are heavy duty nonshielded cables designed for use at up to 2.4 kV phase-to-phase in wet or dry locations in accordance with NEC. Okoguard-Okolon TS-CPE nonshielded cables are recommended for power distribution and motor circuits in generating plants and substations; in industrial and commercial buildings.

Single conductors may be installed in industrial or commercial occupancies in triplexed or random lay in any raceway or duct in wet or dry locations, or in open runs as permitted by the NEC.

Sizes 1/0 AWG and larger, may be installed in cable trays where permitted by NEC Section 315.32(3).

Specifications

Conductor: Annealed uncoated copper compact stranded per ASTM B-496.

Strand Screen: Extruded semiconducting EPR strand screen. Meets or exceeds electrical and physical requirements of ICEA S-96-659/NEMA WC71 and UL 1072.

Insulation: Meets or exceeds electrical and physical requirements of ICEA S-96-659/NEMA WC71 and UL 1072.

Jacket: Meets or exceeds electrical and physical requirements of ICEA S-96-659/NEMA WC71 for chlorinated polyethylene jackets.

UL listed as Type MV-90, sunlight resistant, -40°C and for use in cable tray in accordance

with UL 1072. CSA listed as RW90 as 5kV non-shielded (FT4 1/0 and larger) -40°C in accordance with CSA C22.2 No 38.

1/C non-shielded cables can surface discharge in service when in a random phase spacing or when in contact with grounded surfaces.

Product Features

- Okoguard cables meet or exceed all recognized industry standards (UL, CSA, NEMA/ICEA, IEEE).
- 90°C continuous operating temperature.
- 130°C emergency rating.
- 250°C short circuit rating.
- Passes UL and IEEE 383 and 1202/FT4 (1/0 and larger) Vertical Tray Flame Test.
- Sizes 500 kcmil and larger pass ICEA T-29-520 (210,000 BTU/hr) Vertical Tray Flame Test.
- Sizes 1/0 and larger pass CSA FT4 Vertical Tray Flame Test.
- Sizes #1 and smaller pass CSA FT1.
- Excellent corona resistance.
- Radiation resistant.
- Exceptional resistance to "treeing".
- Stress cones not required.
- Moisture resistant.
- Resistant to most oils, acids, and alkalis.
- Sunlight Resistant.
- Sizes #4, #6 and #8 AWG are identified as FAA-L-824, Type B 5kV rated.

Okoguard-Okolon TS-CPE Type MV-90

2.4kV Nonshielded Power Cable

One Okopact (Compact Stranded)

Copper Conductor/90°C Rating Wet or Dry

For Cable Tray Use-Sunlight Resistant



Product Data

Section 2: Sheet 2

Catalog Number (1)	Conductor size AWG or kcmil		Conductor Size - mm ²		Insulation Thickness - mils		Insulation Thickness - mm		Jacket Thickness - mils		Jacket Thickness - mm		Approx. O.D. -Inches		Approx. O.D. -mm		Approx. Net Weight lbs./1000'		Approx. Ship Weight lbs./1000'		Ampacities (2) Conduit in Air		Ampacities (3) Underground Duct		Ampacities (4) Cable Tray		Conduit Size Inches (5)*	
* ▲ 114-24-2213	8	8.4	125	3.18	80	2.03	0.60	15.1	215	250	55	64	-	-	-	-	-	-	-	-	-	-	-	-	-	-	-	2
* ▲ 114-24-2217	6	13.3	125	3.18	80	2.03	0.63	16.0	260	295	75	85	-	-	-	-	-	-	-	-	-	-	-	-	-	-	-	2
* ▲ 114-24-2219	4	21.2	125	3.18	80	2.03	0.67	17.1	328	368	97	110	-	-	-	-	-	-	-	-	-	-	-	-	-	-	-	2
▲ 114-24-2221	2	33.6	125	3.18	80	2.03	0.73	18.6	427	492	130	145	-	-	-	-	-	-	-	-	-	-	-	-	-	-	-	2
114-24-2223	1	42.4	125	3.18	80	2.03	0.76	19.4	493	558	155	170	-	-	-	-	-	-	-	-	-	-	-	-	-	-	-	2½
▲ 114-24-2225	1/0	53.5	125	3.18	80	2.03	0.80	20.3	580	645	180	195	260	-	-	-	-	-	-	-	-	-	-	-	-	-	-	2½
▲ 114-24-2227	2/0	67.4	125	3.18	80	2.03	0.88	22.4	682	742	205	220	300	-	-	-	-	-	-	-	-	-	-	-	-	-	-	2½
114-24-2229	3/0	85.0	125	3.18	95	2.41	0.96	24.5	838	908	240	250	345	-	-	-	-	-	-	-	-	-	-	-	-	-	-	3
▲ 114-24-2231	4/0	107.0	125	3.18	95	2.41	0.97	24.6	991	1086	280	290	400	-	-	-	-	-	-	-	-	-	-	-	-	-	-	3
114-24-2233	250	127.0	140	3.56	110	2.79	1.08	27.4	1198	1293	315	320	445	-	-	-	-	-	-	-	-	-	-	-	-	-	-	3
▲ 114-24-2237	350	177.0	140	3.56	110	2.79	1.18	29.9	1555	1660	385	385	550	-	-	-	-	-	-	-	-	-	-	-	-	-	-	3½
▲ 114-24-2243	500	253.0	140	3.56	110	2.79	1.29	32.9	2075	2205	475	470	695	-	-	-	-	-	-	-	-	-	-	-	-	-	-	3½
▲ 114-24-2249	750	380.0	155	3.94	125	3.18	1.54	39.0	3034	3224	600	585	900	-	-	-	-	-	-	-	-	-	-	-	-	-	-	5
114-24-2251	1000	507.0	155	3.94	125	3.18	1.70	43.0	3891	4141	690	670	1075	-	-	-	-	-	-	-	-	-	-	-	-	-	-	5

* Marked "FAA L-824 5kV Type B".

Okonite's web site, www.okonite.com contains the most up to date information.

▲ Authorized stock item. Available from our Customer Service Center.

Aluminum Okopact Conductors

(1) Aluminum conductors are available on special order.

Ampacities

(2) Ampacities are in accordance with Table 315.60(C)(7) of the NEC for three single Type MV-90 conductors, or single conductors twisted together (triple) and installed in an isolated conduit in air at an ambient temperature of 40°C and a conductor temperature of 90°C.

(3) Ampacities are in accordance with Table 315.60(C)(11) of the NEC for three single conductors or triple conductor cable in one underground raceway, three feet deep with a conductor temperature of 90°C, 100% Load Factor, an ambient earth temperature of 20°C, and thermal resistance (RHO) of 90.

(4) Ampacities for cable in cable tray are in accordance with the NEC, Section 392.80(B)(2)(2), Table 315.60(C)(3) (copper), for single conductor cables installed in a single layer, in uncovered tray, with a maintained spacing of 1 cable OD or more at 90°C conductor temperature and 40°C ambient temperature.

Refer to the NEC, IEEE/ICEA-S-135 Power Cable Ampacities, or the Okonite Engineering Data Bulletin for other ambient temperatures, circuit configurations or installation requirements.

(5) Recommended size of rigid or nonmetallic conduit for three conductors based on 40% maximum fill.

* The jam ratio, conduit I.D. to cable O.D. should be checked to avoid possible jamming.

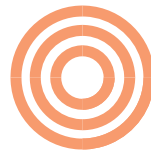

Okoguard®-Okoseal® Type MV-105 5/8kV Shielded Power Cable

One Okopact® (Compact Stranded) Copper Conductor/105°C Rating
5kV-133% or 8kV-100% Insulation Level
For Cable Tray Use-Sunlight Resistant



- A Uncoated, Okopact (Compact Stranded) Copper Conductor
- B Strand Screen-Extruded Semiconducting EPR
- C Insulation-Okoguard EPR
- D Insulation Screen-Extruded Semiconducting EPR
- E Shielding-Copper Tape
- F Jacket-Okoseal

Insulation

Okoguard is Okonite's registered trade name for its exclusive ethylene-propylene rubber (EPR) based, thermosetting compound, whose optimum balance of electrical and physical properties is unequaled in other solid dielectrics. Okoguard insulation, with the distinctive red color and a totally integrated EPR system, provides the optimum balance of electrical and physical properties for long, problem free service.

The triple tandem extrusion of the screens with the insulation provides optimum electrical characteristics.

Jacket

The Okoseal (PVC) jacket supplied with this cable is mechanically rugged and has excellent resistance to oil, acids and most chemicals.

Applications

Okoguard shielded Okoseal Type MV-105 power cables are recommended for use as feeder circuits, in electric utility generating stations, for distribution circuits, and for feeders or branch circuits in industrial and commercial installations. Type MV cables may be installed in wet or dry locations, indoors or outdoors (exposed to sunlight), in any raceway or underground duct, directly buried if installed in a system with a grounding conductor in close proximity that conforms with NEC Section 315.36 and 250.4(A)(5), or messenger supported in industrial establishments and electric utilities. Sizes 1/0 AWG and larger may also be installed in cable tray.

Specifications

Conductor: Annealed uncoated copper compact stranded per ASTM B-496.

Strand Screen: Extruded semiconducting EPR strand screen. Meets or exceeds electrical and physical requirements of ICEA S-93-639/NEMA WC74 & S-97-682, AEIC CS8, CSA C68.10 and UL 1072.

Insulation: Meets or exceeds electrical and physical requirements of ICEA S-93-639/NEMA WC74 & S-97-682, AEIC CS8, CSA C68.10 and UL 1072.

Insulation Screen: Extruded semiconducting EPR insulation screen applied directly over the insulation. Meets or exceeds electrical and physical requirements of ICEA S-93-639/NEMA WC74 & S-97-682, AEIC CS8, CSA C68.10 and UL 1072.

Shield: 5 mil bare copper tape helically applied with 25% minimum overlap.

Jacket: Meets or exceeds electrical and physical requirements of ICEA S-93-639/NEMA WC74 & S-97-682, CSA C68.10 and UL 1072 for polyvinyl chloride jackets.

UL listed as Type MV-105 and sunlight resistant, in accordance with UL 1072.

CSA C68.10 listed as FT4, SR, LTGG (-40°C), TC (< 500 kcmil) and TC-ER (≥ 500 kcmil).

Product Features

- Triple tandem extruded, all EPR system.
- Okoguard cables meet or exceed all recognized industry standards (UL, AEIC, NEMA/ICEA, IEEE).
- 105°C continuous operating temperature.
- 140°C emergency rating.
- 250°C short circuit rating.
- Passes UL and IEEE 383 and 1202 (1/0 AWG and larger) Vertical Tray Flame Test.
- Excellent corona resistance.
- Screens are clean stripping.
- Exceptional resistance to "treeing".
- Exceptional resistance to moisture.
- Resistant to most oils, acids, and alkalis.
- Sunlight resistant.
- For Cable Tray Use.
- Improved Temperature Rating.

Okoguard-Okoseal Type MV-105

5/8kV Shielded Power Cable

One Okopact (Compact Stranded)

Copper Conductor/ 105°C Rating Wet

5kV-133% or 8kV-100% Insulation Level

For Cable Tray Use-Sunlight Resistant



Product Data

Section 2: Sheet 3

Okoguard Insulation: 115 mils (2.92mm), 5kV-133% or 8kV-100% Insulation Level

Catalog Number (1)	Conductor size AWG or kcmil		Conductor Size -mm ²		Approx. Dia. over Insulation (in.)		Approx. Dia. over Screen (in.)		Jacket Thickness - mils		Jacket Thickness - mm		Approx. O.D. -Inches		Approx. O.D. -mm		Approx. Net Weight lbs./1000'		Approx. Ship Weight lbs./1000'		Ampacities Conduit in Air (2)			Ampacities Underground Duct (3)			Ampacities Cable Tray (4)			Conduit Size Inches (5)*		
▲ 114-23-3824	1/0	53.5	0.61	0.67	60	1.52	0.81	20.6	615	655	200	210	290	2½																		
▲ 114-23-3826	2/0	67.4	0.65	0.71	60	1.52	0.85	21.6	720	775	225	235	335	2½																		
114-23-3865	3/0	85.0	0.70	0.76	80	2.03	0.95	24.1	895	950	270	270	385	3																		
▲ 114-23-3832	4/0	107.0	0.75	0.81	80	2.03	0.99	25.2	1030	1090	305	310	445	3																		
▲ 114-23-3834	250	127.0	0.80	0.86	80	2.03	1.05	26.7	1185	1250	355	345	495	3																		
▲ 114-23-3838	350	177.0	0.89	0.95	80	2.03	1.14	29.0	1540	1625	430	415	610	3½																		
▲ 114-23-3846	500	253.0	1.01	1.07	80	2.03	1.26	32.0	2055	2155	530	505	765	3½																		
▲ 114-23-3873	750	380.0	1.19	1.26	80	2.03	1.45	36.9	2940	3120	665	630	990	4																		
114-23-3855	1000	507.0	1.34	1.40	80	2.03	1.59	40.4	3781	3960	770	720	1185	4																		

Okonite's web site, www.okonite.com contains the most up to date information.

▲ **Authorized stock item.** Available from our Customer Service Center.

Aluminum Conductors

(1) Aluminum conductors are available on special order.

Ampacities

(2) Ampacities are in accordance with Table 315.60(C)(7) of the NEC for three single Type MV-105 5kV conductors, or single conductors twisted together (triplexed) and installed in an isolated conduit in air at an ambient temperature of 40°C and a conductor temperature of 105°C. Refer to Table 315.60(C)(7) for 8kV ampacities.

(3) Ampacities are in accordance with Table 315.60(C)(11) of the NEC for three single 5kV conductors or triplexed cable in one underground raceway, three feet deep with a conductor temperature of 105°C, 100% Load Factor, an ambient earth temperature of 20°C, and thermal resistance (RHO) of 90. Refer to Table 315.60(C)(11) for 8kV ampacities.

(4) Ampacities for cable in cable tray are in accordance with the NEC, Section 392.80(B)(2)(2), Table 315.60(C)(3) (copper), for single conductor cables installed in a single layer, in uncovered tray, with a maintained spacing of 1 cable OD or more at 105°C conductor temperature and 40°C ambient temperature and single point grounding.

Refer to NEC, IEEE/ICEA-S-135 Power Cable Ampacities, or the Okonite Engineering Data Bulletin for installation in duct banks, multiple point grounded shields, other ambient temperatures, circuit configurations or installation requirements.

(5) Recommended size of rigid or nonmetallic conduit for three conductors based on 40% maximum fill.

* The jam ratio, conduit I.D. to cable O.D. should be checked to avoid possible jamming.



Okoguard®-Okoseal® Type MV-105 5/8kV Shielded Power Cable

One Okopact® (Compact Stranded) Copper Conductor/105°C Rating
5kV-133% or 8kV-100% Insulation Level



- A Uncoated, Okopact (Compact Stranded) Copper Conductor
- B Strand Screen-Extruded Semiconducting EPR
- C Insulation-Okoguard EPR
- D Insulation Screen-Extruded Semiconducting EPR
- E Shielding-Copper Tape
- F Jacket-Okoseal

Insulation

Okoguard is Okonite's registered trade name for its exclusive ethylene-propylene rubber (EPR) based, thermosetting compound, whose optimum balance of electrical and physical properties is unequalled in other solid dielectrics. Okoguard insulation, with the distinctive red color and a totally integrated EPR system, provides the optimum balance of electrical and physical properties for long, problem free service. The triple tandem extrusion of the screens with the insulation provides optimum electrical characteristics.

Jacket

The Okoseal (PVC) jacket supplied with this cable is mechanically rugged and has excellent resistance to oil, acids and most chemicals.

Applications

Okoguard shielded Okoseal Type MV-105 power cables are recommended for distribution circuits, and for feeders or branch circuits.

Type MV cables may be installed in wet or dry locations, indoors or outdoors (exposed to sunlight), in any raceway or underground duct, directly buried if installed in a system with a grounding conductor in close proximity that conforms with NEC Section 315.36 and 250.4(A)(5), or messenger supported in industrial establishments and electric utilities.

Specifications

Conductor: Annealed uncoated copper compact stranded per ASTM B-496.

Strand Screen: Extruded semiconducting EPR strand screen. Meets or exceeds electrical and physical requirements of ICEA S-93-639/NEMA WC74 & S-97-682, AEIC CS8, CSA C68.10 and UL 1072.

Insulation: Meets or exceeds electrical and physical requirements of ICEA S-93-639/NEMA WC74 & S-97-682, AEIC CS8, CSA C68.10 and UL 1072.

Insulation Screen: Extruded semiconducting EPR insulation screen applied directly over the insulation. Meets or exceeds electrical and physical requirements of ICEA S-93-639/NEMA WC74 & S-97-682, AEIC CS8, CSA C68.10 and UL 1072.

Shield: 5 mil bare copper tape helically applied with 12.5% nominal overlap.

Jacket: Meets or exceeds electrical and physical requirements of ICEA S-93-639/NEMA WC74 & S-97-682, CSA C68.10 and UL 1072 for polyvinyl chloride jackets.

UL Listed as Type MV-105 and sunlight resistant, in accordance with UL 1072. CSA C68.10 listed as FT1, SR, and LTDD (-25°C).

Product Features

- Triple tandem extruded, all EPR system.
- Okoguard cables meet or exceed all recognized industry standards (UL, AEIC, NEMA/ICEA, IEEE).
- 105°C continuous operating temperature.
- 140°C emergency rating.
- 250°C short circuit rating.
- Excellent corona resistance.
- Screens are clean stripping.
- Exceptional resistance to "treeing".
- Exceptional resistance to moisture.
- Resistant to most oils, acids, and alkalis.
- Sunlight resistant.
- Improved Temperature Rating.

Okoguard-Okoseal Type MV-105

5/8kV Shielded Power Cable

One Okopact (Compact Stranded)

Copper Conductor/ 105°C Rating

5kV-133% or 8kV-100% Insulation Level



Product Data

Section 2: Sheet 4

Okoguard Insulation: 115 mils (2.92mm), 5kV-133% or 8kV -100% Insulation

Catalog Number (1)	Conductor size AWG or kcmil		Conductor Size -mm ² Approx. Dia over Insulation (in.)		Approx. Dia. Over Screen (in.)		Jacket Thickness - mils Jacket Thickness - mm		Approx. O.D. -Inches Approx. O.D. -mm		Approx. Net Weight lbs./1000		Approx. Ship Weight lbs./1000		Ampacities Conduit in Air (2)	Ampacities Underground Duct (3)	Conduit Size Inches (4)*
▲ 114-23-3817	6	13.3	0.44	0.50	60	1.52	0.64	16.3	285	320	84	92	2				
▲ 114-23-3819	4	21.2	0.48	0.54	60	1.52	0.69	17.5	355	385	110	120	2				
▲ 114-23-3821	2	33.6	0.54	0.60	60	1.52	0.74	18.8	455	495	145	155	2				
114-23-3823	1	42.4	0.58	0.63	60	1.52	0.77	19.5	530	570	175	180	2½				
114-23-3825	1/0	53.5	0.61	0.67	60	1.52	0.81	20.6	610	645	200	210	2½				
114-23-3827	2/0	67.4	0.65	0.71	60	1.52	0.85	12.6	710	765	225	235	2½				
114-23-3829	3/0	85.0	0.70	0.75	80	2.03	0.93	23.6	880	935	270	270	3				
114-23-3831	4/0	107.0	0.75	0.81	80	2.03	0.99	25.1	1035	1100	305	310	3				
114-23-3833	250	127.0	0.80	0.86	80	2.03	1.04	26.4	1180	1245	355	345	3				
114-23-3837	350	177.0	0.89	0.95	80	2.03	1.14	29.0	1535	1625	430	415	3½				
114-23-3843	500	253.0	1.01	1.07	80	2.03	1.25	31.8	2050	2150	530	505	3½				
114-23-3849	750	380.0	1.19	1.25	80	2.03	1.43	36.8	2935	3110	665	630	4				
114-23-3851	1000	507.0	1.33	1.39	80	2.03	1.57	39.9	3650	3825	770	720	5				

Okonite's web site, www.okonite.com contains the most up to date information.

▲ **Authorized stock item.** Available from our Customer Service Centers.

Minimum Manufacturing Quantity for non-stock items is 5000'.

Aluminum Conductors

(1) Aluminum conductors are available on special order.

Ampacities

(2) Ampacities are in accordance with Table 315.60(C)(7) of the NEC for three single Type MV-105 5kV conductors or single conductors twisted together (triplexed) and installed in an isolated conduit in air at an ambient temperature of 40°C and a conductor temperature of 105°C. Refer to Table 315.60(C)(7) for 8kV ampacities.

(3) Ampacities are in accordance with Table 315.60(C)(11) of the NEC for three single 5kV conductors or triplexed cable in one underground raceway, three feet deep with a conductor temperature of 105°C, 100% Load Factor, an ambient earth temperature of 20°C, and thermal resistance (RHO) of 90. Refer to Table 315.60(C)(11) for 8kV ampacities.

Refer to the NEC, IEEE/ICEA S-135 Power Cable Ampacities, or the Okonite Engineering Data Bulletin for installation in duct banks, multiple point grounded shields, other ambient temperatures, circuit configurations or installation requirements.

(4) Recommended size of rigid or nonmetallic conduit for three conductors based on 40% maximum fill.

*The jam ratio, conduit I.D. to cable O.D. should be checked to avoid possible jamming.



Okoguard®-Okoseal® Type MV-105 15kV Shielded Power Cable

One Okopact® (Compact Stranded) Copper Conductor/105°C Rating
100% and 133% Insulation Level
For Cable Tray Use-Sunlight Resistant



- A Uncoated, Okopact (Compact Stranded) Copper Conductor
- B Strand Screen-Extruded Semiconducting EPR
- C Insulation-Okoguard EPR
- D Insulation Screen-Extruded Semiconducting EPR
- E Shield-Copper Tape
- F Jacket-Okoseal

Insulation

Okoguard is Okonite's registered trade name for its exclusive ethylene-propylene rubber (EPR) based, thermosetting compound, whose optimum balance of electrical and physical properties is unequalled in other solid dielectrics. Okoguard insulation, with the distinctive red color and a totally integrated EPR system, provides the optimum balance of electrical and physical properties for long, problem free service. The triple tandem extrusion of the screens with the insulation provides optimum electrical characteristics.

Jacket

The Okoseal (PVC) jacket supplied with this cable is mechanically rugged and has excellent resistance to flame, oil, acids and most chemicals.

Applications

Okoguard shielded Okoseal Type MV-105 power cables are recommended for use as feeder circuits, in electric utility generating stations, for distribution circuits, and for feeders or branch circuits in industrial and commercial installations. Type MV cables may be installed in wet or dry locations, indoors or outdoors (exposed to sunlight), in any raceway or underground duct, directly buried if installed in a system with a grounding conductor in close proximity that conforms with NEC Section 315.36 and 250.4(A)(5), or messenger supported in industrial establishments and electric utilities. Sizes 1/0 AWG and larger may also be installed in cable tray as permitted by NEC Section 315.32(3).

Specifications

Conductor: Annealed uncoated copper compact stranded per ASTM B-496.

Strand Screen: Extruded EPR semiconducting strand screen. Meets or exceeds electrical and physical requirements of ICEA S-93-639/NEMA WC74 & S-97-682, AEIC CS8, CSA C68.10 and UL 1072.

Insulation: Meets or exceeds electrical and physical requirements of ICEA S-93-639/NEMA WC74 & S-97-682, AEIC CS8, CSA C68.10 and UL 1072.

Insulation Screen: Extruded EPR semiconducting insulation screen applied directly over the insulation. Meets or exceeds electrical and physical requirements of ICEA

S-93-639/NEMA WC74 & S-97-682, AEIC CS8, CSA C68.10 and UL 1072.

Shield: 5 mil bare copper tape helically applied with 25% minimum overlap.

Jacket: Meets or exceeds electrical and physical requirements of ICEA S-93-639/NEMA WC74 & S-97-682, CSA C68.10 and UL 1072 for polyvinyl chloride jackets.

UL listed as Type MV-105, sunlight resistant, and for use in cable tray in accordance with UL 1072.

CSA C68.10 listed as FT4, SR, LTGG (-40°C), TC (< 500 kcmil) and TC-ER (≥ 500 kcmil).

Product Features

- Triple tandem extruded, all EPR system.
- Okoguard cables meet or exceed all recognized industry standards (UL, CSA, AEIC, NEMA/ICEA, IEEE).
- 105°C continuous operating temperature.
- 140°C emergency rating.
- 250°C short circuit rating.
- Passes the Vertical Tray Flame Test requirements of UL 1072 and IEEE 383 and 1202.
- Excellent corona resistance.
- Screens are clean stripping.
- Exceptional resistance to "treeing".
- Exceptional resistance to moisture.
- Resistant to most oils, acids, and alkalis.
- Sunlight resistant.
- For Cable Tray Use.
- Improved Temperature Rating.

Okoguard-Okoseal Type MV-105

15kV Shielded Power Cable

One Okopact (Compact Stranded)

Copper Conductor/ 105°C Rating

100% and 133% Insulation Level

For Cable Tray Use - Sunlight Resistant



Product Data Section 2: Sheet 8

Catalog Number (1)	Conductor size AWG or kcmil	Conductor Size -mm ²	Approx. Dia. over Insulation (in.)	Approx. Dia. over Screen (in.)	Jacket Thickness - mils	Jacket Thickness - mm	Approx. O.D. -Inches	Approx. O.D. -mm	Approx. Net Weight lbs./1000'	Approx. Ship Weight lbs./1000'	Ampacities (2) Conduit in Air	Ampacities (3) Underground Duct	Ampacities (4) Cable Tray	Conduit Size Inches (5)†
Okoguard Insulation: 175 mils (4.45mm), 100% Insulation Level														
115-23-3064	1/0	53.5	0.74	0.80	80	2.03	0.98	24.8	760	825	215	215	290	3
115-23-3066	2/0	67.4	0.78	0.84	80	2.03	1.02	25.8	870	935	255	245	335	3
115-23-3067	3/0	85.0	0.83	0.89	80	2.03	1.07	27.1	1005	1070	290	275	385	3
115-23-3069	4/0	107.0	0.88	0.94	80	2.03	1.12	28.4	1160	1240	330	315	445	3
115-23-3074	250	127.0	0.93	0.98	80	2.03	1.17	29.7	1330	1415	365	345	495	3½
115-23-3076	350	177.0	1.03	1.07	80	2.03	1.26	32.0	1700	1800	440	415	610	3½
115-23-3090	500	253.0	1.14	1.19	80	2.03	1.38	35.1	2230	2275	535	500	765	4
115-23-3091	750	380.0	1.32	1.37	80	2.03	1.55	39.4	3105	3340	655	610	990	5
115-23-3092	1000	507.0	1.47	1.52	80	2.03	1.71	43.4	3960	4215	755	690	1185	5

Okoguard Insulation: 220 mils (5.59mm), 133% Insulation Level

▲ 115-23-3479**	2	33.6	0.76	0.81	80	2.03	0.99	25.2	682	742	165	165	—	3
▲ 115-23-3230	1/0	53.5	0.83	0.88	80	2.03	1.10	28.0	905	975	215	215	290	3
▲ 115-23-3232	2/0	67.4	0.87	0.92	80	2.03	1.11	28.2	970	1030	255	245	335	3
115-23-3234	3/0	85.0	0.92	0.98	80	2.03	1.16	29.4	1170	1185	290	275	385	3½
▲ 115-23-3236	4/0	107.0	0.96	1.02	80	2.03	1.21	30.7	1280	1370	330	315	445	3½
▲ 115-23-3238	250	127.0	1.01	1.07	80	2.03	1.26	32.0	1435	1520	365	345	495	3½
▲ 115-23-3240	350	177.0	1.11	1.17	80	2.03	1.35	34.3	1810	1940	440	415	610	4
▲ 115-23-3242	500	253.0	1.22	1.28	80	2.03	1.47	37.3	2350	2535	535	500	765	4
▲ 115-23-3243	750	380.0	1.40	1.46	80	2.03	1.65	41.9	3240	3480	655	610	990	5
▲ 115-23-3244	1000	507.0	1.55	1.60	110	2.79	1.86	47.1	4220	4490	755	690	1185	6

Okonite's web site, www.okonite.com contains the most up to date information.

▲ **Authorized Stock Item.** Available from our Customer Service Centers. Minimum Manufacturing Quantity for non-stock items is 5000'.

Aluminum Conductors

(1) Aluminum conductors are available on special order. To order aluminum conductors, change the first three digits of the catalog number from 115 to 135.

Ampacities

(2) Ampacities are in accordance with Table 315.60(C)(7) of the NEC for three single Type MV-105 conductors, or single conductors twisted together (triplexed) and installed in an isolated conduit in air at an ambient temperature of 40°C and a conductor temperature of 105°C.

(3) Ampacities are in accordance with Table 315.60(C)(11) of the NEC for three single conductors or triplexed cable in one underground raceway, three feet deep with a conductor temperature of 105°C, 100% Load Factor, an ambient earth temperature of 20°C, and thermal resistance (RHO) of 90.

Refer to the NEC, IEEE/ICEA S-135 Power Cable Ampacities, or the Okonite Engineering Data Bulletin EHB for installation in duct banks, multiple point ground shields, other ambient temperatures, circuit configurations or installation requirements.

(4) Ampacities for cable in cable tray are in accordance with the NEC, Section 392.80(B)(2)(2), Table 315.60(C)(3) (copper), for single conductor cables installed in a single layer, in uncovered tray, with a maintained spacing of 1 cable OD or more at 105°C conductor temperature and 40°C ambient temperature and single point grounding.

(5) Recommended size of rigid or nonmetallic conduit for three conductors based on 40% maximum fill.

* The jam ratio, conduit I.D. to cable O.D. should be checked to avoid possible jamming.

**This cable is not recognized by UL for Cable Tray Use, FT4, -40°C, or CSA.



Okoguard®-Okoseal® Type MV-105

15kV Shielded Power Cable

One Aluminum Conductor/105°C Rating

100% and 133% Insulation Level

For Cable Tray Use-Sunlight Resistant



- A Uncoated Aluminum Conductor
- B Strand Screen-Extruded Semiconducting EPR
- C Insulation-Okoguard EPR
- D Insulation Screen-Extruded Semiconducting EPR
- E Shield-Copper Tape
- F Jacket-Okoseal

Insulation

Okoguard is Okonite's registered trade name for its exclusive ethylene-propylene rubber (EPR) based, thermosetting compound, whose optimum balance of electrical and physical properties is unequalled in other solid dielectrics. Okoguard insulation, with the distinctive red color and a totally integrated EPR system, provides the optimum balance of electrical and physical properties for long, problem free service. The triple tandem extrusion of the screens with the insulation provides optimum electrical characteristics.

Jacket

The Okoseal (PVC) jacket supplied with this cable is mechanically rugged and has excellent resistance to flame, oil, acids and most chemicals.

Applications

Okoguard shielded Okoseal Type MV-105 power cables are recommended for use as feeder circuits, in electric utility generating stations, for distribution circuits, and for feeders or branch circuits in industrial and commercial installations. Type MV cables may be installed in wet or dry locations, indoors or outdoors (exposed to sunlight), in any raceway or underground duct, directly buried if installed in a system with a grounding conductor in close proximity that conforms with NEC Section 315.36 and 250.4(A)(5), or messenger supported in industrial establishments and electric utilities. Sizes 1/0 AWG and larger may also be installed in cable tray as permitted by NEC Section 315.32(3).

Specifications

Conductor: Aluminum per ASTM B-609, Class B Stranded per B-231.

Strand Screen: Extruded EPR semiconducting strand screen. Meets or exceeds electrical and physical requirements of ICEA S-93-639/NEMA WC74 & S-97-682, AEIC CS8, CSA C68.10 and UL 1072.

Insulation: Meets or exceeds electrical and physical requirements of ICEA S-93-639/NEMA WC74 & S-97-682, AEIC CS8, CSA C68.10 and UL 1072.

Insulation Screen: Extruded EPR semiconducting insulation screen applied directly over the insulation. Meets or exceeds electrical and physical requirements of ICEA

S-93-639/NEMA WC74 & S-97-682, AEIC CS8, CSA C68.10 and UL 1072.

Shield: 5 mil bare copper tape helically applied with 25% minimum overlap.

Jacket: Meets or exceeds electrical and physical requirements of ICEA S-93-639/NEMA WC74 & S-97-682, CSA C68.10 and UL 1072 for polyvinyl chloride jackets.

UL listed as Type MV-105, sunlight resistant, and for use in cable tray in accordance with UL 1072.

CSA C68.10 listed as FT4, SR, LTGG (-40°C), TC (< 500 kcmil) and TC-ER (≥ 500 kcmil).

Product Features

- Triple tandem extruded, all EPR system.
- Okoguard cables meet or exceed all recognized industry standards (UL, CSA, AEIC, NEMA/ICEA, IEEE).
- 105°C continuous operating temperature.
- 140°C emergency rating.
- 250°C short circuit rating.
- Passes the Vertical Tray Flame Test requirements of UL 1072 and IEEE 383 and 1202.
- Excellent corona resistance.
- Screens are clean stripping.
- Exceptional resistance to "treeing".
- Exceptional resistance to moisture.
- Resistant to most oils, acids, and alkalis.
- Sunlight resistant.
- For Cable Tray Use.
- Improved Temperature Rating.
- Compact constructions available upon special request.

Okoguard-Okoseal Type MV-105

15kV Shielded Power Cable

One Aluminum Conductor/ 105°C Rating

100% and 133% Insulation Level

For Cable Tray Use - Sunlight Resistant



Product Data

Section 2: Sheet 59

Catalog Number	Conductor Size AWG or kcmil	Approx. Dia. over Insulation (in.)	Approx. Dia. over Screen (in.)	Jacket Thickness - mils	Jacket Thickness - mm	Approx. O.D. -Inches	Approx. O.D. -mm	Approx. Net Weight lbs./1000'	Approx. Ship Weight lbs./1000'	Ampacities (1) Conduit in Air	Ampacities (2) Underground Duct	Cable Tray (3)	Conduit Size Inches (4)*
Okoguard Insulation: 175 mils (4.45mm), 100% Insulation Level													
135-23-3202	1/0	0.75	0.82	80	2.03	1.00	25.4	562	638	170	165	225	3
135-23-3203	2/0	0.80	0.86	80	2.03	1.05	26.7	618	694	200	190	260	3*
135-23-3204	3/0	0.85	0.91	80	2.03	1.10	27.9	683	775	225	215	300	3
135-23-4021	4/0	0.90	0.96	80	2.03	1.15	29.2	763	830	260	245	345	3½
135-23-3206	250	0.97	1.03	80	2.03	1.22	31.0	846	939	290	270	380	3½*
135-23-4027	350	1.07	1.13	80	2.03	1.32	33.5	1012	1126	350	330	475	4*
135-23-4031	500	1.20	1.26	80	2.03	1.45	36.8	1237	1389	430	400	590	4*
135-23-4035	750	1.39	1.45	80	2.03	1.64	41.7	1612	1799	540	490	763	5
135-23-3210	1000	1.54	1.60	110	2.79	1.85	47.0	2059	2441	640	565	920	6
135-23-9784	1100	1.52	1.58	110	2.79	1.83	46.5	2110	2364	675	575	1055	6
Okoguard Insulation: 220 mils (5.59mm), 133% Insulation Level													
135-23-3301	1/0	0.85	0.91	80	2.03	1.01	25.7	656	748	170	165	225	3
135-23-3302	2/0	0.89	0.95	80	2.03	1.14	29.0	715	807	200	190	260	3½
135-23-3303	3/0	0.94	1.00	80	2.03	1.19	30.2	784	877	225	215	300	3½*
▲ 135-23-3107	4/0	0.99	1.05	80	2.03	1.24	31.5	869	953	260	245	345	3½*
135-23-3305	250	1.06	1.12	80	2.03	1.31	33.3	958	1066	290	270	380	4
▲ 135-23-3174	350	1.16	1.22	80	2.03	1.41	35.8	1132	1248	350	330	475	4
▲ 135-23-3175	500	1.29	1.35	80	2.03	1.54	39.1	1368	1548	430	400	590	5
▲ 135-23-3176	750	1.49	1.55	80	2.03	1.73	43.9	1758	1967	540	490	765	5
135-23-3309	1000	1.64	1.70	110	2.79	1.95	49.5	2223	2605	640	565	920	6*
135-23-9794	1100	1.61	1.67	110	2.79	1.92	48.8	2273	2580	675	575	1055	6

Okonite's web site, www.okonite.com contains the most up to date information.

▲ **Authorized Stock Item.** Available from our Customer Service Centers. Minimum Manufacturing Quantity for non-stock items is 5000'.

Ampacities

(1) Ampacities are in accordance with Table 315.60(C)(8) of the NEC for three single Type MV-105 conductors, or single conductors twisted together (triplexed) and installed in an isolated conduit in air at an ambient temperature of 40°C and a conductor temperature of 105°C.

(2) Ampacities are in accordance with Table 315.60(C)(12) of the NEC for three single conductors or triplexed cable in one underground raceway, three feet deep with a conductor temperature of 105°C, 100% Load Factor, an ambient earth temperature of 20°C, and thermal resistance (RHO) of 90.

Refer to the NEC, IEEE/ICEA S-135 Power Cable Ampacities, or the Okonite Engineering Data Bulletin EHB for installation in duct banks, multiple point ground shields, other ambient temperatures, circuit configurations or installation requirements.

(3) Table 315.60(C)(4) (Aluminum), for single conductor cables installed in a single layer, in uncovered tray, with a maintained spacing of 1 cable OD or more at 105°C conductor temperature and 40°C ambient temperature and single point grounding.

(4) Recommended size of rigid or nonmetallic conduit for three conductors based on 40% maximum fill.

* The jam ratio, conduit I.D. to cable O.D. should be checked to avoid possible jamming.



Okoguard®-Okolon® TS-CPE Type MV-105 15kV Shielded Power Cable

One Okopact® (Compact Stranded) Copper Conductor/105°C Rating
100% and 133% Insulation Level

For Cable Tray Use-Sunlight Resistant



- A Uncoated, Okopact (Compact Stranded) Copper Conductor
- B Strand Screen-Extruded Semiconducting EPR
- C Insulation-Okoguard EPR
- D Insulation Screen-Extruded Semiconducting EPR
- E Shield Copper Tape
- F Jacket-Okolon TS-CPE

Insulation

Okoguard is Okonite's registered trade name for its exclusive ethylene-propylene (EPR) based, thermosetting compound, whose optimum balance of electrical and physical properties is unequalled in other solid dielectrics. Okoguard insulation, with the distinctive red color and a totally integrated EPR system, provides the optimum balance of electrical and physical properties for long, problem free service. The triple tandem extrusion of the screens with the insulation provides optimum electrical characteristics.

Jacket

The Okolon TS-CPE jacket on this cable is a vulcanized chlorinated polyethylene base compound which is mechanically rugged, flame, radiation, and oil resistant.

Applications

Okoguard shielded Okolon TS-CPE Type MV-105 power cables are recommended for use as feeder circuits in electric utility generating stations, for distribution circuits, and for feeders or branch circuits in industrial and commercial installations. Type MV cables may be installed in wet or dry locations, indoors or outdoors (exposed to sunlight), in any raceway or underground duct, directly buried if installed in a system with a grounding conductor in close proximity that conforms with NEC Section 315.36 and 250.4(A)(5), or messenger supported in industrial establishments and electric utilities. Sizes 1/0 AWG and larger may also be installed in cable tray.

Specifications

Conductor: Annealed uncoated copper compact stranded per ASTM B-496.

Strand Screen: Extruded semiconducting EPR strand screen. Meets or exceeds electrical and physical requirements of ICEA S-93-639/NEMA WC74 & S-97-682, AEIC CS8, CSA C68.10 and UL 1072.

Insulation: Meets or exceeds electrical and physical requirements of ICEA S-93-639/NEMA WC74 & S-97-682, AEIC CS8, CSA C68.10 and UL 1072.

Insulation Screen: Extruded semiconducting EPR insulation screen. Meets or exceeds

electrical and physical requirements of ICEA S-93-639/NEMA WC74 & S-97-682, AEIC CS8, CSA C68.10 and UL 1072.

Shield: 5 mil bare copper tape helically applied, with 25% minimum overlap.

Jacket: Meets or exceeds electrical and physical requirements of ICEA S-93-639/NEMA WC74 & S-97-682, CSA C68.10 and UL 1072 for chlorinated polyethylene jackets.

UL listed as Type MV-105, sunlight resistant and for use in cable tray in accordance with UL 1072.

CSA C68.10 listed as FT4, SR, LTDD (-25°C), and TC (1/0 AWG & larger).

Product Features

- Triple tandem extruded, all EPR system.
- Okoguard cables meet or exceed all recognized industry standards (UL, AEIC, NEMA/ICEA, IEEE).
- 105°C continuous operating temperature.
- 140°C emergency rating.
- 250°C short circuit rating.
- Passes UL and IEEE 383 and 1202 (1/0 AWG & larger) Vertical Tray Flame Tests.
- Excellent corona resistance.
- Screens are clean stripping.
- Exceptional resistance to "treeing."
- Moisture resistant.
- Resistant to most oils, acids, and alkalis.
- Sunlight resistant.
- UL listed For Cable Tray Use; 1/0 AWG & larger.
- Improved Temperature Rating.

Okoguard-Okolon TS-CPE Type MV-105

15kV Shielded Power Cable

One Okopact (Compact Stranded)

Copper Conductor/ 105°C Rating

100% and 133% Insulation Level

For Cable Tray Use-Sunlight Resistant

Product Data Section 2: Sheet 11



Catalog Number (1)	Conductor Size AWG or kcmil		Conductor Size - mm ²		Approx. Dia. over Insulation (in.)		Approx. Dia. over Screen (in.)		Jacket Thickness - mils		Approx. O.D. - mm		Approx. O.D. - Inches		Approx. Net Weight (lbs./1000')		Approx. Ship Weight (lbs./1000')		Ampacities (2) Conduit in Air		Ampacities (3) Underground		Ampacities (4) Cable Tray		Conduit (5) Size Inches*	
--------------------	--------------------------------	--	----------------------------------	--	---------------------------------------	--	-----------------------------------	--	----------------------------	--	-------------------	--	-----------------------	--	------------------------------------	--	-------------------------------------	--	----------------------------------	--	-------------------------------	--	------------------------------	--	-----------------------------	--

Okoguard Insulation: 175 mils (4.45mm), 100% Insulation Level

115-23-2011	2	33.6	0.67	0.73	60	1.52	0.89	22.5	585	640	165	165	—	3
115-23-2013	1	42.4	0.70	0.76	80	2.03	0.96	24.4	700	765	190	185	—	3
115-23-2015	1/0	53.5	0.73	0.79	80	2.03	1.00	25.3	790	855	215	215	290	3
115-23-2017	2/0	67.4	0.77	0.83	80	2.03	1.04	26.4	905	965	255	245	335	3
115-23-2019	3/0	85.0	0.82	0.88	80	2.03	1.09	27.6	1040	1110	290	275	385	3
115-23-2021	4/0	107.0	0.87	0.93	80	2.03	1.13	28.7	1200	1280	330	315	445	3½
115-23-2023	250	127.0	0.93	0.99	80	2.03	1.19	30.3	1370	1450	365	345	495	3½
115-23-2027	350	177.0	1.01	1.07	80	2.03	1.28	32.4	1725	1825	440	415	610	4
115-23-2031	500	253.0	1.13	1.19	80	2.03	1.39	35.4	2255	2370	535	500	765	4
115-23-2035	750	380.0	1.31	1.37	80	2.03	1.57	39.9	3140	3320	655	610	990	5
115-23-2038	1000	507.0	1.46	1.52	80	2.03	1.73	43.9	4020	4255	755	690	1185	5

Okoguard Insulation: 220 mils (5.59mm), 133% Insulation Level

115-23-2111	2	33.6	0.75	0.81	80	2.03	1.01	25.8	710	775	165	165	—	3
115-23-2113	1	42.4	0.79	0.85	80	2.03	1.05	26.7	790	860	190	185	—	3
115-23-2115	1/0	53.5	0.82	0.88	80	2.03	1.08	27.5	880	945	215	215	290	3½
115-23-2117	2/0	67.4	0.86	0.92	80	2.03	1.12	28.5	995	1075	255	245	335	3½
115-23-2119	3/0	85.0	0.91	0.97	80	2.03	1.18	29.9	1145	1225	290	275	385	3½
115-23-2121	4/0	107.0	0.96	1.02	80	2.03	1.22	31.1	1310	1400	330	315	445	3½
115-23-2123	250	127.0	1.01	1.07	80	2.03	1.28	32.4	1465	1565	365	345	495	4
115-23-2127	350	177.0	1.10	1.16	80	2.03	1.37	34.7	1840	1940	440	415	610	4
▲ 115-23-2131	500	253.0	1.22	1.28	80	2.03	1.49	37.7	2385	2570	535	500	765	5
▲ 115-23-2135	750	380.0	1.40	1.46	80	2.03	1.66	42.2	3285	3540	655	610	990	5
115-23-2138	1000	507.0	1.54	1.60	110	2.79	1.87	47.5	4275	4540	755	690	1185	6
115-23-2144	1250	633.5	1.75	1.81	110	4.33	2.08	52.7	5255	5645	845	770	1350	6
115-23-2145	1500	760.2	1.88	1.94	110	4.33	2.20	56.0	6140	6540	925	845	1500	8

Okonite's web site, www.okonite.com contains the most up to date information.

▲ **Authorized Stock Item.** Available from our Customer Service Centers.

Aluminum Conductors

(1) Aluminum conductors are available on special order.

Ampacities

(2) Ampacities are in accordance with Table 315.60(C)(7) of the NEC for three single Type MV-105 conductors, or single conductors twisted together (triplexed) and installed in an isolated conduit in air at an ambient temperature of 40°C and a conductor temperature of 105°C.

(3) Ampacities are in accordance with Table 315.60(C)(11) of the NEC for three single conductors or triplexed cable in one underground raceway, three feet deep with a conductor temperature of 105°C, 100% Load Factor, an ambient earth temperature of 20°C and thermal resistance (RHO) of 90.

(4) Ampacities for cable in cable tray are in accordance with the NEC, Section 392.80(B)(2)(2), Table 315.60(C)(3) (copper), for single conductor cables installed in a single layer, in uncovered tray, with a maintained spacing of 1 cable

OD or more at 105°C conductor temperature and 40°C ambient temperature and single point grounding.

Refer to the NEC, IEEE/ICEA-S-135 Power Cable Ampacities, or the Okonite Engineering Data Bulletin for installation in duct banks, multiple point grounded shields, other ambient temperatures, circuit configurations or installation requirements.

(5) Recommended size of rigid or nonmetallic conduit for three conductors based on 40% maximum fill.

*The jam ratio conduit I.D. to cable O.D. should be checked to avoid possible jamming.

 **THE OKONITE COMPANY**
Ramsey, New Jersey 07446



Okoguard®-Okoseal® Type MV-105 35kV Shielded Power Cable

One Okopact® (Compact Stranded) Copper Conductor/105°C Rating
100% and 133% Insulation Level
For Cable Tray Use-Sunlight Resistant



- A Uncoated, Okopact (Compact Stranded) Copper Conductor
- B Strand Screen-Extruded Semi-conducting EPR
- C Insulation-Okoguard EPR
- D Insulation Screen-Extruded Semi-conducting EPR
- E Shield- Copper Tape
- F Jacket-Okoseal

Insulation

Okoguard is Okonite's registered trade name for its exclusive ethylene-propylene rubber (EPR) based, thermosetting compound, whose optimum balance of electrical and physical properties is unequaled in other solid dielectrics. Okoguard insulation, with the distinctive red color and a totally integrated EPR system, provides the optimum balance of electrical and physical properties for long, problem free service.

The triple tandem extrusion of the screens with the insulation provides optimum electrical characteristics.

Jacket

The Okoseal (PVC) jacket supplied with this cable is mechanically rugged and has excellent resistance to flame, oil, acids and most chemicals.

Applications

Okoguard shielded Okoseal Type MV-105 power cables are recommended for use as feeder circuits, in electric utility generating stations, for distribution circuits, and for feeders or branch circuits in industrial and commercial installations.

Type MV cables may be installed in wet or dry locations, indoors or outdoors (exposed to sunlight), in any raceway or underground duct, directly buried if installed in a system with a grounding conductor in close proximity that conforms with NEC Section 250.4(A)(5) and 315.36, or messenger supported in industrial establishments and electric utilities. Sizes 1/0 AWG and larger may also be installed in cable tray.

Specifications

Conductor: Annealed uncoated copper compact stranded per ASTM B-496.

Strand Screen: Extruded EPR semiconducting strand screen. Meets or exceeds electrical and physical requirements of ICEA S-93-639/NEMA WC74 & S-97-682, AEIC CS8, CSA C68.10 and UL 1072.

Insulation: Meets or exceeds electrical and physical requirements of ICEA S-93-639/NEMA WC74 & S-97-682, AEIC CS8, CSA C68.10 and UL 1072.

Insulation Screen: Extruded EPR semiconducting insulation screen applied directly over the insulation. Meets or exceeds electrical and physical requirements of ICEA S-93-639/NEMA WC74 & S-97-682, AEIC CS8, CSA C68.10 and UL 1072.

Shield: 5 mil bare copper tape helically applied with 25% minimum overlap.

Jacket: Meets or exceeds electrical and physical requirements of ICEA S-93-639/NEMA WC74 & S-97-682, CSA C68.10 and UL 1072 for polyvinyl chloride jackets.

UL listed as Type MV-105, sunlight resistant, and for use in cable tray in accordance with UL 1072.

CSA C68.10 listed as FT4, SR, LTGG (-40°C), TC (< 500 kcmil) and TC-ER (≥500 kcmil).

Product Features

- Triple tandem extruded, all EPR system.
- Okoguard cables meet or exceed all recognized industry standards (UL, CSA, AEIC, NEMA/ICEA, IEEE).
- 105°C continuous operating temperature.
- 140°C emergency rating.
- 250°C short circuit rating.
- Passes the Vertical Tray Flame Test requirements of UL 1072 and IEEE 383 and 1202.
- Excellent corona resistance.
- Screens are clean stripping.
- Exceptional resistance to "treeing".
- Exceptional resistance to moisture.
- Resistant to most oils, acids, and alkalis.
- Sunlight resistant.
- For Cable Tray Use.
- Improved Temperature Rating.

Okoguard -Okoseal Type MV-105

35kV Shielded Power Cable

One Okopact (Compact Stranded)

Copper Conductor/105°C Rating

100% and 133% Insulation Level

For Cable Tray Use-Sunlight Resistant



Product Data Section 2: Sheet 57

Catalog Number (1)	Conductor size AWG or kcmil	Conductor Size - mm ²	Approx. Dia. over Insulation (in.)	Approx. Dia. over Screen (in.)	Jacket Thickness - mils	Jacket Thickness - mm	Approx. O.D. - Inches	Approx. O.D. - mm	Approx. Net Weight lbs./1000'	Approx. Ship Weight lbs./1000'	Ampacities (2) Conduit in Air	Ampacities (3) Underground Duct	Ampacities (4) Cable Tray	Conduit Size Inches (5)
Okoguard Insulation: 345 mils (8.763mm), 100% Insulation Level														
▲ 115-23-3402	1/0	53.5	1.09	1.15	80	2.03	1.34	34.1	1168	1286	215	215	290	4
115-23-3406	2/0	67.4	1.13	1.19	80	2.03	1.38	35.1	1292	1444	255	245	335	4
115-23-3407	3/0	85.0	1.18	1.24	80	2.03	1.43	32.3	1444	1596	290	275	385	4
▲ 115-23-3409	4/0	107.0	1.23	1.29	80	2.03	1.48	37.6	1628	1789	330	315	445	5
115-23-3414	250	127.0	1.28	1.33	80	2.03	1.53	28.8	1789	1973	365	345	495	5
115-23-3416	350	177.0	1.37	1.43	80	2.03	1.62	41.1	2183	2370	440	415	610	5
▲ 115-23-3440	500	253.0	1.48	1.54	80	2.03	1.73	43.9	2732	2960	535	500	765	5
115-23-3441	750	380.0	1.67	1.73	110	2.79	1.98	50.3	3799	4104	655	610	990	6
115-23-3442	1000	507.0	1.87	1.85	110	2.79	2.12	58.8	4708	5833	755	690	1185	6
Okoguard Insulation: 420 mils (10.668mm), 133% Insulation Level														
▲ 115-23-3422	1/0	53.5	1.25	1.31	80	2.03	1.50	38.1	1380	1541	215	215	290	5
▲ 115-23-3426	2/0	67.4	1.29	1.35	80	2.03	1.54	39.1	1509	1693	255	245	335	5
115-23-3427	3/0	85.0	1.34	1.40	80	2.03	1.59	40.4	1667	1851	290	275	385	5
▲ 115-23-3439	4/0	107.0	1.39	1.45	80	2.03	1.64	41.6	1859	2046	330	315	445	5
115-23-3444	250	127.0	1.44	1.50	80	2.03	1.68	42.7	2026	2213	365	345	495	5
▲ 115-23-3446	350	177.0	1.53	1.59	110	2.79	1.84	46.7	2540	2777	440	415	610	5
▲ 115-23-3750	500	253.0	1.63	1.69	110	2.79	1.94	49.3	3100	3405	535	500	765	6
▲ 115-23-3751	750	380.0	1.82	1.90	110	2.79	2.13	54.2	4099	4476	655	610	990	6
115-23-3752	1000	507.0	1.97	2.03	110	2.79	2.28	57.9	5029	5888	755	690	1185	8

Okonite's web site, www.okonite.com contains the most up to date information.

▲ **Authorized stock item.** Available from our Customer Service Centers.

Aluminum Conductors

(1) Aluminum conductors are available on special order. To order aluminum conductors, change the first three digits of the catalog number from 115 to 135.

Ampacities

(2) Ampacities are in accordance with Table 315.60(C)(7) of the NEC for three single Type MV-105 conductors, or single conductors twisted together (triplexed) and installed in an isolated conduit in air at an ambient temperature of 40°C and a conductor temperature of 105°C.

(3) Ampacities are in accordance with Table 315.60(C)(11) of the NEC for three single conductors or triplexed cable in one underground raceway, three feet deep with a conductor temperature of 105°C, 100% Load Factor, an ambient earth temperature of 20°C, and thermal resistance (RHO) of 90.

Refer to the NEC, IEEE/CEA S-135 Power Cable Ampacities, or the Okonite Engineering Data Bulletin EHB for installation in duct banks, multiple point ground shields, other ambient temperatures, circuit configurations or installation requirements.

(4) Ampacities for cable in cable tray are in accordance with the NEC, Section 392.80(B)(2)(2), Table 315.60(C)(3) (copper), for single conductor cables installed in a single layer, in uncovered tray, with a maintained spacing of 1 cable OD or more at 105°C conductor temperature and 40°C ambient temperature and single point grounding.

(5) Recommended size of rigid or nonmetallic conduit for three conductors based on 40% maximum fill.

*The jam ratio, conduit I.D. to cable O.D. should be checked to avoid possible jamming.



Okoguard®-Okoseal® 69kV Shielded Power Cable

Conductor/105°C Rating



- A Uncoated, Okopact (Compact) or Compress Stranded Copper or Aluminum Conductor
- B Strand Screen-Extruded Semiconducting EPR
- C Insulation-Okoguard EPR
- D Insulation Screen-Extruded Semiconducting EPR
- E Metallic Shield-5 mil Bare Copper Tape
- F Jacket-Okoseal

Insulation

Okoguard® is Okonite's registered trade name for its exclusive ethylene-propylene rubber (EPR) based, thermosetting compound, whose optimum balance of electrical and physical properties is unequaled in other solid dielectrics. Okoguard insulation, with the distinctive red color and a totally integrated EPR system, provides the optimum balance of electrical and physical properties for long, problem-free service.

Ethylene-propylene rubber screens are extruded over the conductor and the insulation. The triple tandem extrusion of these screens with the insulation provides optimum electrical characteristics.

Jacket

The Okoseal (PVC) jacket supplied with this cable is mechanically rugged and has excellent resistance to oil and most chemicals.

Applications

Okoguard-Shielded-Okoseal 69kV Cables are designed for use as primary circuits in electrical utility and industry applications where they provide maximum circuit security and economical installation. Rated 105°C for continuous operating temperature, Okoguard 69kV cables may be installed in wet or dry locations indoors or outdoors (exposed to sunlight) in underground ducts, conduits or direct burial.

Specifications

Conductors: Uncoated copper sizes 250 through 1000 kcmil are compact round strand per ASTM B496. Uncoated copper sizes larger than 1000 kcmil are compressed round Class B strand per ASTM B3 and ASTM B8. Aluminum sizes are compressed round Class B strand per ASTM B231 and ASTM B609.

Strand Screen: Extruded semiconducting EPR strand screen. Meets or exceeds electrical and physical requirements of ICEA S-108-720 and AEIC CS9.

Insulation: Meets or exceeds electrical and physical requirements of ICEA S-108-720 and AEIC CS9.

Insulation Screen: Extruded semiconducting EPR insulation screen. Meets or exceeds electrical and physical requirements of ICEA S-108-720 and AEIC CS9.

Shield: 5 mil bare copper tape helically applied with 25% nominal overlap.

Jacket: Meets or exceeds electrical and physical requirements of ICEA S-108-720 for polyvinyl chloride jackets.

Optional jackets include Okolene®, Okolon® TS-CPE, Okoclear® and when specified, a semi-conducting outer layer.

Optional shields include concentric neutral wires, LCS and a combination of copper tape and wires. A C-L-X® armor covering is also available.

Product Features

- Triple tandem extruded, all EPR system.
- Okoguard cables meet or exceed recognized industry standards (AEIC and ICEA).
- 105°C continuous operating temperature.
- 140°C emergency rating.
- 250°C short circuit rating.
- Excellent corona resistance.
- Exceptional resistance to "treeing."
- Low shield resistance.
- Moisture resistant.
- Resistant to most oils, acids, and alkalis.
- Sunlight resistant.
- Improved temperature rating.
- Screens are clean stripping.
- Production testing and associated frequency to be performed in accordance with ICEA S-108-720, latest edition.
- Stock cables have strippable insulation screen.
- Special order cables are available with strippable or bonded insulation screen.

Okoguard Insulation: 650 mils(16.5mm)

Catalog Number	Conductor size AWG or kcmil	Conductor Size -mm ²	Approx. Dia. over Insulation (in.)	Approx. Dia. over Screen (in.)	Jacket Thickness - mils	Jacket Thickness - mm	Approx. O.D. -Inches	Approx. O.D. -mm	Approx. Net Weight lbs./1000'	Approx. Ship Weight lbs./1000'	Ampacity Ductbank (1)	Ampacity Direct Bury (1)	Conduit Size Inches (2)*
Copper Conductor - Compact Round													
115-22-3765	250(37x)	127	1.91	2.01	110	2.79	2.26	57.4	3086	3459	458	508	3½
115-22-3767	350(37x)	177	2.01	2.11	110	2.79	2.36	59.9	3538	3873	555	616	3½
▲ 115-22-3771	500(37x)	253	2.12	2.22	110	2.79	2.47	62.7	4179	4514	678	753	3½
115-22-3775	750(61x)	380	2.30	2.40	110	2.79	2.64	67.1	5213	5805	853	943	4
▲ 115-22-3777	1000(61x)	507	2.44	2.54	140	3.56	2.85	72.4	6406	7098	993	1095	4
Copper Conductor Compressed Round													
115-22-3778	1250(91x)	633	2.68	2.78	140	3.56	3.09	78.5	7531	8451	1133	1234	5
115-22-3779	1500(91x)	761	2.78	2.88	140	3.56	3.19	81.0	8527	9447	1244	1351	5
115-22-3780	1750(127x)	887	2.91	3.01	140	3.56	3.32	84.3	9664	10686	1342	1455	5
115-22-3781	2000(127x)	1014	3.03	3.13	140	3.56	3.44	87.4	10651	11850	1424	1542	5
115-22-3782	2250(127x)	1140	3.14	3.24	140	3.56	3.55	90.2	11563	14375	1502	1622	5
155-22-3783	2500(127x)	1267	3.21	3.31	140	3.56	3.62	91.9	12609	15007	1566	1689	5
155-22-3784	2750(127x)	1393	3.30	3.40	140	3.56	3.71	94.2	13548	15946	1643	1752	6

Okonite's web site, www.okonite.com contains the most up to date information.

Additional conductor sizes are available.

▲ **Authorized Stock Item.** Available from our Customer Service Centers.

(1) Ampacities Conditions

Ampacities are calculated using the Neher-McGrath methods of estimating the steady-state temperature of electrical power cables with the IEEE 835-1994 configurations noted below.

Duct Bank:

69kV 250-3000 kcmil
 Configuration: 3 single cables in geometry (g).
 Single circuit underground duct with 12" spacing between conductors.
 Single duct bank, 30" to top of duct bank, 75% Load Factor, 60°C-cm/W (RHO) concrete.
 Ambient temperature of 20°C and soil thermal resistivity (RHO) of 90°C-cm/W.

Direct Burial:

69kV 250-3000 kcmil
 Configuration: 3 single cables in geometry (k).
 Single circuit directly buried 36" deep underground with 7 1/2" flat spacing between conductors.
 75% Load Factor, ambient temperature of 20°C and soil thermal resistivity (RHO) of 90°C-cm/W.
 Multi-point grounded except copper sizes 1500, 1750, 2000, 2250, 2500 and 2750 kcmil and aluminum sizes 2000, 2250, 2500, 2750 and 3000 where the shields are open circuit.

Ampacities for other configurations available upon request. Contact your local Okonite sales representative.

(2) Recommended size of rigid nonmagnetic or nonmetallic conduit for a single conductor based on 53% maximum fill.

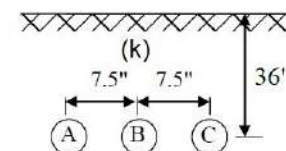
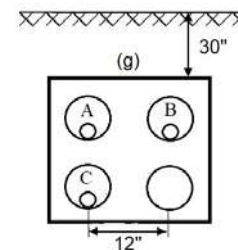

Okoguard Insulation: 650 mils(16.5mm)

Catalog Number	Conductor size AWG or kcmil	Conductor Size -mm ²	Approx. Dia. over Insulation (in.)	Approx. Dia. over Screen (in.)	Jacket Thickness - mils	Jacket Thickness - mm	Approx. O.D. -Inches	Approx. O.D. -mm	Approx. Net Weight lbs./1000'	Approx. Ship Weight lbs./1000'	Ampacity Ductbank (1)	Ampacity Direct Bury (1)	Conduit Size Inches (2)*
Aluminum Conductor - Compress Round													
135-22-3765	250(37x)	127	1.94	2.04	110	2.79	2.29	58.2	2587	2960	361	401	3½
135-22-3767	350(37x)	177	2.06	2.16	110	2.79	2.41	61.2	2888	3223	437	486	3½
135-22-3771	500(37x)	253	2.19	2.29	110	2.79	2.54	64.5	3244	3579	535	596	3½
135-22-3775	750(61x)	380	2.37	2.47	110	2.79	2.72	69.1	3778	4175	678	750	4
135-22-3777	1000(61x)	507	2.52	2.62	140	3.56	2.93	74.4	4433	4904	793	876	4
135-22-3778	1250(91x)	633	2.68	2.78	140	3.56	3.09	78.5	4954	5716	904	987	5
135-22-3779	1500(91x)	761	2.80	2.90	140	3.56	3.21	81.5	5381	6034	998	1088	5
135-22-3790	1750(127x)	887	2.93	3.03	140	3.56	3.34	84.8	5909	6931	1088	1185	5
135-22-3791	2000(127x)	1014	3.03	3.13	140	3.56	3.44	87.4	6330	7529	1167	1267	5
135-22-3792	2250(127x)	1140	3.12	3.22	140	3.56	3.52	89.4	6726	8637	1237	1342	5
135-22-3793	2500(127x)	1267	3.21	3.31	140	3.56	3.62	91.9	7150	9061	1304	1412	5
135-22-3794	2750(127x)	1393	3.30	3.40	140	3.56	3.71	94.2	7545	9456	1377	1474	6
135-22-3795	3000(169x)	1520	3.39	3.49	140	3.56	3.79	96.3	7919	9830	1434	1532	6

Okonite's web site, www.okonite.com contains the most up to date information.

Additional conductor sizes are available.

▲ **Authorized Stock Item.** Available from our Customer Service Centers.

(1) Ampacities Conditions

Ampacities are calculated using the Neher-McGrath methods of estimating the steady-state temperature of electrical power cables with the IEEE 835-1994 configurations noted below.

Duct Bank:

69kV 250-3000 kcmil
 Configuration: 3 single cables in geometry (g).
 Single circuit underground duct with 12" spacing between conductors.
 Single duct bank, 30" to top of duct bank, 75% Load Factor, 60°C-cm/W (RHO) concrete.
 Ambient temperature of 20°C and soil thermal resistivity (RHO) of 90°C-cm/W.

Direct Burial:

69kV 250-3000 kcmil
 Configuration: 3 single cables in geometry (k).
 Single circuit directly buried 36" deep underground with 7 1/2" flat spacing between conductors.
 75% Load Factor, ambient temperature of 20°C and soil thermal resistivity (RHO) of 90°C-cm/W.

Multi-point grounded except copper sizes 1500, 1750, 2000, 2250, 2500 and 2750 kcmil and aluminum sizes 2000, 2250, 2500, 2750 and 3000 where the shields are open circuit.

Ampacities for other configurations available upon request. Contact your local Okonite sales representative.

(2) Recommended size of rigid nonmagnetic or nonmetallic conduit for a single conductor based on 53% maximum fill.

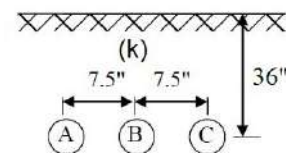
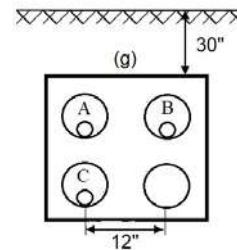

THIS PAGE INTENTIONALLY LEFT BLANK



Okoguard®-Okoseal® Type MV-105 5/8kV Okoguard Shielded Power Cable



3 Okopact® (Compact Stranded) Copper Conductor/105°C Rating
5kV-133% or 8kV-100% Insulation Level

For Cable Tray Use-Sunlight Resistant-For Direct Burial

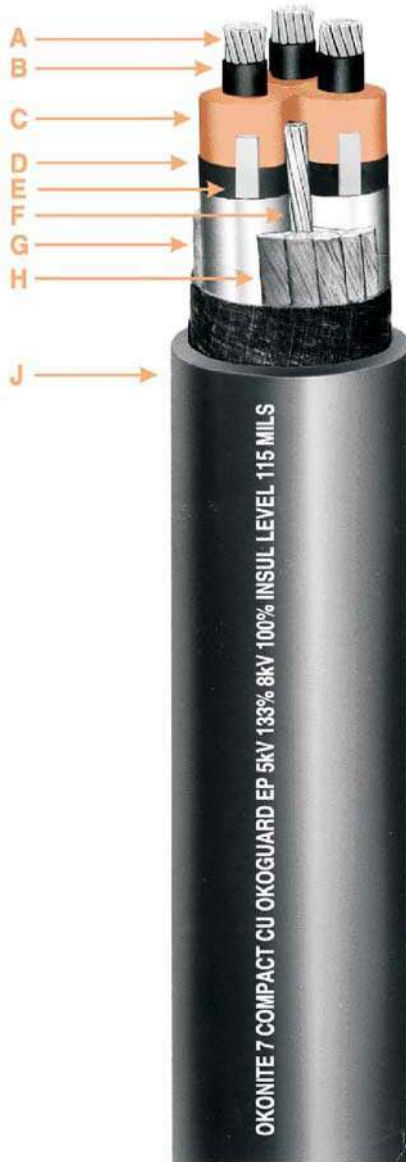

- A Uncoated Okopact (Compact Stranded) Copper Conductor
- B Extruded Semiconducting EPR Strand Screen
- C Okoguard Insulation (EPR)
- D Extruded Semiconducting EPR Insulation Screen
- E Phase Identification Tape
- F Okopact Compact Copper Grounding Conductor
- G Uncoated Copper Shield
- H Fillers and Binder Tape
- J Jacket-Black Okoseal

Insulation

Okoguard is Okonite's registered trade name for its exclusive ethylene-propylene rubber (EPR) base, thermosetting compound, whose optimum balance of electrical and physical properties is unequalled in other solid dielectrics. Okoguard insulation, with the distinctive red color and a totally integrated EPR system, provides the optimum balance of electrical and physical properties for long, problem free service.

Assembly

The Type MV-105 conductors are assembled with fillers and a binder tape overall. One bare stranded copper ground conductor is placed in one of the outer interstices.

Jacket

The Okoseal (PVC) jacket supplied with this cable is mechanically rugged and has excellent resistance to oil and most chemicals.

Applications

Okoguard shielded three conductor Type MV-105 power cables are recommended for distribution circuits, and for feeders or branch circuits in industrial & utility power distribution systems. Type MV cables may be installed in wet or dry locations, indoors or outdoors (exposed to sunlight), in any raceway or underground duct, directly buried, cable tray, or messenger supported in industrial establishments and electric utilities.

Specifications

Conductors: Uncoated copper compact stranded per ASTM B-496.

Strand Screen: Extruded semiconducting EPR strand screen meets or exceeds electrical and physical requirements of ICEA S-93-639/NEMA WC74, CSA C68.10 and UL 1072.

Insulation: Okoguard meets or exceeds the electrical and physical requirements of ICEA S-93-639/NEMA WC74, CSA C68.10 and UL 1072. The insulated conductors are tested in accordance with AEIC CS8.

Insulation Screen: Extruded semiconducting EPR insulation screen per ICEA S-93-639/NEMA WC74, AEIC CS8, CSA C68.10 and UL 1072.

Shield: 5 mil uncoated copper tape helically applied with 12.5% nominal overlap.

Phase Identification: Color coded (black, red, blue) polyester ribbon laid longitudinally under the copper shield.

Grounding Conductor: Uncoated copper compact stranded per ASTM B-496 and sized in accordance with UL 1072.

Assembly: Cabled with fillers and ground wire in the interstices, binder tape overall.

Jacket: Meets or exceeds electrical and physical requirements of ICEA S-93-639/NEMA WC74, CSA C68.10 and UL 1072 for polyvinyl chloride jackets.

UL Listed as Type MV-105, sunlight resistant for use in cable tray, and for direct burial in accordance with UL 1072.

Cables listed to CSA C68.10

Product Features

- Triple tandem extruded, all EPR system.
- Complete prepackaged, color coded, factory tested wiring system.
- Passes the UL 1072, IEEE 383 and IEEE 1202/FT4 Vertical Tray Flame Tests.
- Complies with NEC Section 336.36 and is suitable for direct buried when installed in accordance with NEC Sections 250.4(A)(5).
- Minimum installation temperature of -40°C.
- Excellent corona resistance.
- Screens and clean stripping.
- Exceptional resistance to "treeing".
- Improved Temperature Rating.
- Sizes 4/0 AWG and larger are CSA listed as FT4, SR, LTGG (-40°C), and TC-ER.
- Sizes smaller than 4/0 AWG are CSA listed as FT4, SR, LTDD (-25°C), and TC-ER.

Okoguard®-Okoseal® Type MV-105 5/8kV Okoguard Shielded Power Cable



Product Data Section 2: Sheet 19

3 Okopact® (Compact Stranded) Copper Conductor/105°C Rating
5kV-133% or 8kV-100% Insulation Level
For Cable Tray Use-Sunlight Resistant-For Direct Burial

Okoguard Insulation: 115 mils (2.92mm), 5kV-133% or 8kV-100% Insulation Level

Catalog Number (1)	Conductor size (AWG or kcmil)		Conductor Size -mm ²	Approx. Diameter over Insulation (in.)		Grounding Conductor Size (AWG/kcmil)		Grounding Conductor Size - mm ²		Approx. Core O.D. - Inches		Jacket Thickness - mils		Approx. O.D. - mm		Approx. O.D. - Inches		Approx. Net Weight lbs./1000'		Approx. Ship Weight lbs./1000'		Ampacities in Cable Tray (2)		Ampacities Direct Burial (3)	
▲ 114-23-3630 114-23-3633	6	13.3	0.44	6	13.3	1.10	27.9	80	2.03	1.29	32.8	1015	1115	88	115										
	4	21.2	0.48	6	13.3	1.19	30.2	80	2.03	1.38	35.1	1235	1390	115	150										
▲ 114-23-3640 114-23-3642	2	33.6	0.54	6	13.3	1.32	33.5	80	2.03	1.51	38.3	1560	1715	155	190										
	1/0	53.5	0.61	4	21.2	1.46	37.0	80	2.03	1.65	41.9	2090	2250	205	245										
▲ 114-23-3648 ▲ 114-23-3736 114-23-3770	2/0	67.4	0.65	4	21.2	1.55	39.4	110	2.79	1.80	45.7	2513	2695	240	280										
	4/0	107.0	0.75	3	26.7	1.77	45.0	110	2.79	2.02	51.3	3455	3780	320	360										
	250	127.0	0.80	2	26.7	1.88	47.8	110	2.79	2.13	54.1	3961	4245	355	395										
▲ 114-23-3772 ▲ 114-23-3782	350	177.0	0.89	2	33.6	2.08	52.8	110	2.79	2.33	59.2	5116	5665	440	475										
	500	253.0	1.01	1	42.4	2.33	59.2	110	2.79	2.59	65.8	6799	7430	545	570										
114-23-3811 114-23-3981	750	380.0	1.18	1/0	50.0	2.74	69.6	140	3.56	3.04	77.2	9749	11009	685	700										
	1000	506.7	1.34	2/0	70.0	3.09	78.5	140	3.56	3.38	85.9	12546	13976	790	785										

Okonite's web site, www.okonite.com contains the most up to date information.

For 8kV ampacities refer to the NEC tables referenced below in the columns listed 5001-35,000 Volts

▲ **Authorized stock item.** Available from our Customer Service Centers.

Aluminum Conductors

(1) Aluminum conductors are available on special order.

Ampacities

(2) Ampacities are in accordance with Table 315.60(C)(5) of the NEC for an insulated three conductor cable, isolated in air, with a conductor operating temperature of 105°C and an ambient air temperature of 40°C.

(3) Ampacities are in accordance with Table 315.60(C)(17) of the NEC for an insulated three conductor cable directly buried in the earth with a conductor operating temperature of 105°C, ambient earth temperature of 20°C, 100% load factor and thermal resistance (RHO) of 90.

Refer to the NEC, IEEE/ICEA S-135 Power Cable Ampacities, or the Okonite Engineering Data Bulletin for installation in duct banks, other ambient temperatures, circuit configurations or installation requirements.



Okoguard® Okoseal® Type MV-105 15kV Okoguard Shielded Power Cable



3 Okopact® (Compact Stranded) Copper Conductors/105°C Rating
100% & 133% Insulation Level
For Cable Tray Use-Sunlight Resistant-For Direct Burial



- A Uncoated Okopact (Compact Stranded) Copper Conductors
- B Extruded Semiconducting EPR Strand Screen
- C Okoguard Insulation (EPR)
- D Extruded Semiconducting EPR Insulation Screen
- E Phase Identification Tape
- F Okopact Copper Grounding Conductor
- G Uncoated Copper Shield
- H Fillers and Binder Tape
- J Jacket-Black Okoseal

Insulation

Okoguard is Okonite's registered trade name for its exclusive ethylene-propylene rubber (EPR) base, thermosetting compound, whose optimum balance of electrical and physical properties is unequalled in other solid dielectrics. Okoguard insulation, with the distinctive red color and a totally integrated EPR system, provides the optimum balance of electrical and physical properties for long, problem free service.

Assembly

The Type MV-105 conductors are assembled with fillers and a binder tape overall. One bare stranded copper ground conductor is placed in one of the outer interstices.

Jacket

The Okoseal (PVC) jacket supplied with this cable is mechanically rugged and has excellent resistance to oil and most chemicals.

Applications

Okoguard shielded three conductor Okoseal Type MV-105 power cables are recommended for distribution circuits, and for feeders or branch circuits in industrial and utility power distribution systems. Type MV cables may be installed in wet or dry locations, indoors or outdoors (exposed to sunlight), in any raceway or underground duct, directly buried, cable tray, or messenger supported in industrial establishments and electric utilities.

Specifications

Conductors: Uncoated copper compact stranded per ASTM B-496.

Strand Screen: Extruded semiconducting EPR strand screen meets or exceeds electrical and physical requirements of ICEA S-93-639/NEMA WC74, CSA C68.10 and UL 1072.

Insulation: Okoguard meets or exceeds the electrical and physical requirements of ICEA S-93-639/NEMA WC74, CSA C68.10 and UL 1072. The insulated conductors are tested in accordance with AEIC CS8.

Insulation Screen: Extruded semiconducting EPR insulation screen per ICEA S-93-639/NEMA WC74, AEIC CS8, CSA C68.10 and UL 1072.

Shield: 5 mil uncoated copper tape helically applied with 12.5% nominal overlap.

Phase Identification: Color coded (black, red, blue) polyester ribbon laid longitudinally under the copper tape shield.

Grounding Conductor: Uncoated copper compact stranded per ASTM B-496 and sized in accordance with UL 1072.

Assembly: Cabled with fillers and ground wire in the interstices, binder tape overall.

Jacket: Meets or exceeds electrical and physical requirements of ICEA S-93-639/NEMA WC74, CSA C68.10 and UL 1072 for polyvinyl chloride jackets.

UL Listed as Type MV-105, sunlight resistant for use in cable tray, and for direct burial in accordance with UL 1072.

Cables listed to CSA C68.10

Product Features

- Triple tandem extruded, all EPR system.
- Complete prepackaged, color coded, factory tested wiring system.
- Passes the UL 1072, IEEE 383 and IEEE 1202/FT4 Vertical Tray Flame Tests.
- Complies with NEC Section 336.6 and is suitable for direct buried when installed in accordance with NEC Sections 250.4(A)(5).
- Minimum installation temperature of -40°C.
- Excellent corona resistance.
- Screens are clean stripping.
- Exceptional resistance to "treeing".
- Improved Temperature Rating.
- Sizes 4/0 AWG and larger are CSA listed as FT4, SR, LTGG (-40°C), and TC-ER.
- Sizes smaller than 4/0 AWG are CSA listed as FT4, SR, LTDD (-25°C), and TC-ER.

Okoguard Okoseal Type MV-105 15kV Okoguard Shielded Power Cable



Product Data Section 2: Sheet 20

3 Okopact® (Compact Stranded) Copper Conductors/105°C Rating
100% & 133% Insulation Level
For Cable Tray Use-Sunlight Resistant-For Direct Burial

Catalog Number (1)	Conductor size AWG or kcmil		Conductor Size -mm ²	Approx. Dia. over Insulation (in.)		Grounding Conductor Sizes -Awg/kcmil		Approx. Conductor		Approx. Core O.D. - Inches		Jacket Thickness - mils		Approx. O.D. - Inches		Approx. Net Weight lbs./1000'		Approx. Ship Weight lbs./1000'		Ampacities in Cable Tray (2) Direct Burial (3)	
Okoguard Insulation: 175 mils (4.45mm), 100% Insulation Level																					
115-23-3766	2	33.6	0.67	6	13.3	1.59	40.4	110	2.79	1.83	46.5	1985	2130	185	200						
115-23-3768	1/0	53.5	0.74	4	21.2	1.74	44.2	110	2.79	1.97	50.0	2560	2770	240	255						
115-23-3770	2/0	67.4	0.78	4	21.2	1.82	42.2	110	2.79	2.06	52.3	2890	3150	275	290						
115-23-3772	4/0	107.0	0.88	3	26.7	2.04	51.8	110	2.79	2.28	57.9	3905	4190	360	375						
115-23-3774	250	127.0	0.93	3	26.7	2.15	54.6	110	2.79	2.39	60.7	4390	4930	400	410						
115-23-3776	350	177.0	1.03	2	33.6	2.36	59.9	110	2.79	2.59	65.8	5608	6210	490	495						
115-23-3778	500	253.0	1.14	1	42.4	2.61	66.3	140	3.56	2.91	73.9	7480	8255	600	590						
115-23-3780	750	380.0	1.32	1/0	53.5	2.99	75.9	140	3.56	3.29	83.6	10320	11330	745	720						
Okoguard Insulation: 220 mils (5.59mm), 133% Insulation Level																					
▲ 115-23-3802	2	33.6	0.76	6	13.3	1.79	45.5	110	2.79	2.02	51.3	2280	2575	185	200						
115-23-3804	1/0	53.5	0.83	4	21.2	1.93	49.0	110	2.79	2.17	55.1	2857	3145	240	255						
▲ 115-23-3806	2/0	67.4	0.87	4	21.2	2.02	51.3	110	2.79	2.26	57.4	3260	3570	275	290						
▲ 115-23-3808	4/0	107.0	0.97	3	26.7	2.24	56.9	110	2.79	2.48	63.0	4285	4640	360	375						
115-23-3810	250	127.0	1.03	3	26.7	2.36	60.0	110	2.79	2.59	65.8	4795	5295	400	410						
▲ 115-23-3812	350	177.0	1.12	2	33.6	2.56	65.0	140	3.56	2.85	72.4	6168	7000	490	495						
▲ 115-23-3814	500	253.0	1.24	1	42.4	2.81	71.4	140	3.56	3.10	78.7	7895	8945	600	590						
115-23-3816	750	380.0	1.41	1/0	53.5	3.19	81.0	140	3.56	3.49	88.7	10805	11800	745	720						

Okonite's web site, www.okonite.com contains the most up to date information.

▲ Authorized stock item. Available from our Customer Service Centers.

Aluminum Conductors

(1) Aluminum conductors available on special orders.

Ampacities

(2) Ampacities are in accordance with Table 315.60(C)(5) of the NEC for an insulated three conductor cable, isolated in air, with a conductor operating temperature of 105°C and an ambient air temperature of 40°C.

(3) Ampacities are in accordance with Table 315.60(C)(17) of the NEC for an insulated three conductor cable directly buried in the earth with a conductor operating temperature of 105°C, ambient earth temperature of 20°C, 100% load factor, thermal resistance (RHO) of 90.

Refer to the NEC, IEEE/CEA S-135 Power Cable Ampacities or the Okonite Engineering Data Bulletin for installation in duct banks, other ambient temperatures, circuit configurations or installation requirements.



C-L-X[®] VFD Type MV-90 or MC-HL

2.4kV Okoguard[®] Nonshielded Power Cable-Aluminum Sheath
5000V CSA RA90

3 Okopact[®] (Compact Stranded) Copper Conductors/90°C Rating
100% & 133% Insulation Level

For Cable Tray Use-Sunlight Resistant-For Direct Burial

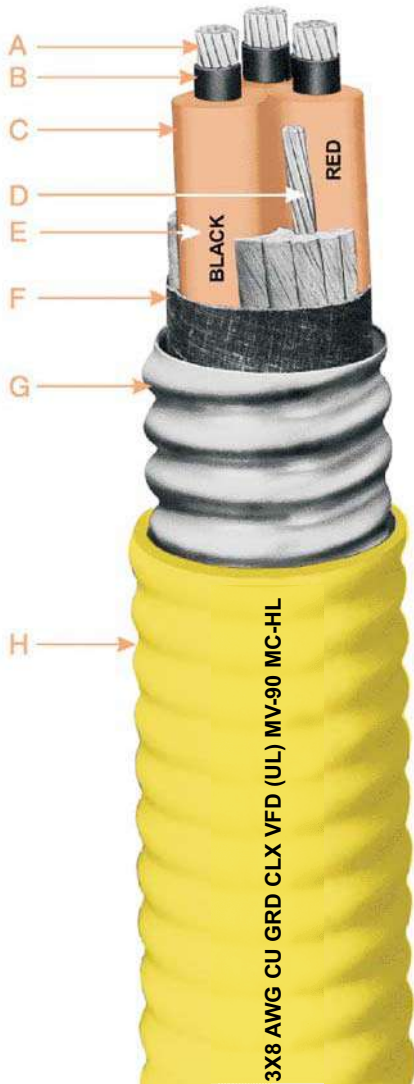

- A Uncoated Okopact (Compact Stranded) Copper Conductor
- B Extruded Semiconducting EPR Strand Screen
- C Okoguard (EPR) Insulation
- D Three Copper Grounding Conductors
- E Phase Identification
- F Fillers and Binder Tape
- G Impervious, Continuous, Corrugated Aluminum C-L-X Sheath
- H Jacket-Low Temperature Yellow Okoseal

Insulation

Okoguard is Okonite's registered trade name for its exclusive ethylene-propylene rubber (EPR) base, thermosetting compound, whose optimum balance of electrical and physical properties is unequalled in other solid dielectrics. Okoguard insulation, with the distinctive red color and a totally integrated EPR system, provides the optimum balance of electrical and physical properties for long, problem free service.

Assembly

The Type MV-90 conductors are assembled with fillers and a binder tape into a round core. Three bare stranded copper grounding conductors, located in the outer interstices, is provided for grounding. A continuously corrugated welded aluminum sheath C-L-X encases the cable core. The C-L-X sheath is protected with a low temperature yellow Okoseal[®] (PVC) jacket. The impervious, continuous, corrugated aluminum C-L-X sheath provides complete protection against moisture, liquids and gases in addition to its excellent mechanical strength. In addition, the aluminum CLX sheath exceeds the equipment grounding requirements of NEC Section 250.118 and 250.122, and can be used as the equipment grounding conductor in non-HL areas. The overall Okoseal (PVC) jacket allows the cable to be direct buried in the ground, embedded in concrete or areas subjected to a corrosive atmosphere.

Applications

C-L-X power cables are recommended as an economical alternate to a wire in conduit system. They are designed specifically for use on feeders and branch circuits in industrial power distribution systems. C-L-X power cables may be installed in both exposed and concealed work, wet and dry locations, direct burial in the earth, or embedded in concrete. They may be installed on metal racks, troughs, in cable trays or secured to supports not greater than 6 feet apart. C-L-X power cables are also approved for Classes I, II and III. Divisions 1 and 2 and Class I, Zones 1 and 2 hazardous locations - NEC Articles 501, 502, 503 and 505.

Medium voltage Non-Shielded cables discharge normally in service when spacing between phases is non-uniform or when phases are in close proximity to a grounded surface.

Specifications

Conductors: Annealed uncoated copper compact stranded per ASTM B-496.

Strand Screen: Extruded semiconducting EPR strand screen meets or exceeds electrical and

physical requirements of ICEA S-96-659/NEMA WC71 and UL 1072.

Insulation: Okoguard meets or exceeds the electrical and physical requirements of ICEA S-96-659/NEMA WC71 and UL 1072. Phase Identification: Print color code (black, red and blue).

Grounding Conductors: Three uncoated copper Class B in accordance with UL 1072.

Assembly: Cabled with fillers and ground wires, in the interstices, binder tape overall. Sheath: Close fitting, impervious, continuous, corrugated aluminum C-L-X per UL 1072. C-L-X is recognized as a grounding conductor by NEC.

Jacket: A low temperature sunlight resistant, yellow PVC jacket in accordance with UL 1072. Other color jackets are available.

UL Listed as type MV-90 or MC-HL, sunlight resistant, for use in cable tray, and for direct burial in accordance with UL 1072 and 2225.

Product Features

- Tandem extruded, all EPR system.
- Complete prepackaged, color coded, factory tested wiring system.
- Okoguard C-L-X cables meet or exceed electrical and physical requirements of all recognized industry standards (UL, AEIC, NEMA/ICEA, IEEE).
- Passes the vertical tray flame test requirements of IEEE 383 and 1202, UL 1072, ICEA T-29-520(210,000 BTU/hr.)
- Complies with NEC Section 336.36 and is suitable for direct buried when installed in accordance with NEC Sections 250.4(A)(5).
- Complies with NEC Articles 501, 502, 503 and 505 for hazardous locations.
- Continuous sheath provides grounding safety.
- Excellent corona resistance.
- Exceptional resistance to "treeing."
- Stress cones not required.
- Minimum installation temperature of -40°C.
- Three symmetrical grounding conductors with the CLX sheath provide a superior low resistance return path for VFD and other modern ac drive/motor applications.
- ABS listed as CWC MC Type MC-HL.
- CSA listed as RA90, FT4, SR, HL, -40°C and 5000V.

C-L-X VFD Type MV-90 or MC-HL
2.4kV Okoguard Nonshielded Power Cable-Aluminum Sheath
5000V CSA RA90
 3 Okopact® (Compact Stranded) Copper Conductors/90°C Rating
 100% & 133% Insulation Level
For Cable Tray Use-Sunlight Resistant-For Direct Burial



Product Data
Section 2: Sheet 21

Okoguard Insulation: 90 mils (2.29mm)

Catalog Number (1)	Conductor size (AWG or kcmil)		Conductor Size -mm ²	Approx. Diameter over Insulation (in.)	Grounding Conductors No. x Size (AWG/kcmil)		Approx. Core O.D. - Inches	C-L-X O.D. - mm		Jacket Thickness mils	Jacket Thickness mm	Approx. O.D. - Inches	Approx. O.D. - mm	Approx. Net Weight lbs./1000'	Approx. Ship Weight lbs./1000'	Ampacities in Cable Tray (2)	Ampacities Direct Burial (3)
With Yellow Okoseal Jacket																	
571-21-3193	8	8.4	0.36	3x12	0.77	19.6	0.97	50	1.27	1.08	27.4	565	630	59	85		
571-21-3196	6	13.3	0.39	3x10	0.85	21.6	1.06	50	1.27	1.17	29.7	740	820	79	105		
▲ 571-21-3200	4	21.2	0.44	3x10	0.97	24.6	1.19	50	1.27	1.30	33.0	960	1050	105	135		
▲ 571-21-3204	2	33.6	0.50	3x10	1.10	27.9	1.34	50	1.27	1.45	36.8	1270	1470	140	180		
571-21-3208	1	42.4	0.52	3x8	1.16	29.4	1.42	50	1.27	1.53	38.9	1520	1660	160	200		
571-21-3212	1/0	53.5	0.56	3x8	1.23	31.2	1.51	60	1.52	1.65	41.9	1835	1980	185	230		
▲ 571-21-3217	2/0	67.4	0.60	3x8	1.33	33.8	1.60	60	1.52	1.73	43.9	2160	2325	215	260		
▲ 571-21-3224	4/0	107.0	0.70	3x7	1.53	38.9	1.83	60	1.52	1.96	49.8	3075	3340	285	335		
571-21-3228	250	127.0	0.75	3x6	1.64	41.7	1.96	60	1.52	2.09	53.1	3470	3725	320	365		
▲ 571-21-3236	350	177.0	0.85	3x6	1.86	47.2	2.19	60	1.52	2.32	58.9	4705	5265	395	440		
▲ 571-21-3244	500	253.0	0.96	3x5	2.10	53.3	2.45	75	1.91	2.61	66.3	6405	6965	485	530		
571-21-3248	750	380.0	1.14	3x4	2.51	63.8	2.93	75	1.91	3.10	78.7	9220	980	615	650		
571-21-3252	1000	507.0	1.29	3x4	2.90	73.7	3.41	85	2.16	3.59	91.2	12075	13155	705	730		

Okonite's web site, www.okonite.com contains the most up to date information.

▲ **Authorized stock item.** Available from our Customer Service Centers.
Copper or bronze and non-jacketed C-L-X is available on special order.

Jackets
 Optional jacket types available - consult local sales office.

Aluminum Conductors
 (1) Aluminum conductors are available on special order.

Ampacities
 (2) Ampacities are in accordance with Table 315.60(C)(5) of the NEC for an insulated three conductor cable, isolated in air, with a conductor operating temperature of 90°C and an ambient air temperature of 40°C.

(3) Ampacities are in accordance with Table 315.60(C)(17) of the NEC for an insulated three conductor cable directly buried in the earth with a conductor operating temperature of 90°C, ambient earth temperature of 20°C, 100% load factor and thermal resistance (RHO) of 90.

Refer to the NEC, IEEE/ICEA S-135 Power Cable Ampacity Tables, or the Okonite Engineering Data Bulletin for installation in duct banks, other ambient temperatures, circuit configurations or installation requirements.

C-L-X® The Okonite Company



C-L-X[®] VFD Type MV-105 or MC-HL



5/8kV Okoguard[®] Shielded Power Cable-Aluminum Sheath
5000V CSA RA90

3 Okopact (Compact Stranded) Copper Conductors/105°C Rating
5kV - 133% or 8kV - 100% Insulation Level

For Cable Tray Use-Sunlight Resistant-For Direct Burial

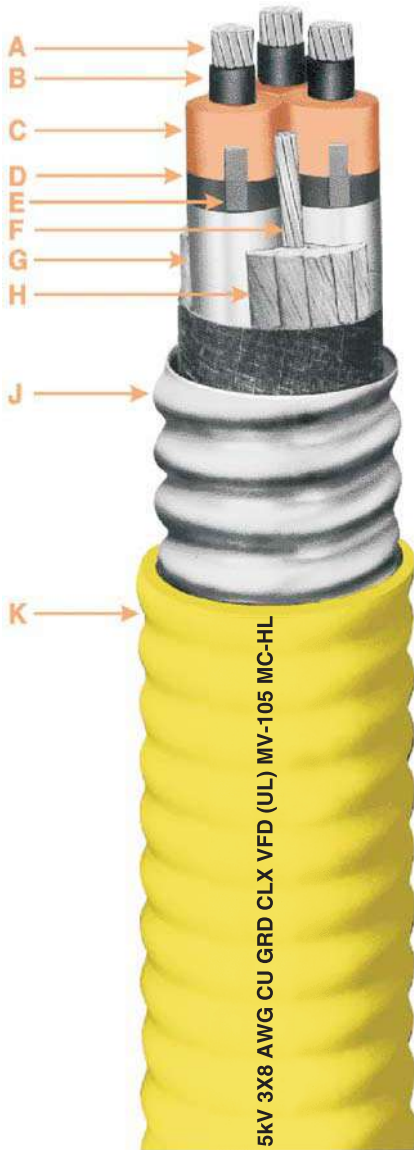

- A Uncoated (Compact Stranded) Copper Conductors
- B Extruded Semiconducting EPR Strand Screen
- C Okoguard Insulation (EPR)
- D Extruded Semiconducting EPR Insulation Screen
- E Phase Identification Tape
- F Three Copper Grounding Conductors
- G Uncoated Copper Shield
- H Fillers and Binder Tape
- J Impervious, continuous, Corrugated Aluminum C-L-X Sheath
- K Jacket-Yellow Okoseal

Insulation

Okoguard is Okonite's registered trade name for its exclusive ethylene-propylene rubber (EPR) base, thermosetting compound, whose optimum balance of electrical and physical properties is unequaled in other solid dielectrics. Okoguard insulation, with the distinctive red color and a totally integrated EPR system, provides the optimum balance of electrical and physical properties for long, problem free service.

Assembly

Type MV-105 conductors are assembled with fillers, three bare stranded grounding conductors and a binder tape into a round core. A continuously corrugated welded aluminum sheath (C-L-X) encases the cable core. The C-L-X sheath is protected with a low temperature yellow Okoseal[®] jacket. The impervious, continuous, corrugated aluminum C-L-X sheath provides complete protection against moisture, liquids and gases in addition to its excellent mechanical strength. In addition, the aluminum CLX sheath exceeds the equipment grounding requirements of NEC Section 250.118 and 250.122, and can be used as the equipment grounding conductor in non-HL areas. The Okoseal jacket allows the cable to be direct buried in the ground, embedded in concrete or areas subjected to corrosive atmospheres.

Applications

C-L-X power cables are recommended as an economical alternate to a wire in conduit system. They are designed specifically for use as feeders or branch circuits in industrial and utility power distribution systems. C-L-X power cables may be installed in both exposed and concealed work, wet and dry locations, directly buried in the earth, or embedded in concrete. They may be installed on metal racks, troughs, in cable trays or secured to supports not greater than 6 feet apart. C-L-X Type MC-HL cables are also approved for Classes I, II, and III, Division 1 and 2 and Class I, Zones 1 and 2 hazardous locations - NEC Articles 501, 502, 503 and 505.

Specifications

Conductors: Uncoated copper compact stranded per ASTM B-496.

Strand Screen: Extruded semiconducting EPR strand screen meets or exceeds electrical and physical requirements of ICEA S-93-639/NEMA WC74 and UL 1072.

Insulation: Okoguard meets or exceeds the electrical and physical requirements of ICEA S-93-639/NEMA WC74 and UL 1072. The insul-

ated conductors are tested in accordance with AEIC CS8.

Insulation Screen: Extruded semiconducting EPR insulation screen per ICEA S-93-639/NEMA WC74, AEIC CS8 and UL 1072.

Shield: 5 mil uncoated copper tape helically applied with 12.5% nominal overlap.

Phase Identification: Color coded (black, red, blue) polyester ribbon laid longitudinally under the copper shield tape.

Grounding Conductors: Three uncoated copper in accordance with UL 1072.

Assembly: Cabled with fillers and ground wires in the interstices, binder tape overall.

Sheath: Close fitting, impervious, continuous, corrugated aluminum C-L-X per UL 1072; C-L-X is recognized as a grounding conductor by NEC.

Jacket: A low temperature, sunlight resistant, yellow PVC jacket in accordance with UL 1072. Other color jackets are available. UL Listed as type MV-105 or MC-HL, sunlight resistant for use in cable tray, and for direct burial in accordance with UL 1072 & 2225. CSA Listed to C68.10.

Product Features

- Triple tandem extruded, all EPR system.
- Complete prepackaged, color coded, factory tested wiring system.
- Okoguard C-L-X cables meet or exceed all recognized industry standards (UL, AEIC, NEMA/ICEA, IEEE).
- Passes the vertical tray flame test requirements of IEEE 383 and 1202, UL 1072, ICEA T-29-520 (210,000 BTU/hr.).
- Complies with NEC Section 336.36 and is suitable for direct buried when installed in accordance with NEC Sections 250.4(A)(5).
- Complies with NEC Articles 501, 502, 503 and 505 for hazardous locations.
- Continuous sheath provides grounding safety.
- Excellent corona resistance.
- Screens are clean stripping.
- Exceptional resistance to "treeing".
- Minimum installation temperature of -40°C.
- Improved Temperature Rating.
- Three symmetrical grounding conductors with the CLX sheath provide a superior low resistance return path for VFD and other modern ac drive/motor applications.
- ABS listed as CWCMC Type MC-HL.
- CSA listed as FT4, SR, HL and LTGG (-40°C).

C-L-X VFD Type MV-105 or MC-HL

5/8kV Okoguard Shielded Power Cable-Aluminum Sheath
 3 Okopact (Compact Stranded) Copper Conductors/105°C Rating
 100% & 133% Insulation Level
 For Cable Tray Use-Sunlight Resistant-For Direct Burial

Product Data Section 2: Sheet 22



Okoguard Insulation: 115 mils (2.92mm), 5kV-133% or 8kV-100% Insulation Level

Catalog Number (1)	Conductor size (AWG or kcmil)		Conductor Size -mm ²	Approx. Diameter over Insulation (in.)	Grounding Conductors No. x Size (AWG/kcmil)		Approx. Core O.D. - Inches	Approx. Core O.D. - mm	C-L-X O.D. - Inches	Jacket Thickness mils	Jacket Thickness mm	Approx. O.D. - Inches	Approx. O.D. - mm	Approx. Net Weight lbs./1000'	Approx. Ship Weight lbs./1000'	Ampacities in Cable Tray (2)	Ampacities Direct Burial (3)
With Yellow Okoseal Jacket																	
* 571-22-3694	8	8.4	0.40	3x12	1.04	26.4	1.29	50	1.27	1.40	35.6	907	1056	66	90		
571-22-3696	6	13.3	0.44	3x10	1.12	28.4	1.37	50	1.27	1.48	37.6	1090	1259	88	115		
▲ 571-22-3698	4	21.2	0.48	3x10	1.21	30.7	1.51	60	1.52	1.65	41.9	1398	1556	115	150		
▲ 571-22-3706	2	33.6	0.54	3x10	1.34	34.0	1.64	60	1.52	1.78	45.2	1732	1890	154	190		
571-22-3708	1	42.4	0.58	3x8	1.40	35.6	1.69	60	1.52	1.82	46.2	1992	2137	180	215		
571-22-3710	1/0	53.5	0.61	3x8	1.48	37.6	1.78	60	1.52	1.91	48.5	2273	3012	205	245		
▲ 571-22-3717	2/0	67.4	0.65	3x8	1.57	39.9	1.92	60	1.52	2.00	50.8	2616	4171	240	280		
▲ 571-22-3725	4/0	107.0	0.75	3x7	1.78	45.2	2.15	60	1.52	2.29	58.2	3613	3980	320	360		
571-22-3727	250	127.0	0.80	3x6	1.90	48.3	2.28	60	1.52	2.44	62.0	4175	4390	355	395		
▲ 571-22-3838	350	177.0	0.89	3x6	2.10	53.3	2.45	75	1.91	2.61	66.3	5328	5435	440	475		
▲ 571-22-3846	500	253.0	1.01	3x5	2.35	57.6	2.75	75	1.91	2.91	73.9	7095	7603	545	570		
571-22-3748	750	380.0	1.19	3x4	2.73	69.3	3.24	85	2.16	3.42	86.9	10134	11021	685	700		
571-22-3751	1000	507.0	1.34	3x3	3.11	79.1	3.67	85	2.16	3.85	97.8	13164	14794	790	785		

* This cable is only rated 5kV (133%), due to UL limitations, it cannot be rated 8kV.
 Okonite's web site, www.okonite.com contains the most up to date information.

For 8kV ampacities refer to the NEC tables referenced below in the columns listed 5001-35,000 Volts

▲ **Authorized stock item.** Available from our Customer Service Centers.
Copper or bronze C-L-X and non-jacketed C-L-X are available on special order.
Jackets
 Optional jacket types available - consult local sales office.
Aluminum Conductors
 (1) Aluminum conductors are available on special order.
Ampacities
 (2) Ampacities are in accordance with Table 315.60(C)(5) of the NEC for an insulated three conductor cable, isolated in air, with a conductor operating temperature of 105°C and an ambient air temperature of 40°C.

(3) Ampacities are in accordance with Table 315.60(C)(17) of the NEC for an insulated three conductor cable directly buried in the earth with a conductor operating temperature of 105°C, ambient earth temperature of 20°C, 100% load factor and thermal resistance (RHO) of 90.
 Refer to the NEC, IEEE/ICEA S-135 Power Cable Ampacity Tables, or the Okonite Engineering Data Bulletin for installation in duct banks, other ambient temperatures, circuit configurations or installation requirements.
 C-L-X® The Okonite Company



C-L-X[®] Type MV-105 or MC-HL



15kV Okoguard[®] Shielded Power Cable-Aluminum Sheath

3 Okopact[®] (Compact Stranded) Copper Conductors/105°C Rating
133% Insulation Level

For Cable Tray Use-Sunlight Resistant-For Direct Burial

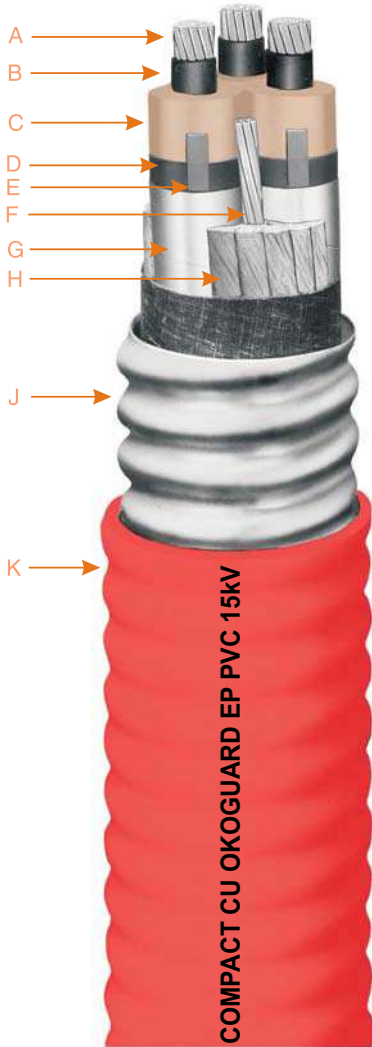

- A Uncoated Okopact (Compact Stranded) Copper Conductors
- B Extruded Semiconducting EPR Strand Screen
- C Okoguard Insulation (EPR)
- D Extruded Semiconducting EPR Insulation Screen
- E Phase Identification Tape
- F Copper Grounding Conductor
- G Uncoated Copper Shield
- H Fillers and Binder Tape
- J Impervious, Continuous, Corrugated Aluminum C-L-X Sheath
- K Jacket-Red Low Temperature Okoseal

Insulation

Okoguard is Okonite's registered trade name for its exclusive ethylene-propylene rubber (EPR) base, thermosetting compound, whose optimum balance of electrical and physical properties is unequalled in other solid dielectrics. Okoguard insulation, with the distinctive red color and a totally integrated EPR system, provides the optimum balance of electrical and physical properties for long, problem free service.

Assembly

The Type MV-105 conductors are assembled with fillers, one bare stranded grounding conductor and a binder tape into a round core. A continuously corrugated welded aluminum sheath (C-L-X) encases the cable core. The C-L-X sheath is protected with a low temperature red Okoseal[®] jacket. The impervious, continuous, corrugated aluminum C-L-X sheath provides complete protection against moisture, liquids and gases in addition to its excellent mechanical strength. In addition, the aluminum CLX sheath exceeds the equipment grounding requirements of NEC Section 250.118 and 250.122, and can be used as the equipment grounding conductor in non-HL areas. The Okoseal jacket allows the cable to be direct buried in the ground, embedded in concrete or areas subjected to corrosive atmospheres.

Applications

C-L-X power cables are recommended as an economical alternate to a wire in conduit system. They are designed specifically for use as feeders or branch circuits in industrial and utility power distribution systems. C-L-X power cables may be installed in both exposed and concealed work, wet and dry locations, direct burial in the earth, or embedded in concrete. They may be installed on metal racks, troughs, in cable trays or secured to supports not greater than 6 feet apart.

C-L-X Type MC-HL cables are also approved for Classes I, II, and III, Divisions 1 and 2 and Class I, Zones 1 and 2 hazardous locations - NEC Articles 501, 502, 503 and 505.

Specifications

Conductors: Uncoated copper compact stranded per ASTM B-496.

Strand Screen: Extruded semiconducting EPR strand screen meets or exceeds electrical and physical requirements of ICEA S-93-639/NEMA WC74 and UL 1072.

Insulation: Okoguard meets or exceeds the electrical and physical requirements of ICEA S-93-639/NEMA WC74 and UL 1072. The in-

ulated conductors are tested in accordance with AEIC CS8.

Insulation Screen: Extruded semiconducting EPR insulation screen meets or exceeds electrical and physical requirements of ICEA S-93-639/NEMA WC74 and UL 1072.

Shield: 5 mil uncoated copper tape helically applied with 12.5% nominal overlap.

Phase Identification: Color coded (black, red, blue) polyester ribbon laid longitudinally under the copper shield tape.

Grounding Conductor: Uncoated copper in accordance with UL 1072.

Assembly: Cabled with fillers and ground wire in the interstices, binder tape overall.

Sheath: Close fitting, impervious, continuous, corrugated aluminum C-L-X per UL 1072; C-L-X is recognized as a grounding conductor by NEC.

Jacket: A low temperature, sunlight resistant, red PVC jacket in accordance with UL 1072. Other color jackets are available. UL Listed as type MV-105 or MC-HL, sunlight resistant, for use in cable tray, and for direct burial in accordance with UL 1072 and 2225. UL certified to IEEE 1580. CSA Listed to C68.10.

Product Features

- Triple tandem extruded, all EPR system.
- Complete prepackaged, color coded, factory tested wiring system.
- Okoguard C-L-X cables meet or exceed all recognized industry standards (UL, AEIC, NEMA/ICEA, IEEE).
- Passes the vertical tray flame test requirements of IEEE 383 and 1202, UL 1072, ICEA T-29-520 (210,000 BTU/hr.)
- Complies with NEC Section 336.36 and is suitable for direct buried when installed in accordance with NEC Sections 250.4(A)(5).
- Complies with NEC Articles 501, 502, 503 and 505 for hazardous locations.
- Continuous sheath provides grounding safety.
- Excellent corona resistance.
- Screens are clean stripping.
- Exceptional resistance to "treeing".
- Minimum installation temperature of -40°C.
- Improved Temperature Rating.
- ABS listed as CWCMC Type MC-HL.
- CSA listed as FT4, SR, HL and LTGG (-40°C).

C-L-X Type MV-105 or MC-HL

15kV Okoguard Shielded Power Cable-Aluminum Sheath
 3 Okopact (Compact Stranded) Copper Conductors/105°C Rating
 133% Insulation Level
For Cable Tray Use-Sunlight Resistant-For Direct Burial
Okoguard Insulation: 220 mils (5.59mm)

Product Data Section 2: Sheet 24



Catalog Number (1)	Conductor size (AWG or kcmil)	Conductor Size -mm ²	Approx. Diameter over Insulation (in.)	Grounding Conductor Size (AWG/kcmil)	Approx. Core O.D. - Inches	C-L-X O.D. - mm	Jacket Thickness (mils)	Jacket Thickness mm	Approx. O.D. - Inches	Approx. O.D. - mm	Approx. Net Weight lbs./1000'	Approx. Ship Weight lbs./1000'	Ampacities in Cable Tray (2)	Ampacities Direct Burial (3)	
With Red Okoseal Jacket															
▲ 571-23-3504	2	33.6	0.76	6	1.79	45.5	2.15	60	1.52	2.28	57.9	2420	3147	185	200
571-23-3508	1	42.4	0.79	4	1.86	47.3	2.23	60	1.52	2.36	60.0	2706	3404	210	225
571-23-3512	1/0	53.5	0.83	4	1.94	49.3	2.32	75	1.91	2.48	63.0	3076	3674	240	255
▲ 571-23-3516	2/0	67.4	0.87	4	2.03	51.6	2.41	75	1.91	2.57	65.3	3434	4219	275	290
▲ 571-23-3524	4/0	107.0	0.97	3	2.24	57.0	2.63	75	1.91	2.79	70.9	4460	5385	360	375
571-23-3528	250	127.0	1.03	2	2.36	60.0	2.76	75	1.91	2.92	74.2	5078	5845	400	410
▲ 571-23-3536	350	177.0	1.12	2	2.56	65.0	2.98	75	1.91	3.14	79.8	6264	7305	490	495
▲ 571-23-3544	500	253.0	1.24	1	2.81	71.4	3.28	75	1.91	3.46	89.2	8221	9653	600	590
▲ 571-23-3548	750	380.0	1.41	1/0	3.19	81.0	3.76	85	2.16	3.94	100.0	11317	13087	745	720

Okonite's web site, www.okonite.com contains the most up to date information.

▲ **Authorized stock item.** Available from our Customer Service Centers.

Jackets

Optional jacket types available - consult local sales office.

Copper or bronze C-L-X and non-jacketed C-L-X are available on special order.

Aluminum Conductors

(1) Aluminum conductors are available on special order.

Ampacities

(2) Ampacities are in accordance with Table 315.60(C)(5) of the NEC for an insulated three conductor cable, isolated in air, with a conductor operating temperature of 105°C and an ambient air temperature of 40°C.

(3) Ampacities are in accordance with Table 315.60(C)(17) of the NEC for an insulated three conductor cable directly buried in the earth with a conductor operating temperature of 105°C, ambient earth temperature of 20°C, 100% load factor, thermal resistance (RHO) of 90.

Refer to the NEC, IEEE 835 Power Cable Ampacity Tables, or the Okonite Engineering Data Bulletin for installation in duct banks, other ambient temperatures, circuit configurations or installation requirements.

C-L-X® The Okonite Company



Solid Type PILC

15kV Paper Insulated Lead Covered Power Cable

Three Copper Conductors/90°C Rating
100% Insulation Level



- A Conductor-Stranded Compact Sector, Pre-twisted
- B Strand Screen-Carbon Black Paper Tapes
- C Insulation-Impregnated Paper Tapes
- D Insulation Screen-Carbon Black Paper Tape
- E Shield Copper Tape
- F Fillers-Impregnated Paper
- G Binder Copper Tape
- H Sheath-Copper Bearing Lead
- J Jacket

Conductor

Okonite's multiconductor PILC cables are available with three different style conductors depending on the application. The three conductor styles are compressed round, compact round and compact (120°) sector.

Insulation

Okonite's impregnated paper insulation consists of the finest electrical grade paper made from the highest quality coniferous wood pulp and the purest polybutene dielectric fluid. The paper is manufactured to meet Okonite specifications to produce the necessary mechanical and physical properties to resist tearing and wrinkling during manufacture and subsequent handling during field operations; and in addition to assure properties of low dielectric loss with high dielectric strength. To maintain a smooth, wrinkle-free precisely gapped tape insulation, Okonite carefully slits its own paper tapes into widths tailored for each conductor size and wall thickness. Most importantly, Okonite has the most precise tape tensions available. The impregnating fluid used is a medium viscosity polybutene type with an optional high viscosity fluid for warm installations, risers installations or installations with severe elevation changes. Polybutene fluids are superior in that they resist aging, have lower and more stable power factor values and possess an inherent tackiness which resists draining. Okonite treats the dielectric fluid with clay-filtering and then de-gases it prior to impregnating the cable to provide the lowest power factor and ionization levels.

Sheath & Jacket

Okonite's copper bearing lead sheath provides an impervious barrier from the environment; in addition, it provides mechanical protection for the insulation and encapsulation of the impregnant. All lead sheaths have the inherent capacity for substantial electrical conductivity, even under short circuit conditions without requiring a separate ground. Okonite's lead sheaths are applied with a continuous lead extruder under the control of a thickness gauge for uniform wall thickness and concentricity of extrusion.

The Okolene jacket provides mechanical and corrosion protection for the lead sheath and is used in most installations. (Indoor and aerial installations may not require a jacket). Okolene is a thermoplastic polyethylene material that resists most chemicals and moisture; it is unaffected by oils below 60°C and has a low coefficient of friction which aids pulling through ducts and conduits.

Applications

Okonite Paper Insulated Lead Covered 3/C cable is recommended for use in underground ducts, direct buried, and aerially when lashed to a messenger.

PILC cables are used in any circuit that requires the highest reliability, the longest uninterrupted service life, and where the greatest surge, impulse and AC dielectric strength is desired. An added advantage is that a 3/C PILC cable permits the largest amount of power to be transmitted in the smallest diameter space because of its unique triangle shaped and nested design. Although not shown as an insulation above 600 Volts in the National Electrical Code, it is readily approved for use by local inspectors because of its extensive safe use by utilities. Therefore, PILC cables can be used in industrial or commercial applications with prior notification and approval by the local inspector. Also available in other voltage ratings.

Specifications

Okonite PILC cables are available in accordance with AEIC CS1-90 or AEIC CS1-12.

- Cables made per AEIC CS1-90 have traditional nominal wall thicknesses for the lead sheath and overall jacket.
- Cables made per AEIC CS1-12 have "minimum point" wall thicknesses for the lead sheath and overall jacket.

Specifications

- Copper conductors available as:
 - Concentric Round
 - Compact Round
 - Compact Sector (Pre-twisted)
- 90°C continuous operation.
- 110°C emergency rating.
- 200°C short circuit rating.
- Polybutene impregnating fluid.
- Type H (shielded) cable.
- High impulse strength.
- Proven service life of over 80 years.
- Impervious to environment.
- Copper bearing lead sheath.

Options

- Available in other voltage ranges from 0.6 through 69 kV.
- Available with 133 and 173% insulation levels.
- Available as 3 and 4 conductor cables.
- Available with high viscosity dielectric fluid for risers and installations with severe elevation differences.
- Available with a reinforced lead sheath (ROC-Reinforced Okonite Covering).
- Available with LS/ZH Okoclear TP (TPPO) and Okoseal (PVC) jackets.
- Belted PILC cables are also available.

Solid Type PILC

15kV Paper Insulated Lead Covered Power Cable

Three Copper Conductor/90°C Rating
100% Insulation Level

Product Data

Section 2: Sheet 31

AEIC CS1-90 11th Edition(A)

Catalog Number	Conductor size AWG/kcmil	Conductor Size -mm ²	Insulation Thickness Nominal-mils	Lead Thickness Nominal-mils	Jacket Thickness Nominal-mils	Cable Diameter-inches	New Weight - lbs./ft.	Ampacities Duct (1) (100% LF)	Ampacities in Duct (2) (75% LF)
Concentric Round									
101-63-4120	2	33.6	180	90	90	1.92	4.34	146	154
101-63-4175	1	42.4	165	90	90	1.94	4.53	167	176
Compact Round									
101-63-4243	1/0	53.5	165	90	90	1.97	4.83	191	202
Compact Sector									
101-63-4277	2/0	67.4	165	90	90	1.92	4.80	215	228
101-63-4335	3/0	85.0	165	90	90	2.00	5.32	245	260
101-63-4373	4/0	107.0	165	90	90	2.12	6.13	280	297
101-63-4436	250	127.0	165	90	90	2.19	6.67	307	327
▲101-63-4544	350	177.0	165	90	90	2.37	8.19	371	397
▲101-63-4665	500	253.0	165	110	110	2.64	10.37	450	483
101-63-4904	750	380.0	165	110	110	2.94	13.71	555	599

A-Lead sheath and jacket thicknesses per AEIC CS1-90 version using traditional nominal thicknesses.

AEIC CS1-12 12th Edition(B)

Catalog Number	Conductor size AWG/kcmil	Conductor Size -mm ²	Insulation Thickness Nominal-mils	Lead Thickness Nominal-mils	Jacket Thickness Nominal-mils	Cable Diameter-inches	New Weight - lbs./ft.	Ampacities Duct (1) (100% LF)	Ampacities in Duct (2) (75% LF)
Concentric Round									
101-61-4120	2	33.6	180	85	70	1.93	4.46	146	154
101-61-4175	1	42.4	165	85	70	1.95	4.65	167	176
Compact Round									
101-61-4243	1/0	53.5	165	85	70	1.98	4.96	191	202
Compact Sector									
101-61-4277	2/0	67.4	165	85	70	1.93	4.92	215	228
101-61-4335	3/0	85.0	165	85	70	2.02	5.45	245	260
101-61-4373	4/0	107.0	165	85	70	2.12	6.11	280	297
101-61-4436	250	127.0	165	85	70	2.20	6.65	307	327
101-61-4544	350	177.0	165	85	70	2.37	8.00	371	397
101-61-4665	500	253.0	165	100	85	2.65	10.61	450	483
101-61-4904	750	380.0	165	100	85	2.95	13.73	555	599
101-61-4986	1000	507.0	165	100	100	3.29	16.95	636	689

Authorized Stock Item. Stock items use high viscosity polybutene impregnating fluid. Available from our Customer Service Centers.

(1) Ampacity for one circuit, one conduit in ductbank, 90°C conductor temperature, 90 RHO soil 20°C earth temperature, 100% Load Factor, multi point grounded sheaths. Per Okonite Bulletin 205, page 53.

(2) Ampacity for one circuit, one conduit in ductbank, 90°C conductor temperature, 90 RHO soil 20°C earth temperature, 75% Load Factor, multi point grounded sheaths. Per Okonite Bulletin 205, page 53.

B- Lead sheath and jacket thicknesses per AEIC CS1-12 version using minimum point thicknesses.



Okoguard® URO-J

15kV Underground Primary Distribution Cable-Jacketed Red Identification Stripes

Aluminum Conductor/105°C Rating
100% and 133% Insulation Levels



- A Conductor-Stranded Aluminum
- B Strand Screen-
Extruded Semiconducting EPR
- C Insulation-Okoguard-EPR
- D Insulation Screen-
Extruded Semiconducting EPR
- E Concentric Conductor-Bare
Copper Wires
- F Encapsulating Jacket-Okolene
with 3 extruded red ID stripes
and NESC lightning bolt

Insulation

Okoguard is Okonite's registered trade name for its exclusive ethylene-propylene rubber (EPR) based, thermosetting compound, whose optimum balance of electrical and physical properties is unequaled in other solid dielectrics. Okoguard insulation, with the distinctive red color and a totally integrated EPR system, provides the optimum balance of electrical and physical properties for long, problem free service.

The triple tandem extrusion of the screens with the insulation provides optimum electrical characteristics.

An insulation screen of ethylene-propylene rubber is extruded over the insulation. The bare copper concentric wires are uniformly spaced around the insulation screen. The overall polyethylene jacket provides protection against mechanical damage and corrosion.

Product identification is provided through the use of three red stripes placed 120° apart in the black jacket with an NESC lightning bolt.

Applications

Okoguard URO-J cables provide maximum circuit longevity in underground residential distribution systems. They can be buried directly or installed in underground ducts or conduits.

Specifications

Central Conductor: Aluminum per ASTM B-609, Class B stranded per B-231.

Conductor Screen: Extruded semiconducting ethylene-propylene rubber meets or exceeds the requirements of ICEA S-94-649, AEIC CS8, and CSA C68.5.

Insulation: Extruded Okoguard meets or exceeds the requirements of ICEA S-94-649, AEIC CS8, and CSA C68.5.

Insulation Screen: Extruded semiconducting ethylene-propylene rubber meets or exceeds the requirements of ICEA S-94-649, AEIC CS8, and C68.5.

Concentric Conductor: Bare copper wires.

Jacket: Black Okolene with red extruded stripes meets or exceeds the requirements of ICEA S-94-649, AEIC CS8, and CSA C68.5 for polyethylene jackets.

Product Features

- Triple tandem extruded, all EPR system
 - Okoguard cables meet or exceed ICEA standards.
 - Meets RUS 1728.204 for cables with filled strand or solid conductor and 133% insulation level.
 - 105°C continuous operating temperature.
 - 140°C emergency rating.
 - 250°C short circuit rating.
 - Excellent corona resistance.
 - Low dielectric constant and power factor.
 - Screens are clean stripping.
 - Exceptional resistance to "treeing".
 - Moisture resistant.
 - Overall jacket provides extended life.
 - Red extruded stripes.
 - Excellent resistance to most chemicals.
 - Can be listed by UL as Type MV-90 on Special Orders.
 - CSA C68.5 listed, LTGG (-40°C), SR.
 - Design Options:
 - Additional conductor sizes
 - Filled strand
 - Copper central conductor
 - Copper flat strap concentric neutral
 - Product identification via colored jackets.
 - Semiconducting jacket
 - Improved Temperature Rating.
- Okoguard insulation system has been tested and qualified for operation at 105°C continuous and 140°C emergency operating temperature.
- Minimum installation temperature of -40°C.

Okoguard URO-J

15kV Underground Primary Distribution Cable-Jacketed

Red Identification Stripes
Aluminum Conductor/105°C Rating
100% Insulation Level

Product Data

Section 2: Sheet 35



Okoguard Insulation: 175 mils 100% Insulation Level

Catalog Number	Conductor size (AWG or kcmil)	Nominal Dia. over Insulation (in.)	Insulation Screen Thickness (mils)	Nominal Dia. over Insulation Screen (in.)	Copper Neutral, No. x AWG (1)	Nominal O.D. (in.)	Approx. Net Weight lbs./1000'	Approx. Ship Weight lbs./1000'	90°C Ampacity Direct Burial (2)	90°C Ampacity Duct (2)	105°C Ampacity Direct Burial (2)	105°C Ampacity Duct (2)
FULL NEUTRAL												
161-23-2057	2(1X)	0.66	30	0.73	10X14	0.97	499	603	170	125	185	135
161-23-2060	2(7X)	0.67	30	0.75	10X14	0.98	512	568	170	125	185	135
161-23-2066	1(19X)	0.72	30	0.79	13X14	1.03	587	698	195	145	210	155
161-23-2069	1/0(1X)	0.72	30	0.80	16X14	1.03	642	747	220	160	235	175
161-23-2072	1/0(19X)	0.75	30	0.83	16X14	1.06	662	725	220	160	235	175
161-23-2075	2/0(19X)	0.80	30	0.87	14X12	1.14	791	910	250	185	270	205
161-23-2078	3/0(19X)	0.85	30	0.92	16X12	1.19	908	1029	285	210	310	230
161-23-2081	4/0(19X)	0.90	30	0.98	14X10	1.29	1129	1238	320	240	350	260
161-23-2084	250(37X)	0.97	30	1.04	16X10	1.36	1268	1418	350	270	380	295
161-23-2090	350(37X)	1.07	40	1.17	18X.1078	1.50	1598	1793	425	310	460	340
1/3 NEUTRAL												
160-23-2057	2(1X)	0.66	30	0.73	6X14	0.97	452	528	150	120	165	135
160-23-2060	2(7X)	0.67	30	0.75	6X14	0.98	465	579	150	120	165	135
160-23-2066	1(19X)	0.72	30	0.79	6X14	1.03	505	617	175	140	185	150
160-23-2069	1/0(1X)	0.72	30	0.80	6X14	1.03	525	663	195	155	215	170
160-23-2072	1/0(19X)	0.74	30	0.83	6X14	1.06	545	662	195	155	215	170
160-23-2075	2/0(19X)	0.80	30	0.87	7X14	1.11	611	726	225	180	240	195
160-23-2078	3/0(19X)	0.85	30	0.92	9X14	1.16	695	889	255	200	275	220
160-23-2081	4/0(19X)	0.90	30	0.98	11X14	1.21	792	922	285	235	310	255
160-23-2084	250(37X)	0.97	30	1.04	13X14	1.28	892	1018	305	250	330	275
160-23-2090	350(37X)	1.07	40	1.17	18X14	1.41	1135	1315	375	310	405	335
160-23-2093	500(37X)	1.20	40	1.30	16X12	1.57	1470	1691	450	370	490	405
160-23-2096	750(61X)	1.39	40	1.49	16X.0966	1.86	2062	2402	545	460	595	505
160-23-2099	1000(61X)	1.54	40	1.64	18X.1052	2.03	2580	2877	620	520	675	570

Okonite's web site, www.okonite.com contains the most up to date information.

(1) Individual wire size and count may vary. The resulting combination meets the 1/3 or full neutral, size requirement.

Ampacities

(2) Full neutral, single phase ampacities are based on ICEA P-117-734 for 90°C or 105°C conductor temperature, 25°C ambient temperature, 100% load factor, and earth thermal resistivity of RHO 90. One third neutral ampacities are based on triplexed or triangular configuration for the same conditions stated above.

Okoguard URO-J

15kV Underground Primary Distribution Cable-Jacketed

Red Identification Stripes
Aluminum Conductor/105°C Rating
133% Insulation Levels

Product Data

Section 2: Sheet 35



Okoguard Insulation: 220 mils 133% Insulation Level

Catalog Number	Conductor size (AWG or kcmil)	Nominal Dia. over Insulation (in.)	Insulation Screen Thickness (mils)	Nominal Dia. over Insulation Screen (in.)	Copper Neutral, No. x AWG (1)	Nominal O.D. (in.)	Approx. Net Weight lbs./1000'	Approx. Ship Weight lbs./1000'	90°C Ampacity Direct Burial (2)	105°C Ampacity Duct (2)	105°C Ampacity Direct Burial (2)	105°C Ampacity Duct (2)
FULL NEUTRAL												
▲ 161-23-3057	2(1X)	0.74	30	0.82	10X14	1.06	572	635	170	125	185	135
161-23-3060	2(7X)	0.77	30	0.84	10X14	1.08	590	662	170	125	185	135
161-23-3066	1(19X)	0.81	30	0.88	13X14	1.12	669	781	195	145	210	155
▲ 161-23-3069	1/0(1X)	0.80	30	0.89	16X14	1.12	721	792	220	160	235	175
▲ 161-23-9525	1/0(1X)	0.80	30	0.89	10X14*	1.12	651	718	230	170	245	185
161-23-3072	1/0(19X)	0.84	30	0.92	16X14	1.15	746	818	220	160	235	175
161-23-3075	2/0(19X)	0.89	30	0.92	14X12	1.23	900	1012	250	185	270	205
161-23-3078	3/0(19X)	0.94	30	1.01	16X12	1.28	998	1136	285	210	310	230
161-23-3081	4/0(19X)	0.98	30	1.06	14X10	1.38	1226	1357	320	240	350	260
161-23-3084	250(37X)	1.06	40	1.16	16X10	1.47	1405	1619	350	270	380	295
161-23-3090	350(37X)	1.16	40	1.26	18X.1078	1.59	1716	1912	425	310	460	340
1/3 NEUTRAL												
160-23-3057	2(1X)	0.74	30	0.82	6X14	1.06	525	621	150	120	165	135
160-23-3060	2(7X)	0.76	30	0.84	6X14	1.08	543	659	150	120	165	135
160-23-3066	1(19X)	0.81	30	0.88	6X14	1.12	586	700	175	140	185	150
160-23-3069	1/0(1X)	0.80	30	0.89	6X14	1.12	604	715	195	155	215	170
160-23-3072	1/0(19X)	0.84	30	0.92	6X14	1.15	629	748	195	155	215	170
160-23-3075	2/0(19X)	0.89	30	0.96	7X14	1.20	699	826	225	180	240	195
160-23-3078	3/0(19X)	0.94	30	1.01	9X14	1.25	787	916	255	200	275	220
160-23-3081	4/0(19X)	0.99	30	1.06	11X14	1.30	884	1002	285	235	310	255
160-23-3084	250(37X)	1.06	40	1.16	13X14	1.40	1024	1168	305	250	330	275
160-23-3090	350(37X)	1.16	40	1.26	18X14	1.50	1243	1458	375	310	405	335
160-23-3093	500(37X)	1.29	40	1.39	16X12	1.72	1650	1959	450	370	490	405
160-23-3096	750(61X)	1.47	40	1.58	16X.0966	1.95	2201	2518	545	460	595	505
160-23-3099	1000(61X)	1.64	55	1.77	18X.1052	2.16	2802	3223	620	520	675	570
▲ 160-23-9590	1100(61X)	1.61	55	1.74	18X12	2.01	2470	2833	675	575	730	620

Okonite's web site, www.okonite.com contains the most up to date information.

* - Special design 64% neutral

** - Special design 1/6 neutral, compact conductor, non-CSA listed, reduced jacket thickness not in compliance with AEIC/ICEA.

(1) Individual wire size and count may vary. The resulting combination meets the 1/3 or full neutral, size requirement.

▲ **Authorized stock item.** Available from our Customer Service Centers.

Ampacities

(2) Full neutral, single phase ampacities are based on ICEA P-117-734 for 90°C or 105°C conductor temperature, 25°C ambient temperature, 100% load factor, and earth thermal resistivity of RHO 90.

One third neutral ampacities are based on triplexed or triangular configuration for the same conditions stated above.

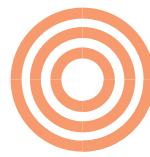

Okoguard[®] URO-J 15kV Underground Primary Distribution Cable-Jacketed Red Identification Stripes

Filled Strand Aluminum Conductor/105°C Rating
100% and 133% Insulation Levels



- A Conductor-Stranded Aluminum with Filled Strand
- B Strand Screen - Extruded Semiconducting EPR
- C Insulation-Okoguard EPR
- D Insulation Screen - Extruded Semiconducting EPR
- E Concentric Conductor-Bare Copper Wires
- F Encapsulating Jacket-Okolene with Extruded ID Stripes & NESC lightning bolt

Insulation

Okoguard is Okonite's registered trade name for its exclusive ethylene-propylene rubber (EPR) based, thermosetting compound, whose optimum balance of electrical and physical properties is unequalled in other solid dielectrics. Okoguard insulation, with the distinctive red color and a totally integrated EPR system, provides the optimum balance of electrical and physical properties for long, problem free service.

The triple tandem extrusion of the screens with the insulation provides optimum electrical characteristics.

The compressed conductors are filled with a water swellable agent. This construction slows the migration of water through the strands in the event of a mechanical dig-in followed by external exposure to water.

An insulation screen of ethylene-propylene rubber is extruded over the insulation. The copper concentric wires are uniformly spaced around the insulation screen. The overall polyethylene jacket provides protection against mechanical damage and corrosion.

Product identification is provided through the use of three red stripes placed 120° apart in the black jacket, with an NESC lightning bolt.

Applications

Okoguard URO-J cables provide maximum circuit longevity in underground residential distribution systems. They can be buried directly or installed in underground ducts or conduits.

Specifications

Central Conductor: Aluminum per ASTM B-609, Class B stranded per B-231.

Filled Strand: Water swellable agent meets or exceeds ICEA T-31-610 water penetration resistance and ANSI/NEMA class A connectorability requirements.

Conductor Screen: Extruded semiconducting ethylene-propylene rubber meets or exceeds the requirements of ICEA S-94-649, AEIC CS8, and CSA C68.5.

Insulation: Extruded Okoguard meets or exceeds the requirements of ICEA S-94-649, AEIC CS8, and C68.5.

Insulation Screen: Extruded semiconducting ethylene-propylene rubber meets or exceeds the requirements of ICEA S-94-649, AEIC CS8, and CSA C68.5.

Concentric Conductor: Bare copper wires.

Jacket: Black Okolene with red extruded stripes meets or exceeds the requirements of ICEA S-94-649, AEIC CS8, and CSA C68.5 for polyethylene jackets.

Product Features

- Triple tandem extruded, all EPR system.
 - Okoguard cables meet or exceed ICEA standards.
 - Meets RUS 1728.204 for cables with filled strand or solid conductor and 133% insulation level.
 - 105°C continuous operating temperature.
 - 140°C emergency rating.
 - 250°C short circuit rating.
 - Excellent corona resistance.
 - Low dielectric constant and power factor.
 - Screens are clean stripping.
 - Exceptional resistance to "treeing".
 - Filled strand conductor.
 - Moisture resistant.
 - Overall jacket provides extended life.
 - Excellent resistance to most chemicals.
 - Can be listed by UL as Type MV-90 on Special Orders.
 - CSA C68.5 listed, LTGG (-40°C), SR.
 - Design Options:
 - Additional conductor sizes
 - Copper central conductor
 - Copper flat strap concentric neutral
 - Product identification via colored jackets.
 - Semiconducting jackets.
 - Improved Temperature Rating.
- Okoguard insulation system has been tested and qualified for operation at 105°C continuous and 140°C emergency operating temperature.
- Minimum installation temperature of -40°C.

Okoguard URO-J

15kV Underground Primary Distribution Cable-Jacketed

Red Identification Stripes

Filled Strand Aluminum Conductor/105°C Rating
100% Insulation Level

Product Data

Section 2: Sheet 36



Okoguard Insulation: 175 mils 100% Insulation Level

Catalog Number	Conductor size (AWG or kcmil)	Nominal Dia. over Insulation (in.)		Insulation Screen Thickness (mils)	Nominal Dia. over Insulation Screen (in.)	Copper Neutral, No. x AWG (1)	Nominal O.D. (in.)	Approx. Net Weight lbs./1000'		Approx. Ship Weight lbs./1000'		90°C Ampacity Direct Burial (2)	90°C Ampacity Duct (2)	105°C Ampacity Direct Burial (2)	105°C Ampacity Duct (2)
FULL NEUTRAL															
▲ 163-23-2060	2(7X)	0.68	30	0.75	10X14	0.99	517	626	170	125	185	135			
163-23-2066	1(19X)	0.72	30	0.79	13X14	1.03	588	698	195	145	210	155			
▲ 163-23-2072	1/0(19X)	0.76	30	0.83	16X14	1.07	667	778	220	160	235	175			
163-23-2075	2/0(19X)	0.80	30	0.87	14X12	1.14	793	910	250	185	270	205			
163-23-2078	3/0(19X)	0.85	30	0.92	16X12	1.19	910	1029	285	210	310	230			
163-23-2081	4/0(19X)	0.90	30	0.98	14X10	1.29	1131	1238	320	240	350	260			
163-23-2084	250(37X)	0.97	30	1.04	16X10	1.35	1270	1418	350	270	380	295			
163-23-2090	350(37X)	1.07	40	1.17	18X.1078	1.50	1603	1793	425	310	460	340			
1/3 NEUTRAL															
162-23-2060	2(7X)	0.69	30	0.76	6X14	1.00	475	579	150	120	165	135			
162-23-2066	1(19X)	0.72	30	0.79	6X14	1.03	506	617	175	140	185	150			
162-23-2072	1/0(19X)	0.76	30	0.83	6X14	1.07	550	662	195	155	215	170			
162-23-2075	2/0(19X)	0.80	30	0.87	7X14	1.11	612	726	225	180	240	195			
162-23-2078	3/0(19X)	0.85	30	0.92	9X14	1.16	697	889	255	200	275	220			
162-23-2081	4/0(19X)	0.90	30	0.98	11X14	1.21	794	922	285	235	310	255			
162-23-2084	250(37X)	0.97	30	1.04	13X14	1.28	895	1018	305	250	330	275			
162-23-2090	350(37X)	1.07	40	1.17	18X14	1.41	1138	1315	375	310	405	335			
162-23-2093	500(37X)	1.20	40	1.30	16X12	1.57	1476	1691	450	370	490	405			
162-23-2096	750(61X)	1.39	40	1.49	16X.0966	1.86	2066	2402	545	460	595	505			
162-23-2099	1000(61X)	1.54	40	1.68	18X.1052	2.06	2645	3059	620	520	675	570			

Okonite's web site, www.okonite.com contains the most up to date information.

(1) Individual wire size and count may vary. The resulting combination meets the 1/3 or full neutral, size requirement.

▲ **Authorized stock item.** Available from our Customer Service Centers.

Ampacities

(2) Full neutral, single phase ampacities are based on ICEA P-117-734 for 90°C or 105°C conductor temperature, 25°C ambient temperature, 100% load factor, and earth thermal resistivity of RHO 90.
One third neutral ampacities are based on triplexed or triangular configuration for the same conditions stated above.

Okoguard URO-J

15kV Underground Primary Distribution Cable-Jacketed

Red Identification Stripes

Filled Strand Aluminum Conductor/105°C Rating
133% Insulation Levels



Product Data

Section 2: Sheet 36

Okoguard Insulation: 220 mils 133% Insulation Level

Catalog Number	Conductor size (AWG or kcmil)	Nominal Dia. over Insulation (in.)	Insulation Screen Thickness (mils)	Nominal Dia. over Insulation Screen (in.)	Copper Neutral, No. x AWG (1)	Nominal O.D. (in.)	Approx. Net Weight lbs./1000'	Approx. Ship Weight lbs./1000'	90°C Ampacity Direct Burial (2)	90°C Ampacity Duct (2)	105°C Ampacity Direct Burial (2)	105°C Ampacity Duct (2)
FULL NEUTRAL												
▲ 163-23-3060	2(7X)	0.77	30	0.84	10X14	1.08	591	669	170	125	185	135
163-23-3066	1(19X)	0.81	30	0.88	13X14	1.12	670	766	195	145	210	155
▲ 163-23-3072	1/0(19X)	0.84	30	0.92	16X14	1.15	748	820	220	160	235	175
163-23-3075	2/0(19X)	0.89	30	0.96	14X12	1.23	902	996	250	185	270	205
163-23-3078	3/0(19X)	0.94	30	1.01	16X12	1.28	1004	1125	285	210	310	230
163-23-3081	4/0(19X)	0.98	30	1.06	14X10	1.38	1228	1347	320	240	350	260
163-23-3084	250(37X)	1.06	40	1.16	16X10	1.47	1410	1606	350	270	380	295
163-23-3090	350(37X)	1.16	40	1.26	18X.1078	1.59	1721	1912	425	310	460	340
1/3 NEUTRAL												
162-23-3060	2(7X)	0.77	30	0.84	6X14	1.08	544	627	150	120	165	135
162-23-3066	1(19X)	0.81	30	0.88	6X14	1.12	588	684	175	140	185	150
162-23-3072	1/0(19X)	0.84	30	0.92	6X14	1.15	631	733	195	155	215	170
162-23-3075	2/0(19X)	0.89	30	0.96	7X14	1.20	701	810	225	180	240	195
162-23-3078	3/0(19X)	0.94	30	1.01	9X14	1.25	789	905	255	200	275	220
▲ 162-23-3081	4/0(19X)	0.98	30	1.06	11X14	1.30	887	1005	285	235	310	255
162-23-3084	250(37X)	1.06	40	1.16	13X14	1.40	1029	1164	305	250	330	275
▲ 162-23-3090	350(37X)	1.16	40	1.26	18X14	1.50	1246	1425	375	310	405	335
▲ 162-23-3093	500(37X)	1.29	40	1.39	16X12	1.67	1600	1787	450	370	490	405
▲ 162-23-3096	750(61X)	1.47	40	1.58	16X.0966	1.95	2209	2468	545	460	595	505
▲ 162-23-3099	1000(61X)	1.64	55	1.77	18X.1052	2.16	2807	3093	620	520	675	570

Okonite's web site, www.okonite.com contains the most up to date information.

(1) Individual wire size and count may vary. The resulting combination meets the 1/3 or full neutral, size requirement.

▲ **Authorized Stock Item** - Available from Customer Service centers.

Ampacities

(2) Full neutral, single phase ampacities are based on ICEA P-117-734 for 90°C or 105°C conductor temperature, 25°C ambient temperature, 100% load factor, and earth thermal resistivity of RHO 90.

One third neutral ampacities are based on triplexed or triangular configuration for the same conditions stated above.



Okoguard® URO-J

25kV Underground Primary Distribution Cable-Jacketed Red Identification Stripes

Aluminum Conductor/105°C Rating
100% and 133% Insulation Levels



- A Conductor-Stranded Aluminum
- B Strand Screen - Extruded Semiconducting EPR
- C Insulation-Okoguard EPR
- D Insulation Screen - Extruded Semiconducting EPR
- E Concentric Conductor-Bare Copper Wires
- F Encapsulating Jacket-Okolene with three extruded red ID Stripes, and NESC lightning bolt

Insulation

Okoguard is Okonite's registered trade name for its exclusive ethylene-propylene rubber (EPR) based, thermosetting compound, whose optimum balance of electrical and physical properties is unequalled in other solid dielectrics. Okoguard insulation, with the distinctive red color and a totally integrated EPR system, provides the optimum balance of electrical and physical properties for long, problem free service.

The triple tandem extrusion of the screens with the insulation provides optimum electrical characteristics.

An insulation screen of ethylene-propylene rubber is extruded over the insulation. The bare copper concentric wires are uniformly spaced around the insulation screen. The overall polyethylene jacket provides protection against mechanical damage and corrosion. Product identification is provided through the use of three red stripes placed 120° apart in the black jacket with an NESC lightning bolt.

Applications

Okoguard URO-J cables provide maximum circuit longevity in underground residential distribution systems. They can be buried directly or installed in underground ducts or conduits.

Specifications

Central Conductor: Aluminum per ASTM B-609, Class B stranded per B-231.

Conductor Screen: Extruded semiconducting ethylene-propylene rubber meets or exceeds the requirements of ICEA S-94-649, AEIC CS8, and CSA C68.5.

Insulation: Extruded Okoguard meets or exceeds the requirements of ICEA S-94-649, AEIC CS8, and CSA C68.5.

Insulation Screen: Extruded semiconducting ethylene-propylene rubber meets or exceeds the requirements of ICEA S-94-649, AEIC CS8, and CSA C68.5.

Concentric Conductor: Bare copper wires.

Jacket: Black Okolene with red extruded stripes meets or exceeds the requirements of ICEA S-94-649, AEIC CS8, and CSA C68.5 for polyethylene jackets.

Product Features

- Triple tandem extruded, all EPR system.
 - Okoguard cables meet or exceed ICEA standards.
 - Meets RUS 1728.204 for cables with filled strand or solid conductor and 100% insulation level.
 - 105°C continuous operating temperature.
 - 140°C emergency rating.
 - 250°C short circuit rating.
 - Excellent corona resistance.
 - Low dielectric constant and power factor.
 - Screens are clean stripping.
 - Exceptional resistance to "treeing".
 - Moisture resistant.
 - Overall jacket provides extended life.
 - Red extruded stripes.
 - Excellent resistance to most chemicals.
 - Can be listed by UL as Type MV-90 on Special Orders.
 - CSAC68.5 listed, LTGG (-40°C), SR.
 - Design Options:
 - Additional conductor sizes
 - Filled strand
 - Copper central conductor
 - Copper flat strap concentric neutral
 - Product identification via colored jackets
 - Semiconducting jackets
 - Improved Temperature Rating.
- Okoguard insulation system has been tested and qualified for operation at 105°C continuous and 140°C emergency operating temperature.
- Minimum installation temperature of -40°C.

Okoguard URO-J

25kV Underground Primary Distribution Cable-Jacketed

Red Identification Stripes

Aluminum Conductor/105°C Rating
100% Insulation Levels

Product Data

Section 2: Sheet 39



Okoguard Insulation: 260 mils 100% Insulation Level

Catalog Number	Conductor size (AWG or kcmil)	Nominal Dia. over Insulation (in.)	Insulation Screen Thickness (mils)	Nominal Dia. over Insulation Screen (in.)	Copper Neutral No. x AWG (1)	Nominal O.D. (in.)	Approx. Net Weight lbs./1000'	Approx. Ship Weight lbs./1000'	90°C Ampacity Direct Burial (2)	90°C Ampacity Duct (2)	105°C Ampacity Direct Burial (2)	105°C Ampacity Duct (2)
FULL NEUTRAL												
161-23-4066	1(19X)	0.89	30	0.96	13X14	1.20	747	872	195	145	210	155
▲ 161-23-4069	1/0(1X)	0.89	30	0.97	16X14	1.20	798	870	220	160	235	175
161-23-4072	1/0(19X)	0.93	30	1.00	16X14	1.24	832	898	220	160	235	175
161-23-4075	2/0(19X)	0.97	30	1.05	14X12	1.32	986	1117	250	185	270	205
161-23-4078	3/0(19X)	1.02	30	1.01	16X12	1.37	1092	1210	285	210	310	230
161-23-4081	4/0(19X)	1.08	40	1.18	14X10	1.49	1357	1550	320	240	350	260
161-23-4084	250(37X)	1.14	40	1.24	16X10	1.55	1507	1724	350	270	380	295
161-23-4090	350(37X)	1.25	40	1.35	18X.1078	1.74	1887	2166	425	310	460	340

1/3 NEUTRAL												
160-23-4066	1(19X)	0.88	30	0.96	6X14	1.19	659	791	175	140	185	150
160-23-4072	1/0(19X)	0.93	30	1.00	6X14	1.24	715	841	195	155	215	170
160-23-4075	2/0(19X)	0.97	30	1.05	7X14	1.28	784	912	225	180	240	195
160-23-4078	3/0(19X)	1.02	30	1.01	9X14	1.33	875	994	255	200	275	220
160-23-4081	4/0(19X)	1.08	40	1.18	11X14	1.41	1011	1128	285	235	310	255
160-23-4084	250(37X)	1.14	40	1.24	13X14	1.47	1115	1330	305	250	330	275
160-23-4090	350(37X)	1.24	40	1.34	18X14	1.58	1347	1566	375	310	405	335
160-23-4093	500(37X)	1.38	40	1.48	16X12	1.81	1777	1986	450	370	490	405
160-23-4096	750(61X)	1.57	40	1.67	16X.0966	2.03	2396	3156	545	460	595	505
160-23-4099	1000(61X)	1.72	55	1.85	18X.1052	2.24	2952	3533	620	520	675	570

Okonite's web site, www.okonite.com contains the most up to date information.

(1) Individual wire size and count may vary. The resulting combination meets the 1/3 or full neutral, size requirement.

▲ **Authorized Stock Item** - Available from Customer Service Centers.

Ampacities

(2) Full neutral, single phase ampacities are based on ICEA P-117-734 for 90°C or 105°C conductor temperature, 25°C ambient temperature, 100% load factor, and earth thermal resistivity of RHO 90.

One third neutral ampacities are based on triplexed or triangular configuration for the same conditions stated above.

Okoguard URO-J

25kV Underground Primary Distribution Cable-Jacketed

Red Identification Stripes

Aluminum Conductor/105°C Rating
133% Insulation Levels

Product Data

Section 2: Sheet 39



Okoguard Insulation: 320 mils 133% Insulation Level

Catalog Number	Conductor size (AWG or kcmil)	Number of Strands	Nominal Dia. over Insulation (in.)	Insulation Screen Thickness (mils)	Nominal Dia. over Insulation Screen (in.)	Copper Full Neutral No. x AWG (1)	Nominal O.D. (in.)	Approx. Net Weight lbs./1000'	Approx. Ship Weight lbs./1000'	90°C Ampacity Direct Burial (2)	105°C Ampacity Duct (2)	105°C Ampacity Direct Burial (2)
FULL NEUTRAL												
161-23-5066	1(19X)	1.01	40	1.09	13X14	1.32	876	1047	195	145	210	155
161-23-5072	1/0(19X)	1.05	40	1.15	16X14	1.39	994	1138	220	160	235	175
161-23-5075	2/0(19X)	1.09	40	1.19	14X12	1.46	1157	1353	250	185	270	205
161-23-5078	3/0(19X)	1.14	40	1.24	16X12	1.51	1269	2503	285	210	310	230
161-23-5081	4/0(19X)	1.20	40	1.30	14X10	1.61	1514	1819	320	240	350	260
161-23-5084	250(37X)	1.26	40	1.36	16X10	1.74	1733	2032	350	270	380	295
161-23-5090	350(37X)	1.37	40	1.47	18X.1074	1.86	2068	2349	425	310	460	340

1/3 NEUTRAL												
160-23-5066	1(19X)	1.01	40	1.09	6X14	1.32	793	966	175	140	185	150
160-23-5072	1/0(19X)	1.05	40	1.15	6X14	1.39	877	1022	195	155	215	170
160-23-5075	2/0(19X)	1.09	40	1.19	7X14	1.43	952	1099	225	180	240	195
160-23-5078	3/0(19X)	1.14	40	1.24	9X14	1.48	1049	1261	255	200	275	220
160-23-5081	4/0(19X)	1.20	40	1.30	11X14	1.54	1162	1378	285	235	310	255
160-23-5084	250(37X)	1.26	40	1.36	13X14	1.60	1281	1490	305	250	330	275
160-23-5090	350(37X)	1.37	40	1.47	18X14	1.77	1588	1881	375	310	405	335
160-23-5093	500(37X)	1.50	40	1.60	16X12	1.93	1968	2275	450	370	490	405
160-23-5096	750(61X)	1.68	55	1.82	16X.0966	2.20	2647	3122	545	460	595	505
160-23-5099	1000(61X)	1.84	55	1.98	18X.1052	2.36	3189	3771	620	520	675	570

Okonite's web site, www.okonite.com contains the most up to date information.

(1) Individual wire size and count may vary. The resulting combination meets the 1/3 or full neutral, size requirement.

Ampacities

(2) Full neutral, single phase ampacities are based on ICEA P-117-734 for 90°C or 105°C conductor temperature, 25°C ambient temperature, 100% load factor, and earth thermal resistivity of RHO 90.

One third neutral ampacities are based on triplexed or triangular configuration for the same conditions stated above.



Okoguard[®] URO-J

35kV Underground Primary Distribution Cable-Jacketed Red Identification Stripes

Aluminum Conductor/105°C Rating
100% and 133% Insulation Levels



- A Conductor-Stranded Aluminum
- B Strand Screen- Extruded Semiconducting EPR
- C Insulation-Okoguard EPR
- D Insulation Screen- Extruded Semiconducting EPR
- E Concentric Conductor-Bare Copper Wires
- F Encapsulating Jacket-Okolene with three extruded red ID stripes and NESC lightning bolt

Insulation

Okoguard is Okonite's registered trade name for its exclusive ethylene-propylene rubber (EPR) based, thermosetting compound, whose optimum balance of electrical and physical properties is unequalled in other solid dielectrics. Okoguard insulation, with the distinctive red color and a totally integrated EPR system, provides the optimum balance of electrical and physical properties for long, problem free service.

The triple tandem extrusion of the screens with the insulation provides optimum electrical characteristics.

An insulation screen of ethylene-propylene rubber is extruded over the insulation. The bare copper concentric wires are uniformly spaced around the insulation screen. The overall polyethylene jacket provides protection against mechanical damage and corrosion.

Product identification is provided through the use of three red stripes placed 120° apart in the black jacket, with an NESC lightning bolt.

Applications

Okoguard URO-J cables provide maximum circuit longevity in underground residential distribution systems. They can be buried directly or installed in underground ducts or conduits.

Specifications

Central Conductor: Aluminum per ASTM B609, Class B stranded per B231.

Conductor Screen: Extruded semiconducting ethylene-propylene rubber meets or exceeds the requirements of ICEA S-94-649, AEIC CS8, and CSA C68.5.

Insulation: Extruded Okoguard meets or exceeds the requirements of ICEA S-94-649, AEIC CS8, and CSA C68.5.

Insulation Screen: Extruded semiconducting ethylene-propylene rubber meets or exceeds the requirements of ICEA S-94-649, AEIC CS8, and CSA C68.5.

Concentric Conductor: Bare copper wires.

Jacket: Black Okolene with red extruded stripes meets or exceeds the requirements of ICEA S-94-649, AEIC CS8, and CSA C68.5 for polyethylene jackets.

Product Features

- Triple tandem extruded, all EPR system.
- Okoguard cables meet or exceed ICEA standards.
- Meets RUS 1728.204 for cables with filled strand or solid conductor and 100% insulation level.
- 105°C continuous operating temperature
- 140°C emergency rating
- 250°C short circuit rating
- Excellent corona resistance.
- Low dielectric constant and power factor.
- Screens are clean stripping.
- Exceptional resistance to "treeing".
- Moisture resistant.
- Overall jacket provides extended life.
- Excellent resistance to most chemicals.
- Can be listed by UL as Type MV-90 on Special Orders.
- CSA C68.5 listed, LTGG (-40°C), SR.
- Design Options:
 - Additional conductor sizes
 - Filled strand
 - Copper central conductor
 - Copper flat strap concentric neutral
 - Product identification via colored jackets
 - Semiconducting jackets
- Improved Temperature Rating. Okoguard insulation system has been tested and qualified for operation at 105°C continuous and 140°C emergency operating temperature. Appropriate jacket should be selected when cable is to be operated at these higher temperatures.
- Minimum installation temperature of -40°C.

Okoguard® URO-J

35kV Underground Primary Distribution Cable-Jacketed

Red Identification Stripes

Aluminum Conductor/105°C Rating

100% Insulation Level



Product Data Section 2: Sheet 40

Okoguard Insulation: 345 mils 100% Insulation Level

Catalog Number	Conductor Size AWG/kcmil	Nominal Dia. Over Insulation	Insulation Screen Thickness (mils)	Nominal Dia. Over Insulation Screen	Copper Neutral Number x AWG (1)	Nominal O.D. (In.)	Approx. Net Weight lbs./1000'	Approx. Ship Weight lbs./1000'	90°C Ampacity (2) Direct Burial	90°C Ampacity Duct (2)	105°C Ampacity (2) Direct Burial	105°C Ampacity Duct (2)
FULL NEUTRAL												
161-23-6072	1/0 (19x)	1.10	40	1.20	16x14	1.44	1055	1179	205	165	225	180
161-23-6075	2/0 (19x)	1.15	40	1.25	14x12	1.52	1231	1416	240	190	260	205
161-23-6078	3/0 (19x)	1.20	40	1.30	16x12	1.57	1336	1552	270	215	295	230
161-23-6081	4/0 (19x)	1.26	40	1.36	14x10	1.74	1657	1921	310	240	335	265
161-23-6084	250 (37x)	1.31	40	1.41	16x10	1.79	1805	2106	340	265	370	290
161-23-6090	350 (37x)	1.42	40	1.52	18x.1078	1.91	2146	2525	410	320	445	350

1/3 NEUTRAL												
160-23-6072	1/0 (19x)	1.10	40	1.20	6x14	1.44	938	1082	195	160	210	175
160-23-6075	2/0 (19x)	1.15	40	1.25	7x14	1.48	1015	1223	220	185	240	200
160-23-6078	3/0 (19x)	1.20	40	1.30	9x14	1.54	1125	1326	250	210	270	230
160-23-6081	4/0 (19x)	1.26	40	1.36	11x14	1.60	1241	1445	285	235	310	260
160-23-6084	250 (37x)	1.31	40	1.41	13x14	1.72	1411	1701	305	255	330	280
160-23-6090	350 (37x)	1.42	40	1.52	18x14	1.82	1663	1957	370	315	405	345
160-23-6093	500 (37x)	1.55	40	1.65	16x12	1.98	2058	2515	450	380	485	415
160-23-6096	750 (61x)	1.74	55	1.88	16x.0966	2.24	2727	3323	545	470	595	515
160-23-6099	1000 (61x)	1.89	55	2.03	18x.1052	2.41	3289	3872	620	530	675	585

Okonite's web site, www.okonite.com contains the most up to date information.

(1) Individual wire size and count may vary. The resulting combination meets the 1/3 or full neutral, size requirement.

Ampacities

(2) Full neutral, single phase ampacities are based on ICEA P-117-734 for 90°C or 105°C conductor temperature, 25°C ambient temperature, 100% load factor, and earth thermal resistivity of RHO 90. One third neutral ampacities are based on triplexed or triangular configuration for the same conditions stated above.

Okoguard® URO-J

35kV Underground Primary Distribution Cable-Jacketed

Red Identification Stripes

Aluminum Conductor/105°C Rating

133% Insulation Level



Product Data Section 2: Sheet 40

Okoguard Insulation: 420 mils 133% Insulation Level

Catalog Number	Conductor Size AWG/kcmil	Number of Strands	Nominal Dia. Over Insulation	Insulation Screen Thickness (mils)	Nominal Dia. Over Insulation Screen	Copper Neutral Number x AWG (1)	Nominal O.D. (In.)	Approx. Net Weight lbs./1000'	Approx. Ship Weight lbs./1000'	90°C Ampacity (2) Direct Burial	90°C Ampacity (2) 105°C Ampacity Duct (2)	105°C Ampacity (2) Direct Burial	105°C Ampacity (2) 105°C Ampacity Duct (2)
FULL NEUTRAL													
161-23-7072	1/0 (19x)	1.26	40	1.36	16x14	1.59	1250	1463	205	165	225	180	
161-23-7075	2/0 (19x)	1.31	40	1.41	14x12	1.74	1503	1770	240	190	260	205	
161-23-7078	3/0 (19x)	1.35	40	1.45	16x12	1.78	1608	1916	270	215	295	230	
161-23-7081	4/0 (19x)	1.41	40	1.51	14x10	1.89	1891	2159	310	240	335	265	
161-23-7084	250 (37x)	1.47	40	1.57	16x10	1.95	2048	2352	340	265	370	290	
161-23-7090	350 (37x)	1.57	40	1.67	18x.1078	2.06	2416	2846	410	320	445	350	
1/3 NEUTRAL													
160-23-7072	1/0 (19x)	1.26	40	1.36	6x14	1.59	1133	1347	195	160	210	175	
160-23-7075	2/0 (19x)	1.31	40	1.41	7x14	1.71	1292	1573	220	185	240	200	
160-23-7078	3/0 (19x)	1.36	40	1.46	9x14	1.76	1401	1684	250	210	270	230	
160-23-7081	4/0 (19x)	1.40	40	1.50	11x14	1.80	1509	1814	285	235	310	260	
160-23-7084	250 (37x)	1.47	40	1.57	13x14	1.87	1646	1939	305	255	330	280	
160-23-7090	350 (37x)	1.56	40	1.67	18x14	1.97	1919	2367	370	315	405	345	
160-23-7093	500 (37x)	1.69	55	1.83	16x12	2.16	2370	2846	450	380	485	415	
160-23-7096	750 (61x)	1.90	55	2.03	16x.0966	2.40	3032	3632	545	470	595	515	
160-23-7099	1000 (61x)	2.05	55	2.18	18x.1052	2.57	3617	4202	620	530	675	585	

Okonite's web site, www.okonite.com contains the most up to date information.

(1) Individual wire size and count may vary. The resulting combination meets the 1/3 or full neutral, size requirement.

Ampacities

(2) Full neutral, single phase ampacities are based on ICEA P-117-734 for 90°C or 105°C conductor temperature, 25°C ambient temperature, 100% load factor, and earth thermal resistivity of RHO 90. One third neutral ampacities are based on triplexed or triangular configuration for the same conditions stated above.



Okoguard® URO-J®

15kV to 35kV Underground Primary Distribution Cable

Jacketed-Red Identification Stripes

Copper Conductor/105°C Rating

100% and 133% Insulation Levels



- A Conductor-Compressed or Compact Round Copper
- B Strand Screen - Extruded Semiconducting EPR
- C Insulation-Okoguard-EPR
- D Insulation Screen - Extruded Semiconducting EPR
- E Concentric Conductor-Bare Copper Wires
- F Encapsulating Jacket-Okolene with 3 extruded red ID stripes, and NESC Lightning bolt

Insulation

Okoguard® is Okonite's registered trade name for its exclusive ethylene-propylene rubber (EPR) based, thermosetting compound, whose optimum balance of electrical and physical properties is unequalled in other solid dielectrics. Okoguard® insulation, with the distinctive red color and a totally integrated EPR system, provides the optimum balance of electrical and physical properties for long, problem-free service.

The triple tandem extrusion of the screens with the insulation provides optimum electrical characteristics.

An insulation screen of ethylene-propylene rubber is extruded over the insulation. The bare concentric copper wires are uniformly spaced around the insulation screen. The overall polyethylene jacket provides protection against mechanical damage and corrosion.

Product identification is provided through the use of three red stripes placed 120° apart in the black jacket with an NESC Lightning bolt.

Applications

Okoguard URO-J® cables provide maximum circuit longevity in underground residential distribution systems. They can be buried direct or installed in underground ducts or conduits.

Specifications

Central Conductor: Uncoated soft copper. Compressed round conductors per ASTM B-3 and ASTM B-8. Compact round conductors per ASTM B-496.

Conductor Screen: Extruded semiconducting ethylene-propylene rubber meets or exceeds the requirements of ICEA S-94-649, AEIC CS8, and CSA C68.5.

Insulation: Extruded Okoguard® meets or exceeds the requirements of ICEA S-94-649, AEIC CS8, and CSA C68.5.

Insulation Screen: Two insulation screen thicknesses are available:

Cables with Compressed Round Copper Copper conductors have extruded semiconducting ethylene-propylene rubber insulation screens that meet the requirements of ICEA S-94-649, AEIC CS8, and CSA C68.5.

Cables with Compact Round Copper conductors have extruded semiconducting ethylene-propylene rubber insulation screens that meet the requirements of ICEA S-93-639/NEMA WC74 & S-97-682, and AEIC CS8.

Concentric Conductor: Bare copper wires.

Jacket: Black Okolene® with red extruded stripes meets or exceeds the requirements of ICEA S-94-649, AEIC CS8, and CSA C68.5 for polyethylene jackets.

Product Features

- Triple tandem extruded, all EPR system
- Okoguard cables meet or exceed ICEA standards.
- 105°C continuous operating temperatures
- 140°C emergency rating
- 250°C short circuit rating
- Excellent corona resistance.
- Low dielectric constant and power factor.
- Screens are clean stripping.
- Exceptional resistance to "treeing".
- Moisture resistant.
- Excellent resistance to most chemicals.
- Can be listed by UL as Type MV-90 on Special Orders.
- CSA C68.5 listed, LTGG (-40°C), SR.
- Design Options:
 - Additional conductor sizes
 - Filled strand
 - Copper flat strap concentric neutral
 - Product identification via colored jackets.
 - Semiconducting jacket.
- Improved Temperature Rating.

Okoguard insulation system has been tested and qualified for operation at 105°C continuous and 140°C emergency operating temperature.

These cables can be supplied with the following jackets for an MV-105 rating:

- FR-PVC Jacket, MV-105.
- XLPE Jacket, MV-105.

Okoguard® URO-J
Copper Compressed Round Conductor/105°C Rating
(with ICEA S-94-649 Insulation Screen Thickness)



Product Data
Section 2: Sheet 42

Catalog Number	Conductor Size AWG/kcmil	Nominal Dia. over Insulation (in.)	Insulation Screen Thickness (mils)	Nominal Dia. over Insulation Screen (in.)	Copper Neutral No. x AWG (1)	Nominal O.D. (in.)	Approx. Net Weight (lbs./1000')	Approx. Ship Weight (lbs./1000')	90°C Ampacity Direct Burial (2)	90°C Ampacity Duct (2)	105°C Ampacity Direct Burial (2)	105°C Ampacity Duct (2)
15kV - 175 mils (4.45mm), 100% Insulation Level												
Full Neutral												
141-23-2060	2(7x)	0.68	30	0.75	16x14	0.99	725	775	210	160	230	175
141-23-2066	1(19x)	0.72	30	0.79	14x12	1.06	890	959	235	180	260	200
141-23-2072	1/0(19x)	0.76	30	0.83	16x12	1.10	1017	1086	270	205	290	225
141-23-2075	2/0(19x)	0.80	30	0.87	14x10	1.19	1273	1380	310	235	335	255
141-23-2078	3/0(19x)	0.85	30	0.92	16x10	1.24	1468	1617	350	265	380	290
141-23-2081	4/0(19x)	0.90	30	0.98	18x.1073	1.30	1763	1912	405	305	440	330
1/3 Neutral												
140-23-2060	2(7x)	0.68	30	0.75	6x14	0.99	608	658	195	160	210	175
140-23-2066	1(19x)	0.72	30	0.79	7x14	1.03	693	743	220	180	240	195
140-23-2072	1/0(19x)	0.76	30	0.83	9x14	1.07	805	874	250	200	275	220
140-23-2075	2/0(19x)	0.80	30	0.87	11x14	1.11	937	1006	285	230	310	250
140-23-2078	3/0(19x)	0.85	30	0.92	14x14	1.16	1106	1183	325	260	350	285
140-23-2081	4/0(19x)	0.90	30	0.98	18x14	1.21	1318	1413	365	300	395	325
140-23-2084	250(37x)	0.97	30	1.04	14x12	1.31	1549	1683	395	325	430	355
140-23-2090	350(37x)	1.07	40	1.17	18x12	1.44	2021	2207	475	390	515	425
140-23-2093	500(37x)	1.20	40	1.30	18x.0953	1.60	2721	2959	555	455	610	500
140-23-2096	750(61x)	1.39	40	1.49	24x.1010	1.87	3925	4862	650	545	710	600
140-23-2099	1000(61x)	1.54	40	1.64	24x.1167	2.05	5083	5502	815	685	885	750
15kV - 220 mils (5.59mm), 133% Insulation Level												
Full Neutral												
141-23-3060	2(7x)	0.77	30	0.84	16x14	1.08	803	871	210	160	230	175
141-23-3066	1(19x)	0.81	30	0.88	14x12	1.15	973	1055	235	180	260	200
141-23-3072	1/0(19x)	0.85	30	0.92	16x12	1.19	1103	1185	270	205	290	225
141-23-3075	2/0(19x)	0.89	30	0.96	14x10	1.28	1362	1454	310	235	335	255
141-23-3078	3/0(19x)	0.94	30	1.01	16x10	1.33	1561	1663	350	265	380	290
141-23-3081	4/0(19x)	0.99	30	1.07	18x.1073	1.39	1864	1953	405	305	440	330
1/3 Neutral												
140-23-3060	2(7x)	0.77	30	0.84	6x14	1.08	686	755	195	160	210	175
140-23-3066	1(19x)	0.81	30	0.88	7x14	1.12	774	858	220	180	240	195
140-23-3072	1/0(19x)	0.85	30	0.92	9x14	1.16	890	972	250	200	275	220
140-23-3075	2/0(19x)	0.89	30	0.96	11x14	1.20	1025	1105	285	230	310	250
140-23-3078	3/0(19x)	0.94	30	1.01	14x14	1.25	1198	1290	325	260	350	285
140-23-3081	4/0(19x)	0.99	30	1.07	18x14	1.31	1414	1506	365	300	395	325
140-23-3084	250(37x)	1.06	40	1.16	14x12	1.43	1683	1798	395	325	430	355
140-23-3090	350(37x)	1.16	40	1.26	18x12	1.53	2130	2276	475	390	515	425
140-23-3093	500(37x)	1.29	40	1.39	18x.0953	1.77	2953	3146	555	455	610	500
140-23-3096	750(61x)	1.49	40	1.59	24x.1010	1.96	4071	4353	650	545	710	600
140-23-3099	1000(61x)	1.64	55	1.77	24x.1167	2.18	5306	5667	815	685	885	750

Okonite's web site, www.okonite.com contains the most up to date information.
 (1) individual wire size and count may vary. The resulting combination meets 1/3 or full neutral, size requirement.

Okoguard[®] URO-J

Copper Compressed Round Conductor/105°C Rating
(with ICEA S-94-649 Insulation Screen Thickness)



Product Data Section 2: Sheet 42

Catalog Number	Conductor Size AWG/kcmil	Nominal Dia. over Insulation (in.)	Insulation Screen Thickness (mils)	Nominal Dia. over Insulation Screen (in.)	Copper Neutral No. x AWG (1)	Nominal O.D. (in.)	Approx. Net Weight (lbs./1000')	Approx. Ship Weight (lbs./1000')	90°C Ampacity Direct Burial (2)	90°C Ampacity Duct (2)	105°C Ampacity Direct Burial (2)	105°C Ampacity Duct (2)
25kV - 260 mils (6.60mm), 100% Insulation Level												
Full Neutral												
141-23-4066	1(19x)	0.89	30	0.96	14x12	1.23	1053	1165	235	180	260	200
141-23-4072	1/0(19x)	0.93	30	1.00	16x12	1.27	1187	1305	270	205	290	225
141-23-4075	2/0(19x)	0.97	30	1.04	14x10	1.36	1451	1569	310	235	335	255
141-23-4078	3/0(19x)	1.02	40	1.12	16x10	1.43	1683	1835	350	265	380	290
141-23-4081	4/0(19x)	1.08	40	1.18	18x.1073	1.50	1992	2139	405	305	440	330
1/3 Neutral												
140-23-4066	1(19x)	0.89	30	0.96	7x14	1.20	853	921	220	180	240	195
140-23-4072	1/0(19x)	0.93	30	1.00	9x14	1.24	972	1083	250	200	275	220
140-23-4075	2/0(19x)	0.97	30	1.05	11x14	1.28	1110	1226	285	230	310	250
140-23-4078	3/0(19x)	1.02	30	1.10	14x14	1.33	1287	1433	325	260	350	285
140-23-4081	4/0(19x)	1.08	40	1.18	18x14	1.41	1537	1654	365	300	395	325
140-23-4084	250(37x)	1.14	40	1.24	14x12	1.51	1783	1965	395	325	430	355
140-23-4090	350(37x)	1.24	40	1.34	18x12	1.61	2235	2423	475	390	515	425
140-23-4093	500(37x)	1.38	40	1.48	18x.0953	1.84	3032	3408	555	455	610	500
140-23-4096	750(61x)	1.57	40	1.70	24x.1010	2.08	4285	4622	650	545	710	600
140-23-4099	1000(61x)	1.72	55	1.85	24x.1167	2.26	5458	5817	815	685	885	750
35kV - 345 mils (8.76mm), 100% Insulation Level												
Full Neutral												
141-23-6072	1/0(19x)	1.11	40	1.21	16x12	1.48	1424	1564	265	210	285	230
141-23-6075	2/0(19x)	1.13	40	1.23	14x10	1.55	1678	1840	305	235	330	255
141-23-6078	3/0(19x)	1.20	40	1.30	16x10	1.61	1909	2052	345	270	375	295
141-23-6081	4/0(19x)	1.26	40	1.36	18x.1073	1.75	2293	2439	395	305	430	330
1/3 Neutral												
140-23-6072	1/0(19x)	1.11	40	1.21	9x14	1.45	1205	1344	250	210	270	230
140-23-6075	2/0(19x)	1.15	40	1.25	11x14	1.49	1351	1489	280	235	305	260
140-23-6078	3/0(19x)	1.20	40	1.30	14x14	1.54	1537	1676	320	265	345	290
140-23-6081	4/0(19x)	1.26	40	1.36	18x14	1.60	1767	1906	360	300	395	330
140-23-6084	250(37x)	1.31	40	1.41	14x12	1.75	2076	2235	390	330	425	365
140-23-6090	350(37x)	1.42	40	1.52	18x12	1.85	2556	2736	470	400	510	435
140-23-6093	500(37x)	1.55	40	1.65	18x.0953	2.01	3320	3789	555	470	605	515
140-23-6096	750(61x)	1.74	55	1.88	24x.1010	2.25	4598	5163	650	560	710	620
140-23-6099	1000(61x)	1.89	55	2.03	24x.1167	2.43	5797	6323	815	700	885	770
35kV - 420 mils (10.67mm), 133% Insulation Level												
Full Neutral												
141-23-7022	1/0(19x)	1.27	40	1.37	16x12	1.64	1628	1832	265	210	285	230
141-23-7025	2/0(19x)	1.31	40	1.41	14x10	1.79	1980	2226	305	235	330	260
141-23-7028	3/0(19x)	1.36	40	1.46	16x10	1.84	2201	2447	345	270	375	290
141-23-7031	4/0(19x)	1.41	40	1.51	18x.1073	1.90	2528	2778	395	305	430	330
1/3 Neutral												
140-23-9923	1/0(19x)	1.27	40	1.37	9x14	1.60	1406	1594	250	210	270	230
140-23-9931	2/0(19x)	1.31	40	1.41	11x14	1.71	1619	1823	280	235	305	255
140-23-9932	3/0(19x)	1.36	40	1.46	14x14	1.76	1813	2017	320	265	345	295
140-23-9940	4/0(19x)	1.41	40	1.51	18x14	1.82	2053	2258	360	300	395	330
140-23-9941	250(37x)	1.47	40	1.57	14x12	1.90	2314	2877	390	330	425	365
140-23-9942	350(37x)	1.57	40	1.67	18x12	2.00	2818	3182	470	400	510	435
140-23-9943	500(37x)	1.70	55	1.84	18x.0953	2.20	3658	4027	555	470	605	515
140-23-9944	750(61x)	1.90	55	2.03	24x.1010	2.41	4905	5464	650	560	710	620
140-23-9946	1000(61x)	2.02	55	2.18	24x.1167	2.59	6128	6699	815	700	885	770

Okonite's web site, www.okonite.com contains the most up to date information.

(1) individual wire size and count may vary. The resulting combination meets 1/3 or full neutral, size requirement.

Okoguard[®] URO-J

Copper Compact Round Conductor/105°C Rating
(with ICEA S-94-649 Insulation Screen Thickness)**



Product Data Section 2: Sheet 42

Catalog Number	Conductor Size AWG/kcmil	Nominal Dia. over Insulation (in.)	Insulation Screen Thickness (mils)	Nominal Dia. over Insulation Screen (in.)	Copper Neutral No. x AWG (1)	Nominal O.D. (in.)	Approx. Net Weight (lbs./1000')	Approx. Ship Weight (lbs./1000')	90°C Ampacity Direct Burial (2)	90°C Ampacity Duct (2)	105°C Ampacity Direct Burial (2)	105°C Ampacity Duct (2)
15kV - 175 mils (4.45mm), 100% Insulation Level												
Full Neutral												
141-23-2010	2(7x)	0.67	30	0.74	16x14	0.98	718	762	210	160	230	175
141-23-2012	1(19x)	0.70	30	0.77	14x12	1.04	879	950	235	180	260	200
141-23-2014	1/0(19x)	0.74	30	0.81	16x12	1.08	1004	1075	270	205	290	225
141-23-2018	2/0(19x)	0.78	30	0.85	14x10	1.17	1256	1361	310	235	335	255
141-23-2020	3/0(19x)	0.83	30	0.90	16x10	1.21	1449	1599	350	265	380	290
●141-23-2024	4/0(19x)	0.86	24	0.93	18x.1073	1.26	1723	1823	405	305	440	330
1/3 Neutral												
140-23-2010	2(7x)	0.67	30	0.74	6x14	0.98	601	645	195	160	210	175
140-23-2012	1(19x)	0.70	30	0.77	7x14	1.01	682	732	220	180	240	195
140-23-2014	1/0(19x)	0.74	30	0.81	9x14	1.05	792	864	250	200	275	220
140-23-2018	2/0(19x)	0.78	30	0.85	11x14	1.09	922	990	285	230	310	250
140-23-2020	3/0(19x)	0.83	30	0.90	14x14	1.14	1089	1157	325	260	350	285
●140-23-2024	4/0(19x)	0.86	24	0.93	18x14	1.17	1280	1361	365	300	395	325
140-23-2026	250(37x)	0.93	30	1.01	14x12	1.28	1522	1639	395	325	430	355
●140-23-2030	350(37x)	1.01	24	1.08	18x12	1.35	1928	2028	475	390	515	425
●140-23-2032	500(37x)	1.12	24	1.19	18x.0953	1.49	2603	2746	555	455	610	500
●140-23-2036	750(61x)	1.30	24	1.37	24x.1010	1.74	3775	4010	650	545	710	600
140-23-2038	1000(61x)	1.47	40	1.57	24x.1167	1.98	4979	5398	815	685	885	750
15kV - 220 mils (5.59mm), 133% Insulation Level												
Full Neutral												
▲141-23-9460*	2(7x)	0.76	30	0.83	16x14	1.07	792	862	210	160	230	175
●141-23-9060	2(7x)	0.74	24	0.81	16x14	1.05	774	841	210	160	230	175
141-23-9066	1(19x)	0.79	30	0.87	14x12	1.14	960	1022	235	180	260	200
●141-23-9517	1/0(19x)	0.81	24	0.88	16x12	1.15	1065	1145	270	205	290	225
●141-23-9075	2/0(19x)	0.85	24	0.92	14x10	1.23	1320	1405	310	235	335	255
141-23-9533	3/0(19x)	0.92	30	0.99	16x10	1.30	1541	1641	350	265	380	290
●141-23-9535	4/0(19x)	0.95	24	1.02	18x.1073	1.34	1813	1901	405	305	440	330
1/3 Neutral												
●140-23-9512	2(7x)	0.74	24	0.81	6x14	1.05	657	724	195	160	210	175
140-23-9514	1(19x)	0.79	30	0.87	7x14	1.10	761	829	220	180	240	195
●140-23-9523	1/0(19x)	0.81	24	0.88	9x14	1.12	852	933	250	200	275	220
●140-23-9025	2/0(19x)	0.85	24	0.92	11x14	1.16	985	1065	285	230	310	250
140-23-9068	3/0(19x)	0.92	30	0.99	14x14	1.23	1179	1270	325	260	350	285
●140-23-9046	4/0(19x)	0.95	24	1.02	18x14	1.26	1367	1445	365	300	395	325
●140-23-9231	250(37x)	1.00	24	1.07	14x12	1.34	1592	1674	395	325	430	355
●140-23-9234	350(37x)	1.10	24	1.16	18x12	1.43	2030	2173	475	390	515	425
●140-23-9087	500(37x)	1.21	24	1.28	18x.0953	1.58	2720	2906	555	455	610	500
●140-23-9096	750(61x)	1.39	24	1.46	24x.1010	1.83	3913	4197	650	545	710	600
●140-23-9048	1000(61x)	1.54	24	1.60	24x.1167	2.01	5065	5387	815	685	885	750

Okonite's web site, www.okonite.com contains the most up to date information.

▲ Authorized stock item - Available from Customer Service Centers. ● Items use component core for quicker delivery

*141-23-9460 is listed and printed with UL's MV-90 rating on jacket. All other cables shown are available with same listing on special order.

(1) Individual wire size and count may vary. The resulting combination meets 1/3 or full neutral, size requirements.

** When component core is used, insulation screen thickness per ICEA S-93-639 and S-97-682.

Okoguard® URO-J
Copper Compact Round Conductor/105°C Rating
(with ICEA S-94-649 Insulation Screen Thickness)**



Product Data
Section 2: Sheet 42

Catalog Number	Conductor Size AWG/kcmil	Nominal Dia. over Insulation (in.)	Insulation Screen Thickness (mils)	Nominal Dia. over Insulation Screen (in.)	Copper Neutral No. x AWG (1)	Nominal O.D. (in.)	Approx. Net Weight (lbs./1000')	Approx. Ship Weight (lbs./1000')	90°C Ampacity Direct Burial (2)	90°C Ampacity Duct (2)	105°C Ampacity Direct Burial (2)	105°C Ampacity Duct (2)
25kV - 260 mils (6.60mm), 100% Insulation Level												
Full Neutral												
141-23-4166	1(19x)	0.87	30	0.95	14x12	1.22	1040	1129	235	180	260	200
141-23-4172	1/0(19x)	0.91	30	0.99	16x12	1.26	1170	1285	270	205	290	225
141-23-4175	2/0(19x)	0.95	30	1.03	14x10	1.34	1434	1553	310	235	335	255
141-23-4178	3/0(19x)	1.00	30	1.07	16x10	1.39	1634	1787	350	265	380	290
141-23-4181	4/0(19x)	1.05	40	1.15	18x.1073	1.48	1966	2128	405	305	440	330
1/3 Neutral												
140-23-4166	1(19x)	0.87	30	0.95	7x14	1.19	839	952	220	180	240	195
140-23-4172	1/0(19x)	0.91	30	0.99	9x14	1.22	956	1070	250	200	275	220
140-23-4175	2/0(19x)	0.95	30	1.03	11x14	1.26	1092	1206	285	230	310	250
140-23-4178	3/0(19x)	1.00	30	1.07	14x14	1.31	1266	1381	325	260	350	285
140-23-4181	4/0(19x)	1.05	40	1.15	18x14	1.39	1513	1665	365	300	395	325
140-23-4184	250(37x)	1.11	40	1.21	14x12	1.48	1750	1912	395	325	430	355
140-23-4190	350(37x)	1.20	40	1.30	18x12	1.57	2199	2384	475	390	515	425
140-23-4193	500(37x)	1.32	40	1.42	18x.0953	1.78	2969	3197	555	455	610	500
140-23-4197	750(61x)	1.50	40	1.60	24x.1010	1.97	4128	4434	650	545	710	600
140-23-4199	1000(61x)	1.64	55	1.78	24x.1167	2.19	5364	5765	815	685	885	750
35kV - 345 mils (8.76mm), 100% Insulation Level												
Full Neutral												
141-23-9822	1/0(19x)	1.09	40	1.19	16x12	1.46	1404	1544	270	205	290	225
141-23-9825	2/0(19x)	1.13	40	1.23	14x10	1.55	1677	1791	310	235	335	255
141-23-9828	3/0(19x)	1.18	40	1.28	16x10	1.59	1886	2030	350	265	380	290
141-23-9831	4/0(19x)	1.23	40	1.33	18x.1073	1.72	2263	2327	405	305	440	330
1/3 Neutral												
140-23-9822	1/0(19x)	1.09	40	1.19	9x14	1.43	1185	1325	250	200	275	220
140-23-9825	2/0(19x)	1.13	40	1.23	11x14	1.46	1319	1473	285	230	310	250
140-23-9828	3/0(19x)	1.18	40	1.28	14x14	1.52	1512	1655	325	260	350	285
140-23-9831	4/0(19x)	1.23	40	1.33	18x14	1.57	1739	1867	365	300	395	325
140-23-9834	250(37x)	1.28	40	1.38	14x12	1.65	1976	2100	395	325	430	355
140-23-9839	350(37x)	1.37	40	1.47	18x12	1.81	2502	2667	475	390	515	425
●140-23-9841	500(37x)	1.47	24	1.54	18x.0953	1.91	3160	3496	555	455	610	500
140-23-9846	750(61x)	1.67	55	1.80	24x.1010	2.18	4505	4924	650	545	710	600
140-23-9848	1000(61x)	1.81	55	1.95	24x.1167	2.36	5691	6219	815	685	885	750
35kV - 420 mils (10.67mm), 133% Insulation Level												
Full Neutral												
141-23-9922	1/0(19x)	1.25	40	1.35	16x12	1.62	1606	1745	265	210	285	230
141-23-9925	2/0(19x)	1.29	40	1.39	14x10	1.77	1950	2085	305	235	330	255
141-23-9928	3/0(19x)	1.34	40	1.44	16x10	1.81	2168	2332	345	270	375	295
141-23-9931	4/0(19x)	1.39	40	1.49	18x.1073	1.88	2494	2662	395	305	430	330
1/3 Neutral												
140-23-9922	1/0(19x)	1.25	40	1.35	9x14	1.59	1384	1523	250	210	270	230
140-23-9924	2/0(19x)	1.28	40	1.38	11x14	1.68	1576	1677	280	235	305	260
140-23-9927	3/0(19x)	1.34	40	1.44	14x14	1.74	1784	1948	320	265	345	290
140-23-9928	4/0(19x)	1.39	40	1.49	18x14	1.79	2021	2169	360	300	395	330
140-23-9930	250(37x)	1.44	40	1.54	14x12	1.87	2269	2438	390	330	425	365
140-23-9939	350(37x)	1.53	40	1.63	18x12	1.96	2757	3014	470	400	510	435
●140-23-9947	500(37x)	1.62	24	1.69	18x.0953	2.06	3424	3756	555	470	605	515
140-23-9948	750(61x)	1.82	55	1.96	24x.1010	2.34	4801	5380	650	560	710	620
140-23-9949	1000(61x)	1.97	55	2.11	24x.1167	2.51	6011	6547	815	700	885	770

Okonite's web site, www.okonite.com contains the most up to date information.

●Items use component core for quicker delivery.

*141-23-9460 is listed and printed with UL's MV-90 rating on jacket. All other cables shown are available with same listing on special order.

**When component core is used, insulation screen thickness per ICEA S-93-639 and S-97-682.

Okoguard® URO-J

15kV to 35kV Underground Primary Distribution Cable
Jacketed - Red Identification Stripes

Copper Conductor/105°C Rating 100% and 133% Insulation Level



Product Data Section 2: Sheet 42

Table CN Insulation Screen Thickness* per ICEA S-94-649 (for Traditional Concentric Neutral Shield)	
Calculated Minimum Diameter over Insulation (In.)	Minimum Point (mils)
0 - 1.000	30
1.001 - 1.500	40
1.5001 - 2.000	55
2.001 - larger	55

Table CT Insulation Screen Thickness* per ICEA S-93-639 (for Traditional Copper Tape Shield)	
Calculated Minimum Diameter over Insulation (In.)	Minimum Point (mils)
ALL	24

***Insulation Screens:** Two insulation screen thicknesses are available:

Cables with Compressed Round Copper Conductor (Table CN):

Have extruded semiconducting ethylene-propylene rubber insulation screens that meet the requirements of ICEA S-94-649 and AEIC CS8.

Cables with Compact Round Copper Conductor (Table CT):

Have extruded semiconducting ethylene-propylene rubber insulation screens that meet the requirements of ICEA S-93-639/NEMA WC74 & S-97-682, AEIC CS8 and UL 1072, when component core is used.

Okonite's web site, www.okonite.com contains the most up to date information.

Ampacities

(2) Full neutral, single phase ampacities are based on ICEA P-117-734 for 90°C or 105°C conductor temperature, 25°C ambient temperature, 100% load factor, and earth thermal resistivity of RHO 90.

One third neutral ampacities are based on triplexed or triangular configuration for the same conditions stated above.



Okoguard-Okolon[®] TS-CPE Type RHH or RHW-2 or USE-2**, VW-1, FT-4, CSA RW-90

UL 600/1000V and CSA 600V Power and Control

Copper Conductor/90°C Wet or Dry

For Cable Tray Use-Sunlight Resistant-For Direct Burial



A Uncoated, Copper Conductor
B Composite Okoguard/Okolon
TS-CPE Insulation

Composite Insulation

Okoguard-Okolon TS-CPE is Okonite's trade name for its composite insulation system consisting of a layer of EPR and covered with a chlorinated polyethylene (CPE) thermoset compound.

The advantages of Okoguard EPR, with a proven track record of over 50 years as a medium voltage insulation, are now offered in low voltage cables. Okolon TS-CPE is Okonite's trade name for its chlorinated polyethylene (CPE) thermoset compound.

Applications

Okoguard-Okolon TS-CPE 600/1000V Power and Control Cables are recommended for use in all low voltage circuits where continuity of service is the prime consideration. These cables may be installed in wet or dry locations, indoors or outdoors, in raceways, underground ducts, directly buried in the earth, or lashed to a messenger for aerial installation. These cables may also be installed in cable tray (size 1/0 AWG and larger per NEC 392.10(B)(1)).

Specifications

Conductor: Uncoated soft copper per ASTM B-3. Solid per ASTM B-3. Sizes smaller than #8 are compact stranded per ASTM B-8. Sizes #8 and larger are compact stranded per ASTM B-496.

Insulation: Meets or exceeds all requirements of ICEA S-95-658, NEMA WC-70 and UL Standards 44 and 854.

Listed by Underwriters Laboratories, Inc. as Type RHH or RHW-2 or USE-2, VW-1. Sizes 1/0 AWG and larger are also marked sunlight resistant, for use in cable tray.

Listed by CSA as RW-90, -40C, FT1 (1/0 and larger: FT4), sunlight resistant.

** Sizes 12 AWG and larger, with exception to 6 AWG

Product Features

- Sizes 1/0 AWG and larger pass the Vertical Tray Flame Test requirements of UL 1581 for use in cable tray.
- Passes the IEEE 383-1974 Vertical Tray Flame Test. (sizes #6 AWG and larger)
- Passes the IEEE 1202 Vertical Tray Flame Test. (sizes 1/0 AWG & larger)
- Extreme heat resistance; 90°C continuous rating, wet or dry 130°C emergency overload rating 250°C short circuit rating
- Exceptional resistance to deformation at high temperature.
- Stable electrical properties.
- Low SIC and power factor.
- Low moisture absorption.
- Mechanically rugged.
- Resistant to weather, most oils, acids and alkalis.
- More flexible, easier to install and terminate than XLPE insulation.
- UL and CSA Listed.
- Multiple Conductor Constructions Available.

Conductor (AWG/kcmil)	Composite Insulation Thickness (mils)	
	Okoguard	Okolon TS-CPE
14-9	30	15
8	45	15
6-2	45	30
1-4/0	55	45
250-500	65	65
750-1000	80	65

Okoguard-Okolon TS-CPE Type RHH
 or RHW-2 or USE-2**, VW-1, FT-4, CSA RW-90
 UL 600/1000V and CSA 600V Power and Control
 Copper Conductor/90°C Wet or Dry
 For Cable Tray Use - Sunlight Resistant - For Direct Burial

Product Data
Section 3: Sheet 1



Catalog Number	Conductor Size AWG kcmil		Number of Strands	Composite Insulation Thickness - mils		Approx. O.D. - Inches	Approx. O.D. -mm		Approx. Net Weight lbs./1000'		Approx. Ship Weight lbs./1000'		90°C Wet (1) ⁺ NEC Ampacity	75°C Wet (1) ⁺ NEC Ampacity	ICEA Ampacity (2)
112-24-2061	14	1	45	1.14	0.16	4.06	23	28	15	15	24				
▲ 112-24-2071	14	7	45	1.14	0.17	4.57	25	30	15	15	24				
112-24-2091	12	1	45	1.14	0.18	4.57	32	37	20	20	30				
▲ 112-24-2101	12	7	45	1.14	0.19	4.83	34	39	20	20	30				
112-24-2121	10	1	45	1.14	0.20	5.08	46	51	30	30	42				
▲ 112-24-2131	10	7	45	1.14	0.21	5.33	49	54	30	30	42				
112-24-2171	9	19	45	1.14	0.23	5.84	58	63	30	30	48				
▲ 112-24-2191	8	7	60	1.52	0.27	6.86	75	82	55	50	55				
▲ 112-24-2221	6	7	75	1.91	0.33	8.38	119	130	75	65	75				
▲ 112-24-2251	4	7	75	1.91	0.38	9.75	173	184	95	85	97				
▲ 112-24-2311	2	7	75	1.91	0.43	11.00	257	280	130	115	130				
112-24-2331	1	19	100	2.54	0.52	13.16	340	372	150	130	156				
▲ 112-24-2351	1/0	19	100	2.54	0.56	14.10	414	446	170	150	179				
▲ 112-24-2371	2/0	19	100	2.54	0.60	15.14	507	539	195	175	204				
112-24-2391	3/0	19	100	2.54	0.64	16.33	622	654	225	200	242				
▲ 112-24-2411	4/0	19	100	2.54	0.70	17.68	766	805	260	230	278				
▲ 112-24-2431	250	37	130	3.30	0.80	20.32	938	993	290	255	317				
▲ 112-24-2471	350	37	130	3.30	0.89	22.61	1265	1320	350	310	384				
▲ 112-24-2531	500	37	130	3.30	1.01	25.65	1750	1827	430	380	477				
▲ 112-24-2591	750	61	145	3.68	1.21	30.73	2590	2690	535	475	598				
▲ 112-24-2651	1000	61	145	3.68	1.36	34.54	3391	3568	615	545	689				

Okonite's web site, www.okonite.com contains the most up to date information.

▲ **Authorized stock item.** Available from our Customer Service Centers.

(1) **Ampacities** are based on Table 310.16 of the National Electrical Code for these 90°C rated conductors at an ambient temperature of 30°C. The 75°C wet column is provided for additional information.

The ampacities shown apply to open runs of cable, installation in any approved raceway, direct burial in the earth, or as aerial cable on a messenger. Derating for more than three current carrying conductors within a raceway is in accordance with NEC 310.15(C)(1).

(2) Based on three (3) conductors in a single enclosed or exposed conduit. Capacities based on 40°C air ambient using ICEA methods. For 30°C ambient multiply values by 1.10; for 50°C multiply by .90. For other ambients or installation conditions refer to Engineering Data Book EHB.

For ampacities in cable tray, see NEC Section 392.80.

To order a color other than black, change the last digit of the catalog number as follows:			
White	2	Orange	5
Red	3	Blue	6
Green	4	Yellow	7
Example: To order #14/Sol - Red, the catalog number would be 112-24-2063.			

*Current limited to 15, 20 and 30 amps per Section 240.4(D)(3) of the NEC for #14, #12 and #10 AWG, respectively.

**Sizes 12 AWG and larger, with exception to 6 AWG.



Okoguard-Okolon[®] TS-CPE Type RHH or RHW-2, VW-1, FT-4, CSA RW-90

UL and CSA 2kV Power Cable



Copper Conductors/90°C Wet or Dry
For Cable Tray Use - Sunlight Resistant



A Uncoated Copper Conductor
B Composite Okoguard—Okolon TS-CPE Insulation

Composite Insulation

Okoguard-Okolon[®] TS-CPE is Okonite's trade name for its composite insulation system consisting of a layer of EPR and covered with a chlorinated polyethylene (CPE) thermoset compound. The combination of the two materials provides a dielectric which has excellent resistance to heat, mechanical abuse, flame, weathering, most oils, acids and alkalies.

The advantages of Okoguard EPR, with a proven track record of over 50 years as a medium voltage insulation, are now offered in low voltage cables. Okolon TS-CPE is Okonite's trade name for its chlorinated polyethylene (CPE) thermoset compound.

Applications

Okoguard-Okolon TS-CPE 2000 volt power cables are recommended for use in all low voltage circuits where continuity of service is the prime consideration. They can be installed in wet or dry locations, indoors or outdoors in conduit, underground ducts, approved raceways. These cables may also be installed in cable tray (size 1/0 AWG kcmil and larger per NEC 392.10(B)(1)).

Specifications

Conductors: Uncoated soft copper per ASTM B-3. Solid per ASTM B-3. Sizes smaller than #8 are compress stranded per ASTM B-8. Sizes #8 and larger are compact stranded per ASTM B-496.

Composite Insulation: Meets or exceeds all requirements of ICEA S-95-658, NEMA WC-70 and UL Standard 44.

Listed by Underwriters Laboratories, Inc. as Type RHH or RHW-2, VW-1. Sizes 1/0 AWG and larger are also marked sunlight resistant, for use in cable tray. All sizes meet FT-1. Sizes 1/0 and larger meet FT-4.

Listed by CSA as RW-90, -40°C, FT1 (1/0 and larger: FT4), sunlight resistant.

Product Features

- Sizes 1/0 AWG and larger pass the Vertical Tray Flame Test requirements of UL 1581 for use in cable tray.
- Passes the IEEE 383-1974 Vertical Tray Flame Test (size #8 AWG and larger).
- Passes the IEEE 1202 Vertical Tray Flame Test (sizes 1/0 AWG and larger).
- Passes the ICEA T-29-520 (210,000 BTU/hr.) Vertical Tray Flame Test (sizes 2/0 AWG and larger).
- Extreme heat resistance
90°C continuous rating, wet or dry
130°C emergency overload rating
250°C short circuit rating
- Exceptional resistance to deformation at high temperature.
- Stable electrical properties.
- Low SIC and power factor.
- Low moisture absorption.
- Mechanically rugged.
- Resistant to weather, most oils, acids and alkalies.
- Smaller diameter than RHW jacketed cables.
- More flexible, easier to install, terminate or splice than XLPE insulation.
- OSHA acceptable.
- UL and CSA Listed.

Conductor (AWG/kcmil)	Composite Insulation Thickness (mils)	
	Okoguard	Okolon TS-CPE
14-10	45	15
9	55	15
8-2	55	30
1-4/0	65	45
250-500	75	65
750-1000	90	65

Okoguard-Okolon TS-CPE Type RHH or RHW-2, VW-1, FT-4 UL and CSA 2kV Power Cable Copper Conductor/90°C Wet or Dry For Cable Tray Use - Sunlight Resistant



Product Data Section 3: Sheet 10

Catalog Number	Conductor Size AWG or kcmil		Number of Strands	Composite Insulation Thickness - mils	Composite Insulation Thickness - mm	Approx. O.D. - Inches	Approx. O.D. - mm	Approx. Net Weight lbs./1000'	Approx. Ship Weight lbs./1000'	90°C Wet (1)* NEC Ampacity	75°C Wet (1)* NEC Ampacity	ICEA Ampacity (2)
113-24-2061	14	1	60	1.52	0.19	4.83	28	33	15	15	24	
▲ 113-24-2071	14	7	60	1.52	0.20	5.08	30	35	15	15	24	
113-24-2091	12	1	60	1.52	0.21	5.33	38	43	20	20	30	
▲ 113-24-2101	12	7	60	1.52	0.22	5.59	40	45	20	20	30	
113-24-2121	10	1	60	1.52	0.23	5.84	52	57	30	30	42	
▲ 113-24-2131	10	7	60	1.52	0.24	6.10	55	60	30	30	42	
113-24-2171	9	7	70	1.79	0.28	7.11	70	75	30	30	48	
▲ 113-24-2191	8	7	85	2.16	0.32	8.13	90	101	55	50	55	
▲ 113-24-2221	6	7	85	2.16	0.35	8.89	126	137	75	65	75	
▲ 113-24-2251	4	7	85	2.16	0.40	10.26	180	191	95	85	97	
▲ 113-24-2311	2	7	85	2.16	0.45	11.43	265	278	130	115	130	
113-24-2331	1	19	110	2.79	0.54	13.72	348	367	150	130	156	
▲ 113-24-2351	1/0	19	110	2.79	0.57	14.48	424	442	170	150	179	
▲ 113-24-2371	2/0	19	110	2.79	0.61	15.49	517	537	195	175	204	
113-24-2391	3/0	19	110	2.79	0.66	16.76	633	657	225	200	242	
▲ 113-24-2411	4/0	19	110	2.79	0.71	18.03	777	813	260	230	278	
▲ 113-24-2431	250	37	140	3.56	0.83	21.08	957	1004	290	255	317	
▲ 113-24-2471	350	37	140	3.56	0.92	23.37	1286	1355	350	310	384	
▲ 113-24-2531	500	37	140	3.56	1.04	26.42	1773	1915	430	380	477	
▲ 113-24-2591	750	61	155	3.94	1.24	31.50	2618	2805	535	475	598	
113-24-2651	1000	61	155	3.94	1.38	35.05	3423	3674	615	545	689	

Okonite's web site, www.okonite.com contains the most up to date information.

▲ **Authorized stock item.** Available from our Customer Service Centers.

To order a color other than black, change the last digit of the catalog number as follows:			
White	2	Orange	5
Red	3	Blue	6
Green	4	Yellow	7
Example: To order #14 - Red, the catalog number would be 113-24-2073.			

Ampacities

(1) Ampacities are based on Table 310.16 of the National Electrical Code for these 90°C rated conductors at an ambient temperature of 30°C. The 75°C wet column is provided for additional information.

The ampacities shown apply to open runs of cable, installation in any approved raceway, direct burial in the earth, or as aerial cable on a messenger. Derating for more than three current carrying conductors within a raceway is in accordance with NEC 310.15(C)(1).

(2) Based on three (3) conductors in a single enclosed or exposed conduit. Capacities based on 40°C air ambient using ICEA method. For 30°C ambient multiply values by 1.10; for 50°C multiply by 0.89. For other ambients or installation conditions refer to Okonite's Engineering Data Book EHB.

For ampacities in cable tray see NEC Section 392.80.

*Current limited to 15, 20 and 30 amps per Section 240.4(D)(3) of the NEC for #14, #12 and #10 AWG, respectively.



C-L-X[®] Type MC-HL (XHHW-2)

UL 600/1000V and CSA 600V Power MC-HL Cable - Aluminum Sheath
3/C VFD & 4/C Copper Conductors/90°C Wet or Dry Rating
600/1000V Marine Shipboard Cable
For Cable Tray Use - Sunlight Resistant - For Direct Burial

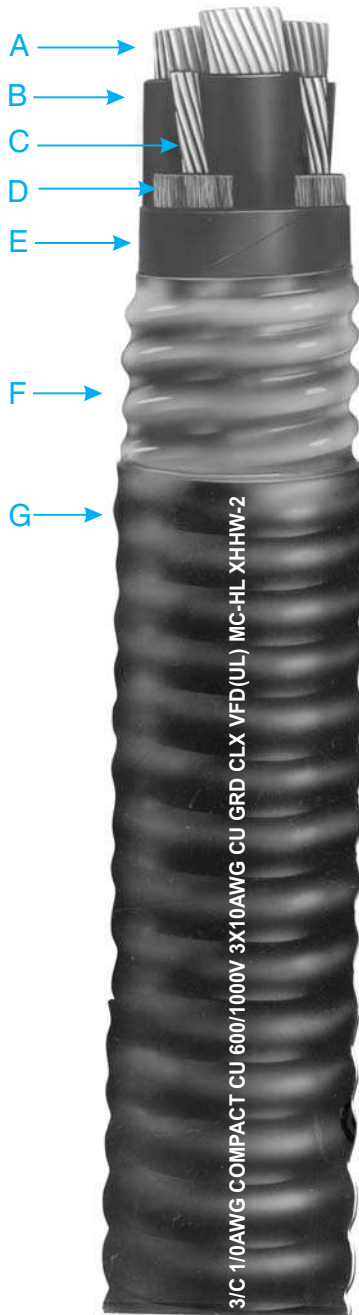

- A Bare, Stranded Copper Conductors
- B X-Olene Insulation-Color Coded for Identification
- C Bare, Stranded Copper Grounding Conductor(s)
- D Non-Hygroscopic Fillers, as necessary
- E Binder Tape
- F Impervious, Continuous, Welded Corrugated, Aluminum C-L-X Sheath
- G Black Okoseal Jacket

Insulation

X-Olene[®] is Okonite's trade name for its chemically cross-linked polyethylene, with high dielectric strength.

Assembly and Coverings

The individual conductors are cabled together with non-hygroscopic fillers and a binder tape overall. The C-L-X sheath exceeds the grounding conductor requirements of Table 250.122 of the NEC and UL 1569. A bare stranded copper grounding conductor(s), located in the outer interstices, is provided for grounding. The impervious, continuous, welded, corrugated aluminum C-L-X sheath provides complete protection against moisture, liquids and gases and has excellent mechanical strength. For direct burial in the ground, embedment in concrete, or for areas subjected to corrosive atmospheres, the C-L-X sheath is protected with a low temperature black Okoseal[®] (PVC) jacket.

Applications

C-L-X Type MC-HL cables with the impervious, continuous, corrugated aluminum sheath are recommended as an economical alternate to a wire in conduit system. In addition, the aluminum CLX sheath exceeds the equipment grounding requirements of NEC Section 250.118 and 250.122, and can be used as the equipment grounding conductor in non-HL areas.

They are authorized for use on services, feeders and branch circuits for power, lighting, control and signaling circuits in accordance with Article 330 and 725 of the NEC.

C-L-X Type MC-HL cables may be installed indoors or outdoors, in wet or dry locations, as open runs of cable secured to supports spaced not more than six feet apart, in cable tray, as aerial cable on a messenger, in any approved raceway, direct burial, or encased in concrete. C-L-X type MC-HL cables are also approved for Classes I, II and III, Division 1 and 2 and Class I, Zones 1 and 2 hazardous locations per NEC Articles 501, 502, 503 and 505; in Zone 1, Zone 2, Class II Div 2, Class III Div 1 and Class III Div 2 per CEC.

Specifications

Conductors: Uncoated soft copper per ASTM B-3. Sizes smaller than #8 are compress stranded per ASTM B-8. Sizes #8 and larger are compact stranded per ASTM B-496.

Insulation: X-Olene per ICEA S-95-658/ NEMA WC70 and UL 44, Listed UL Type XHHW-2. Meets MIL-DTL-1377H, section 4.8.4.1.2 cold bend at -66°C and ASTM D746 brittle point at -76°C.

Conductor Identification: Control Sizes, #9 AWG and smaller, color coded insulation. Power Sizes, #8 AWG and larger, black with printed words of number and color.

Grounding Conductor(s): One or three bare soft copper per ASTM B-3. Stranded in accordance with UL 1581. Meets or exceeds requirements of NEC Table 250.122.

Sheath: Close fitting, impervious, continuous, welded, corrugated aluminum C-L-X per UL 1569. Exceeds grounding conductor requirements of NEC Table 250.122.

Jacket: Black Okoseal (PVC) per UL1569. Meets ASTM D746 brittle point at -40°C.

Product Features

- UL Listed as Type MC-HL cable per UL 2225 (E38916).
- UL Listed for cable tray use, direct burial and sunlight resistant.
- UL 1309 (CWCMC) listed & UL classified in accord with IEEE 1580 as Marine Shipboard Cable rated 600/1000 volts.
- Passes the IEEE 383-1974 and IEEE 1202 Vertical Tray Flame Test.
- Passes the 210,000 BTU ICEAT-29-520 Vertical Tray Flame Test.
- Complete pre-packaged, factory-tested wiring system; color coded.
- C-L-X cables are quality control inspected to meet or exceed applicable UL standards.
- 90°C continuous operating temperature in all types of installations.
- 130°C emergency rating.
- 250°C short circuit rating.
- Good EMI shielding characteristics.
- Impervious, continuous metallic sheath excludes moisture, gases and liquids.
- Lower installed system cost than conduit or EMT systems.
- Provides excellent grounding safety.
- Excellent compression and impact resistance.
- Continuous long lengths.
- Installation temperature of -40°C or °F.
- Complies with NEC Articles 501, 502 and 503 for hazardous locations.
- American Bureau of Shipping Type approved as CWCMC Type MC-HL.
- Three symmetrical grounding conductors with the CLX sheath provide a superior low resistance return path for VFD and other modern ac drive/motor applications.
- CSA C22.2 No. 123 Type RA90.
- CSA C22.2 No. 174 Type HL.
- CSA listed as FT4 and LTGG (-40°C).
- CSA Type RA90 HL complies with CEC Zone 1, Zone 2, Class II Div 2, Class III Div 1 and Class III Div 2 Hazardous Locations.

C-L-X[®] Type MC-HL (XHHW-2)

UL 600/1000V and CSA 600V Power MC-HL Cable - Aluminum Sheath
 3/C VFD & 4/C Copper Conductors/90°C Wet or Dry Rating
600/1000V Marine Shipboard Cable
 For Cable Tray Use - Sunlight Resistant - For Direct Burial



Product Data Section 4: Sheet 1

Catalog Number	Conductor Size AWG	Number of Conductors	Insulation Thickness - mils	Grounding Conductor(s) AWG	Core O.D. - Inches	Core O.D. - mm	C-L-X O.D. - Inches	C-L-X O.D. - mm	Jacket Thickness - mils	Jacket Thickness - mm	Approx. O.D. - Inches	Approx. O.D. - mm	Cross-Sectional Area (sq. In.)†	Approx. Net Weight lbs./1000'	Approx. Net Weight lbs./1000'	90°C Wet or Dry NEC Ampacity*	75°C Wet NEC Ampacity*
▲ 546-31-3403	14(7X)	3	30	3#18	0.33	8.4	0.53	13.5	50	1.27	0.64	16.3	0.32	160	190	15	15
▲ 546-31-3404	(2.08mm ²)	4		3#18	0.37	9.3	0.58	14.7	50	1.27	0.69	17.5	0.37	222	261	15	15
▲ 546-31-3453	12(7X)	3	30	3#16	0.37	9.3	0.58	14.7	50	1.27	0.69	17.5	0.37	239	278	20	20
▲ 546-31-3454	(3.31mm ²)	4		3#16	0.45	11.4	0.67	16.9	50	1.27	0.78	19.7	0.47	286	320	20	20
▲ 546-31-3503	10(7X)	3	30	3#14	0.41	10.4	0.62	15.8	50	1.27	0.73	18.6	0.42	300	380	30	30
▲ 546-31-3504	(5.26mm ²)	4		3#14	0.45	11.4	0.67	16.9	50	1.27	0.78	19.7	0.47	348	428	30	28
▲ 571-31-3190	8(7X)	3	45	3#14	0.50	12.7	0.71	18.0	50	1.27	0.81	20.6	0.52	385	420	55	50
▲ 571-31-3263	(8.36mm ²)	4		10	0.58	14.7	0.80	20.3	50	1.27	0.90	22.9	0.64	465	495	44	40
▲ 571-31-3191	6(7X)	3	45	3#12	0.58	14.7	0.80	20.3	50	1.27	0.90	22.9	0.64	525	595	75	65
▲ 571-31-3270	(13.3mm ²)	4		8	0.66	16.8	0.89	22.5	50	1.27	0.99	25.1	0.77	630	685	60	52
▲ 571-31-3200	4(7X)	3	45	3#12	0.68	17.3	0.89	22.5	50	1.27	0.99	25.1	0.77	704	820	95	85
▲ 571-31-3272	(21.2mm ²)	4		8	0.77	19.6	0.97	24.7	50	1.27	1.08	27.5	0.92	845	930	76	68
▲ 571-31-3204	2(7X)	3	45	3#10	0.80	20.3	1.02	25.9	50	1.27	1.13	28.7	1.00	995	1050	130	115
▲ 571-31-3276	(33.6mm ²)	4		6	0.92	23.4	1.15	29.2	50	1.27	1.26	32.0	1.25	1245	1370	104	92
571-31-3208	1(19X)	3	55	3#10	0.92	23.4	1.15	29.2	50	1.27	1.26	32.0	1.25	1100	1181	145	130
571-31-3280	(42.4mm ²)	4		6	1.04	26.4	1.29	32.8	50	1.27	1.40	35.6	1.54	1500	1620	116	104
▲ 571-31-3213	1/0(19X)	3	55	3#10	1.00	25.5	1.24	31.4	50	1.27	1.34	34.0	1.41	1470	1560	170	150
571-31-3285	(53.5mm ²)	4		6	1.12	28.4	1.37	34.9	50	1.27	1.48	37.6	1.72	1830	1975	136	120
▲ 571-31-3216	2/0(19X)	3	55	3#10	1.09	27.7	1.34	34.0	50	1.27	1.44	36.6	1.63	1770	2020	195	175
▲ 571-31-3289	(67.4mm ²)	4		6	1.23	31.2	1.51	38.5	60	1.52	1.64	41.7	2.11	2310	2545	156	140
▲ 571-31-3218	3/0(19X)	3	55	3#8	1.19	30.2	1.47	37.3	50	1.27	1.58	40.1	1.96	2180	2404	225	200
571-31-3291	(85.1mm ²)	4		6	1.35	34.3	1.64	41.7	60	1.52	1.78	45.2	2.49	2752	2939	180	160
▲ 571-31-3224	4/0(19X)	3	55	3#8	1.33	33.8	1.60	40.6	60	1.52	1.73	44.0	—	2675	2880	260	230
▲ 571-31-3296	(107mm ²)	4		4	1.49	37.8	1.78	45.2	60	1.52	1.91	48.6	—	3430	3710	208	184
▲ 571-31-3228	250(37X)	3	65	3#8	1.48	37.6	1.74	44.2	60	1.52	1.87	47.5	—	3140	3420	290	255
571-31-3300	(127mm ²)	4		4	1.64	41.6	1.96	49.7	60	1.52	2.09	53.0	—	4070	4330	232	204
▲ 571-31-3236	350(37X)	3	65	3#7	1.66	42.2	1.96	49.7	60	1.52	2.09	53.0	—	4210	4300	350	310
▲ 571-31-3308	(177mm ²)	4		3	1.89	48.0	2.19	55.6	75	1.90	2.35	59.8	—	5440	6000	280	248
▲ 571-31-3244	500(37X)	3	65	3#6	1.94	59.3	2.28	57.9	75	1.90	2.44	62.0	—	5930	6420	430	380
▲ 571-31-3316	(253mm ²)	4		2	2.14	54.4	2.49	63.2	75	1.90	2.65	67.4	—	7570	8120	344	304
▲ 571-31-3248	750(61X)	3	80	3#5	2.37	60.2	2.75	69.8	75	1.90	2.92	74.1	—	8700	9400	535	475
571-31-3320	(380mm ²)	4		1	2.61	66.2	3.03	76.9	85	2.16	3.21	81.6	—	11250	12190	428	380
571-31-3252	1000(61X)	3	80	1/0	2.67	67.7	3.11	79.0	85	2.16	3.30	83.8	—	11410	12430	615	545
571-31-3324	(507mm ²)	4		1/0	3.07	78.0	3.63	92.1	85	2.16	3.81	96.8	—	15110	17510	492	436

Okonite's web site, www.okonite.com contains the most up to date information.

C-L-X[®] Type MC-HL (XHHW-2)

UL 600/1000V and CSA 600V Power MC-HL Cable - Aluminum Sheath
 3/C VFD & 4/C Copper Conductors/90°C Wet or Dry Rating
600/1000V Marine Shipboard Cable
 For Cable Tray Use - Sunlight Resistant - For Direct Burial



Product Data Section 4: Sheet 1

600/1000V Composite Power and Control Cable - Aluminum Sheath
Okoseal Jacket: 50 mils (1.27mm)

Catalog Number	Power Conductors Number X Size	Insulation Thickness - mils	Control Conductors Number X Size	Insulating Thickness - mils	Grounding Conductor AWG	C-L-X O.D. - Inches	C-L-X O.D. - mm	Cable O.D. - Inches	Cable O.D. - mm	Cross-Sectional Area (sq. In.)†	Approx. Net Weight lbs./1000'	Approx. Ship Weight lbs./1000'	90°C Wet or Dry NEC Ampacity (1)*	75°C Wet NEC Ampacity*
▲ 546-31-3984	3X10	30	4X12	30	10	0.75	19.0	0.86	21.9	0.58	425	460	30	30
▲ 571-31-3657	3X8	45	4X12	30	10	0.89	22.6	0.99	25.1	0.77	530	585	55	50
▲ 571-31-3667	3X6	45	4X12	30	8	0.93	23.6	1.03	26.2	0.83	655	720	75	65
▲ 571-31-3677	3X4	45	4X12	30	8	0.97	24.7	1.08	27.5	0.92	810	895	95	85

Okonite's web site, www.okonite.com contains the most up to date information.

▲ **Authorized Stock Item.** Available from our Customer Service Centers.
Copper or Bronze C-L-X is available on special order.

Jackets

Optional jacket types available - consult local sales office.

†**Cross-sectional** area for calculation of cable tray fill in accordance with NEC Section 392.22.

(1) Ampacities

Ampacities are based on Table 310.16 of the National Electrical Code for XHHW-2 conductors rated 90°C, in a multi-conductor cable, at an ambient temperature of 30°C (86°F). The 75°C column is provided for additional information.

The ampacities shown apply to open runs of cable, installation in any approved raceway, direct burial in the earth, or as aerial cable on a messenger. Derating for more than three current carrying conductors within the cables is in accordance with NEC Section 310.15(C)(1).

The ampacities shown also apply to cable installed in cable tray in accordance with NEC Section 392.80

*Current limited to 15, 20 and 30 amps per Section 240.4(D)(3) of the NEC for #14, #12 and #10 AWG, respectively.

C-L-X[®] Type MC-HL (XHHW-2)

UL 600/1000V and CSA 600V Power MC-HL Cable - Aluminum Sheath

3/C VFD & 4/C Copper Conductors/90°C Wet or Dry Rating

600/1000V Marine Shipboard Cable

For Cable Tray Use - Sunlight Resistant - For Direct Burial

Product Data Section 4: Sheet 1



Conductor Number	Base Color
1	Black
2	Red
3	Blue
4	Orange

<u>Purpose</u>	<u>Base Color</u>	<u>Tracer Color</u>
Equipment Grounding	Uninsulated Green Green	1 or more continuous yellow stripes
Grounded	White White White White White White White	Black continuous stripe Red continuous stripe Blue continuous stripe Orange continuous stripe Brown continuous stripe Numeric Printing

Sizes 14, 12 & 10 AWG:

Color Coding per ICEA Method 1, E-2 color sequence.

Sizes 8 AWG and larger:

Surface Printing of Numbers and color descriptions per ICEA Method 3, E-2 color sequence.

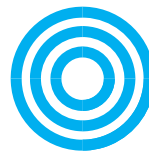

C-L-X[®] Type MC (XHHW-2)

UL 600/1000V and CSA 600V Composite Power Control MC Cable-Aluminum Sheath

Multiple Copper Conductors/90°C Wet or Dry Rating
600/1000V Marine Shipboard Cable

For Cable Tray Use - Sunlight Resistant - For Direct Burial

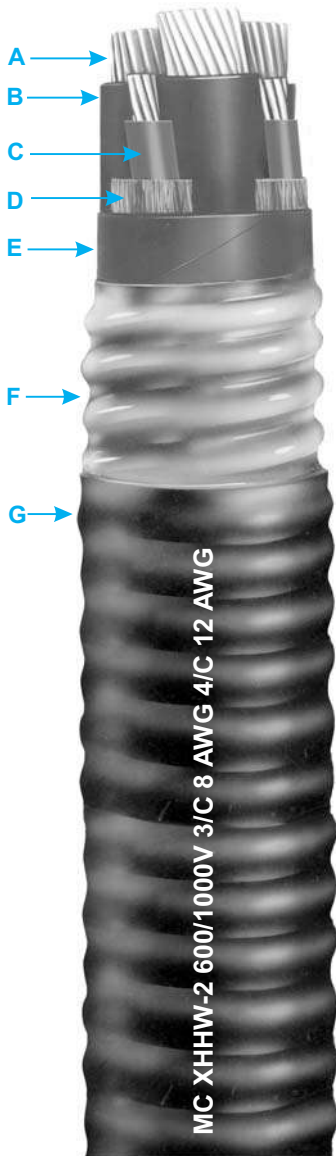

- A Bare, Stranded Copper Power Conductors
- B X-Olene Insulation-Color Coded for Identification
- C Stranded Control Conductors
- D Non-Hygroscopic Fillers, as necessary
- E Binder Tape
- F Impervious, Continuous, Welded Corrugated, Aluminum Sheath
- G Black Okoseal Jacket

Insulation

X-Olene[®] is Okonite's trade name for its chemically cross-linked polyethylene, with high dielectric strength.

Assembly and Coverings

The individual conductors are cabled together with non-hygroscopic fillers, bare copper equipment grounding conductor, where indicated, and a binder tape overall. The C-L-X sheath exceeds the grounding conductor requirements of Table 250.122 of the NEC and UL 1569. The impervious, continuous, welded, corrugated aluminum

C-L-X sheath provides complete protection against moisture, liquids and gases and has excellent mechanical strength. For direct burial in the ground, embedment in concrete, or for areas subjected to corrosive atmospheres, the C-L-X sheath is protected with a low temperature black Okoseal[®] (PVC) jacket.

Applications

C-L-X Type MC cables with the impervious, continuous, corrugated aluminum sheath are recommended as an economical alternate to a wire in conduit system.

They are authorized for use on feeders and branch circuits for power, lighting, control and signaling circuits in accordance with Article 330 and 725 of the NEC.

C-L-X Type MC cables may be installed indoors or outdoors, in wet or dry locations, as open runs of cable secured to supports spaced not more than six feet apart, in cable tray, as aerial cable on a messenger, in any approved raceway, direct burial, or encased in concrete.

C-L-X type MC cables are also approved for use in Class I & II, Division 2, Class III, Divisions 1 and 2 and Class I, Zone 2 hazardous locations per NEC Articles 501, 502, 503 and 505; in Zone 2, Class II Div 2, Class III Div 1 and Class III Div 2 per CEC.

Specifications

Conductors: Uncoated soft copper per ASTM B-3. Sizes smaller than #8 are compressed stranded per ASTM B-8. Sizes #8 and larger are compact stranded per ASTM B-496.

Insulation: X-Olene per ICEA S-95-658/NEMA WC-70, ICEA S-73-532/NEMA WC57, and UL 44, Listed UL Type XHHW-2. Meets MIL-DTL-1377H, section 4.8.4.1.2 cold bond at -66°C and ASTM D746-04 brittle point at -76°C.

Power Conductor Identification: #8 AWG and larger use ICEA Method 3, Table E2, printed numbers and colors (1-Black, 2-Red, 3-Blue, 4-Orange).

Sizes smaller than #8 AWG use ICEA Method 1, Table E2, colored insulation (Black, Red, Blue, Orange).

Control Conductor Identification: All sizes use ICEA Method 1, Table E2, colored insulation (Black, Red, Blue, Orange).

When the control conductors are within one AWG size of the power conductors, the control conductors have an additional tracer to facilitate identification.

Grounding Conductor: Where indicated, bare soft copper per ASTM B-3. Stranded in accordance with UL 1581. Meets or exceeds requirements of NEC Table 250.122.

Sheath: Close fitting, impervious, continuous, welded, corrugated aluminum C-L-X per UL 1569. In addition, the aluminum CLX sheath exceeds the equipment grounding requirements of NEC Section 250.118 and 250.122, and can be used as the equipment grounding conductor.

Jacket: Black Okoseal (PVC) per UL 1569. Meets ASTM D746 brittle point at -40°C.

Product Features

- UL Listed as Type MC cable per E38916.
- UL 1309 (CWCMC) listed & UL classified in accord with IEEE 1580 as Marine Shipboard Cable rated 600/1000 volts.
- UL Listed for cable tray use, direct burial and sunlight resistant.
- Passes the IEEE 383-1974 and IEEE 1202 vertical tray flame tests.
- Passes the 210,000 BTU ICEA T-29-520 Vertical Tray Flame Test.
- Complete pre-packaged, factory-tested wiring system — color coded.
- C-L-X cables are quality control inspected to meet or exceed applicable UL standards.
- 90°C continuous operating temperature in all types of installations.
- 130°C emergency rating.
- 250°C short circuit rating.
- Good EMI shielding characteristics.
- Impervious, continuous metallic sheath excludes moisture, gases and liquids.
- Lower installed system cost than conduit or EMT systems.
- Provides excellent grounding safety.
- Excellent compression and impact resistance.
- Continuous long lengths.
- Installation temperature of -40°C or °F.
- American Bureau of Shipping Type approved as CWCMC Type MC.
- CSA C22.2 No. 123 listed as RA90, FT4 and LTGG (-40°C).
- CSA Type RA90 complies with CEC Zone 2, Class II Div 2, Class III Div 1 and Class III Div 2 Hazardous Locations.

C-L-X[®] Type MC (XHHW-2)

UL 600/1000V and CSA 600V Composite Power

Control MC Cable-Aluminum Sheath

Multiple Copper Conductors/90°C Wet or Dry Rating

600/1000V Marine Shipboard Cable

For Cable Tray Use - Sunlight Resistant - For Direct Burial

X-Olene Insulation: #14 Through #10 AWG, 30 mils (0.76mm); #8 Through #2 AWG, 45 mils (1.14mm)

Okoseal Jacket: 50 mils (1.27mm)

Product Data Section 4: Sheet 2



Catalog Number	Power Conductors Number X Size	Control Conductors Number X Size	Grounding Conductor AWG	C-L-X O.D. - Inches	C-L-X O.D. - mm	Cable O.D. - Inches	Cable O.D. - mm	Cross-Sectional Area (sq. in.)†	Approx. Net Weight lbs./1000'	Approx. Ship Weight lbs./1000'	90°C Wet or Dry NEC Ampacity (1)*	75°C Wet NEC Ampacity*
546-31-3983	3X12	3X14	—	0.71	18.0	0.82	20.8	0.53	304	374	20	20
546-31-3927	3X12	4X14	—	0.71	18.0	0.82	20.8	0.53	320	390	20	20
546-31-3950	4X12	3X14	—	0.71	19.1	0.82	20.8	0.53	328	309	20	20
546-31-3925	4X12	4X14	—	0.75	19.1	0.86	21.8	0.58	281	351	20	20
546-31-3758	3X10	3X14	—	0.75	19.1	0.86	21.8	0.58	358	428	30	20
546-31-3992	3X10	4X14	—	0.80	20.3	0.91	23.1	0.65	388	453	30	30
546-31-3990	3X10	3X12	—	0.75	19.1	0.86	21.8	0.58	296	366	30	30
▲ 546-31-3984	3X10	4X12	10	0.75	19.1	0.86	21.8	0.58	430	465	30	30
546-31-3956	4X10	3X14	—	0.80	20.3	0.91	23.1	0.65	408	473	30	28
546-31-3987	4X10	4X14	—	0.80	20.3	0.91	23.1	0.65	424	489	30	28
546-31-3988	4X10	3X12	—	0.80	20.3	0.91	23.1	0.65	432	497	30	28
546-31-3958	4X10	4X12	—	0.80	20.3	0.91	23.1	0.65	455	520	30	28
571-31-3192	3X8	3X14	—	0.80	20.3	0.91	23.1	0.65	420	500	55	50
571-31-3661	3X8	4X14	—	0.84	21.3	0.95	24.1	0.71	450	530	55	50
571-31-3664	3X8	3X12	—	0.80	20.3	0.91	23.1	0.65	450	530	55	50
571-31-3665	3X8	4X12	—	0.84	21.3	0.95	24.1	0.71	490	570	55	50
▲ 571-31-3657	3X8	4X12	10	0.89	22.6	0.99	25.1	0.77	530	585	55	50
571-31-3682	4X8	3X14	—	0.84	21.3	0.95	24.1	0.71	500	580	44	40
571-31-3960	4X8	4X14	—	0.89	22.6	1.00	25.4	0.79	525	605	44	40
571-31-3683	4X8	3X12	—	0.89	22.6	1.00	25.4	0.79	530	615	44	40
571-31-3680	4X8	4X12	—	0.93	23.6	1.04	26.4	0.85	570	650	44	40
571-31-3686	3X6	3X14	—	0.84	21.3	0.95	24.1	0.71	520	600	75	65
571-31-3666	3X6	4X14	—	0.84	21.3	0.95	24.1	0.71	540	620	75	65
571-31-3673	3X6	3X12	—	0.84	21.3	0.95	24.1	0.71	550	630	75	65
571-31-3668	3X6	4X12	—	0.93	23.6	1.03	26.2	0.83	600	680	75	65
▲ 571-31-3667	3X6	4X12	8	0.93	23.6	1.03	26.2	0.83	655	720	75	65
571-31-3968	4X6	3X14	—	0.93	23.6	1.04	26.4	0.85	650	730	60	52
571-31-3684	4X6	4X14	—	0.93	23.6	1.04	26.4	0.85	660	740	60	52
571-31-3685	4X6	3X12	—	0.97	24.6	1.08	27.4	0.92	680	760	60	52
571-31-3965	4X6	4X12	—	0.97	24.6	1.08	27.4	0.92	710	790	60	52
571-31-3655	3X4	3X14	—	0.93	23.6	1.04	26.4	0.85	700	780	95	85
571-31-3970	3X4	4X14	—	0.93	23.6	1.04	26.4	0.85	720	800	95	85
571-31-3671	3X4	3X12	—	0.93	23.6	1.04	26.4	0.85	720	800	95	85
571-31-3974	3X4	4X12	—	0.97	24.6	1.08	27.4	0.92	760	840	95	85
▲ 571-31-3677	3X4	4X12	8	0.97	24.7	1.08	27.5	0.92	810	895	95	85
571-31-3688	4X4	3X14	—	1.06	26.9	1.17	29.7	1.08	890	970	76	68
571-31-3669	4X4	4X14	—	1.06	26.9	1.17	29.7	1.08	920	1000	76	68
571-31-3670	4X4	3X12	—	1.06	26.9	1.17	29.7	1.08	920	1000	76	68
571-31-3672	4X4	4X12	—	1.06	26.9	1.17	29.7	1.08	950	1030	76	68
571-31-3203	3X2	3X14	—	1.06	26.9	1.17	29.7	1.08	985	1065	130	115
571-31-3674	3X2	4X14	—	1.06	26.9	1.17	29.7	1.08	1000	1080	130	115
571-31-3675	3X2	3X12	—	1.06	26.9	1.17	29.7	1.08	1010	1090	130	115
571-31-3505	3X2	4X12	—	1.06	26.9	1.17	29.7	1.08	1040	1115	130	115
571-31-3506	4X2	3X14	—	1.15	29.2	1.26	32.0	1.25	1230	1320	104	92
571-31-3507	4X2	4X14	—	1.15	29.2	1.26	32.0	1.25	1250	1340	104	92
571-31-3508	4X2	3X12	—	1.15	29.2	1.26	32.0	1.25	1260	1350	104	92
571-31-3509	4X2	4X12	—	1.15	29.2	1.26	32.0	1.25	1280	1370	104	92

▲ **Authorized Stock Item.** Available from our Customer Service Centers.

These stock items are listed as MC-HL Copper or Bronze C-L-X is available on special order.

Jackets

Optional jacket types - consult local sales office.

†**Cross-sectional** area for calculation of cable tray fill in accordance with NEC Section 392.22.

(1) Ampacities

Ampacities are based on Table 310.16 of the National Electrical Code for XHHW-2 conductors rated 90°C, in a multi-conductor cable, at an ambient temperature of 30°C (86°F). The 75°C column is provided for additional information .

The ampacities shown apply to open runs of cable, installation in any approved raceway, direct burial in the earth, or as aerial cable on a messenger.
Derating for more than three current carrying conductors within the cables is in accordance with NEC Section 310.15(C)(1).

The ampacities shown also apply to cable installed in cable tray in accordance with NEC Section 392.80

Okonite's web site, www.okonite.com contains the most up to date information.

*Current limited to 15, 20 and 30 amps per Section 240.4(D) of the NEC for #14, #12 and #10 AWG, respectively.



THE OKONITE COMPANY

Ramsey, New Jersey 07446



Okonite-FMR® Okoseal®

UL Type TC/TC-ER (XHH/XHHW-2) and cUL CIC-TC-ER
600/1000V Power & Control Tray Cable



Multiple Copper Conductors With or Without
Grounding Conductor/90°C Wet or Dry
600/1000V Marine Shipboard Cable

For Cable Tray Use - Sunlight Resistant - For Direct Burial

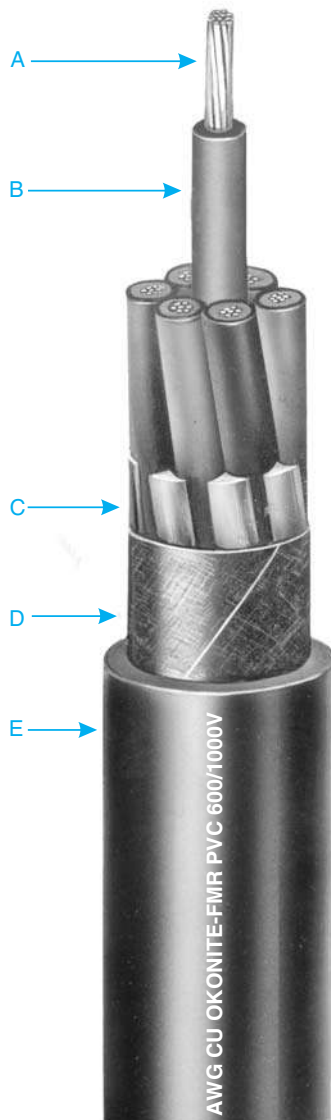

- A Stranded Copper Conductors
- B Okonite-FMR Insulation
- C Fillers, as necessary
- D Binder Tape
- E Okoseal Jacket — Black

Insulation

Okonite-FMR is Okonite's trade name for its heat, moisture, flame and chemical resistant, mechanically rugged ethylene-propylene insulating compound.

The properties of Okonite-FMR insulation substantially enhance the well known features of ethylene-propylene rubber insulations.

Overall Jacket

The Okoseal (PVC) jacket is mechanically rugged and has excellent resistance to most chemicals.

Applications

Okonite-FMR Okoseal Type TC-ER tray cable is permitted for use on power, lighting, control, and signal circuits; indoors or outdoors; in cable trays, raceways, direct burial in the ground, or where supported in outdoor locations by a messenger wire; for Class 1 circuits as permitted in Article 725 of the NEC; and in cable trays in Class I, Division 2 hazardous locations in industrial establishments where the conditions of maintenance and supervision assure that only qualified persons will service the installation. Cables marked TC-ER may also be used between a cable tray and the utilization equipment or device, when installed in accordance with NEC 336.10(7).

As Type Oko-Marine cable, it is suitable for use in marine shipboard and off-shore platform applications in accordance with API and ABS requirements.

Specifications

Conductors: Uncoated soft copper per ASTM B-3. Sizes smaller than #8 are compact stranded per ASTM B-8. Sizes #8 and larger are compact stranded per ASTM B-496.

Insulation: Okonite-FMR meets or exceeds requirements of UL 1581, ICEA S-73-532 (NEMA WC57) and ICEA S-95-658 NEMA WC70 Type II insulation.

Color Coding: Base colors and tracers as shown on reverse of Data Sheet and for sizes #8 AWG and larger black conductors with surface printing of numbers per ICEA S-73-532 NEMA/WC57 Method 4.

Grounding Conductor: Where indicated, bare stranded copper per ASTM B-8, or compact round per ASTM B-496, Class B & NEC Table 250.122.

Assembly: Conductors cabled in accordance with UL 1277 and 1309 using fillers, as necessary, with a cable tape overall.

Overall Jacket: Complies with UL 1277 and 1309. The Okoseal compound meets or exceeds the requirements of UL 1581. UL Listed as Type TC or TC-ER cable with a sunlight resistant low temperature jacket and for direct burial and Type Oko-Marine cable.

Sizes 4 AWG and larger without a grounding conductor are Type TC only (not ER).

Product Features

Insulated conductors are UL rated XHH/XHHW-2, cUL rated RW75/RW90, VW-1, PR I, and -40°C.

90°C continuous rating in wet or dry locations

130°C emergency overload rating

250°C short circuit rating.

Okonite-FMR Okoseal Type TC-ER and Oko-Marine cables are quality control inspected to meet or exceed applicable industry standards.

Resistant to moisture and most chemical atmospheres.

Thermal stability at elevated temperatures.

Flexible, easy to install and terminate.

High dielectric strength.

Installation Temperature -40°C.

Applicable Standards

- UL listed for cable tray use, direct burial, in ducts, and sunlight resistant.
- Vertical Tray Flame Tests; IEEE 383-1974, FT4/IEEE 1202, UL 1277, Sizes 250 kcmil and larger meet ICEA T-29-520 (210,000 BTU/hr).
- OSHA Acceptable
- UL 1309-Oko-Marine
- UL certified to IEEE 1580 - Marine Shipboard Cable rated 600/1000V.
- ABS Type approved; API-RP-14F, IEEE 1202, 46 CFR 111.60.
- CSA C22.2 No. 239 Type CIC for sizes 4/0 AWG and smaller.
- CSA C22.2 No. 230 Type TC-ER for sizes 14 through 4/0 AWG.
- 1000V CSA Type CIC available for sizes 4/0 AWG and smaller.

Okonite-FMR Okoseal®

UL Type TC/TC-ER (XHH/XHHW-2) and cUL CIC-TC-ER 600/1000V Power & Control Tray Cable

Multiple Copper Conductors With or Without
Grounding Conductor/90°C Wet or Dry

600/1000V Marine Shipboard Cable

For Cable Tray Use - Sunlight Resistant - for Direct Burial

Product Data Section 4: Sheet 5



Catalog Number	Conductor Size AWG/kcmil	Number of Conductors	Insulation Thickness (mils)	Grounding Conductor AWG	Jacket Thickness (mils)	Jacket Thickness (mm)	Approx. O.D. (In.)	Approx. O.D. (mm)	Cross-Sectional Area (sq. In.) †	Approx. Net Weight lbs./1000'	Approx. Ship Weight lbs./1000'	90°C Wet or Dry NEC Ampacity (1)*	75°C Wet NEC Ampacity (1)*	
UL TYPE: TC-ER														
▲202-10-3203	14(7X)	3	—	45	1.14	0.40	10.2	0.13	104	127	15	15		
▲202-10-3204		4	—	45	1.14	0.44	11.2	0.16	126	149	15	15		
▲202-10-3205		5	—	45	1.14	0.48	12.2	0.18	151	174	15	15		
▲202-10-3207		7	—	45	1.14	0.52	13.2	0.22	195	218	15	14		
202-10-3209		9	—	60	1.52	0.63	16.0	0.32	260	292	15	14		
▲202-10-3212		12	—	60	1.52	0.71	18.0	0.40	332	364	12	10		
▲202-10-3219		19	—	60	1.52	0.82	20.8	0.54	480	519	12	10		
▲202-10-3237		37	—	80	2.03	1.14	29.0	1.03	925	1005	10	8		
▲202-10-3403		12(7X)	3	—	45	1.14	0.44	11.2	0.16	134	157	20	20	
▲202-10-3443			3	12*	45	1.14	0.48	12.2	0.18	162	185	20	20	
▲202-10-3404			4	—	45	1.14	0.48	12.2	0.19	167	190	20	20	
▲202-10-3405			5	—	45	1.14	0.52	13.2	0.22	202	225	20	20	
▲202-10-3407	7		—	60	1.52	0.60	15.2	0.29	281	305	20	17		
▲202-10-3409	9		—	60	1.52	0.70	17.8	0.39	363	395	20	17		
▲202-10-3412	12		—	60	1.52	0.78	19.8	0.49	446	485	15	12		
▲202-10-3419	19		—	80	2.03	0.95	24.1	0.73	697	752	15	12		
202-10-3437	37		—	80	2.03	1.26	32.0	1.27	1266	1266	12	10		
▲202-10-3503	10(7X)		3	—	45	1.14	0.49	12.4	0.20	183	206	30	30	
▲202-10-3543			3	10*	45	1.14	0.53	13.5	0.23	223	247	30	30	
▲202-10-3504			4	—	60	1.52	0.57	14.5	0.26	243	267	30	28	
202-10-4505		5	—	60	1.52	0.62	15.7	0.31	294	318	30	28		
202-10-3505*		5	—	60	1.52	0.62	15.7	0.31	294	318	30	28		
202-10-3507		7	—	60	1.52	0.67	17.0	0.37	384	416	28	24		
202-10-3509		9	—	60	1.52	0.78	19.8	0.49	494	533	28	24		
202-10-3512		12	—	80	2.03	0.92	23.4	0.68	669	724	20	17		

Okonite's web site, www.okonite.com contains the most up to date information.

▲ Authorized stock item — Available from our Service Centers.

Equipment Grounding Conductor: Any conductor in these cables may be permanently re-identified during installation as the equipment grounding conductor in accordance with Section 250.119(B) of the NEC.

† **Cross-sectional** area for calculation of cable tray fill in accordance with Section 392.22 of the NEC.

* **Method 4 Color Code**

(1) Ampacities

Ampacities are based on Table 310.16 of the National Electrical Code for conductors rated 90°C, in a multi-conductor cable, at an ambient temperature of 30°C (86°F). The 75°C column is provided for additional information.

The ampacities shown apply to open runs of cable, installation in any approved raceway, direct burial in the earth, or as aerial cable on a messenger. Derating for more than three current carrying conductors within the cable is in accordance with NEC Section 310.15(C)(1).

The ampacities shown also apply to cables installed in cable tray in accordance with NEC Section 392.80.

*Current limited to 15, 20 and 30 amps per Section 240.4(D) of the NEC for #14, #12 and #10 AWG, respectively.

Product Data

Section 4: Sheet 5

Catalog Number	Conductor Size AWG/kcmil	UL TC TYPE	Number of Conductors	Insulation Thickness (milis)	Grounding Conductor AWG**	Jacket Thickness (milis)	Jacket Thickness (mm)	Approx. O.D. (In.)	Approx. O.D. (mm)	Cross-Sectional Area (sq. In.) †	Approx. Net Weight lbs./1000'	Approx. Ship Weight lbs./1000'	90°C Wet or Dry NEC Ampacity (1)	75°C Wet NEC Ampacity (1)
112-10-3842	8(7X)	TC-ER	3	45	—	60	1.52	0.64	16.3	0.32	273	305	55	50
▲ 112-10-3844			3		10*	60	1.52	0.70	17.8	0.38	349	388	55	50
112-10-3845			4		—	60	1.52	0.70	17.8	0.38	352	391	45	40
112-10-3847			4		10*	60	1.52	0.73	18.5	0.42	412	451	45	40
112-10-3852	6(7X)	TC-ER	3	45	—	60	1.52	0.72	18.3	0.41	382	421	75	65
▲ 112-10-3854			3		8*	60	1.52	0.76	19.3	0.45	437	469	75	65
112-10-3855			4		—	60	1.52	0.79	20.1	0.49	493	532	60	52
112-10-3857			4		8*	60	1.52	0.83	21.1	0.54	582	637	60	52
112-10-3862	4(7X)	TC	3	45	—	60	1.52	0.81	20.6	0.52	549	588	95	85
▲ 112-10-3864		TC-ER	3		8*	80	2.03	0.84	21.3	0.55	696	751	95	85
112-10-3865		TC	4		—	80	2.03	0.94	23.9	0.69	750	805	76	68
112-10-3867		TC-ER	4		8*	80	2.03	1.00	25.4	0.79	891	955	76	68
112-10-3872	2(7X)	TC	3	45	—	80	2.03	0.99	25.1	0.77	888	952	130	115
▲ 112-10-3874		TC-ER	3		6	80	2.03	0.99	25.1	0.77	941	1005	130	115
112-10-3875		TC	4		—	80	2.03	1.09	27.7	0.93	1133	1200	104	92
112-10-3877		TC-ER	4		6	80	2.03	1.12	28.4	0.99	1242	1322	104	92
112-10-3882	1(19X)	TC	3	55	—	80	2.03	1.10	27.9	0.95	1103	1170	145	130
112-10-3884		TC-ER	3		6	80	2.03	1.10	27.9	0.95	1180	1247	145	130
112-10-3885		TC	4		—	80	2.03	1.21	30.7	1.15	1434	1534	116	104
112-10-3887		TC-ER	4		6	80	2.03	1.21	30.7	1.15	1505	1605	116	104
112-10-3892	1/0(19X)	TC	3	55	—	80	2.03	1.18	30.0	1.09	1330	1410	170	150
▲ 112-10-3894		TC-ER	3		6	80	2.03	1.18	30.0	1.09	1410	1490	170	150
112-10-3895		TC	4		—	80	2.03	1.30	33.0	1.33	1741	1841	136	120
112-10-3897		TC-ER	4		6	80	2.03	1.23	31.2	1.19	1812	1912	136	120
112-10-3902	2/0(19X)	TC	3	55	—	80	2.03	1.27	32.3	1.27	1632	1732	195	175
▲ 112-10-3904		TC-ER	3		6	80	2.03	1.27	32.3	1.27	1711	1811	195	175
112-10-3905		TC	4		—	80	2.03	1.40	35.6	1.54	2114	2230	156	140
112-10-3907		TC-ER	4		6	80	2.03	1.40	35.6	1.54	2186	2302	156	140
112-10-3922	4/0(19X)	TC	3	55	—	80	2.03	1.48	39.4	—	2462	2605	260	230
▲ 112-10-3924		TC-ER	3		4	80	2.03	1.48	39.4	—	2576	2719	260	230
112-10-3925		TC	4		—	80	2.03	1.64	50.0	—	3206	3383	208	184
112-10-3927		TC-ER	4		4	80	2.03	1.64	50.0	—	3320	3497	208	184
112-10-3928	250(37X)	TC	3	65	—	80	2.03	1.62	44.7	—	2904	3047	290	255
112-10-3929		TC-ER	3		4	80	2.03	1.62	44.7	—	3029	3206	290	255
112-10-3930		TC	4		—	110	2.79	1.86	49.3	—	3893	4159	232	204
112-10-3931		TC-ER	4		4	110	2.79	1.86	49.3	—	4000	4265	232	204
112-10-3932	350(37X)	TC	3	65	—	110	2.79	1.89	50.3	—	3995	4261	350	310
▲ 112-10-3933		TC-ER	3		3	110	2.79	1.89	50.3	—	4164	4430	350	310
112-10-3934		TC	4		—	110	2.79	2.08	55.6	—	5243	5590	280	248
112-10-3935		TC-ER	4		3	110	2.79	2.08	55.6	—	5394	5741	280	248
112-10-3936	500(37X)	TC	3	65	—	110	2.79	2.14	57.4	—	5549	5939	430	380
▲ 112-10-3937		TC-ER	3		2	110	2.79	2.14	57.4	—	5743	6133	430	380
112-10-3938		TC	4		—	110	2.79	2.37	63.5	—	7237	7796	344	304
112-10-3939		TC-ER	4		2	110	2.79	2.37	63.5	—	7425	7984	344	304
112-10-3940	750(61X)	TC	3	80	—	110	2.79	2.58	68.6	—	8277	8904	535	475
112-10-3941		TC-ER	3		1	110	2.79	2.58	68.6	—	8515	9142	535	475
112-10-3942		TC	4		—	140	3.56	2.92	76.5	—	10942	11704	428	380
112-10-3943		TC-ER	4		1	140	3.56	2.92	76.5	—	11157	11919	428	380
112-10-3944	1000(61X)	TC	3	80	—	140	3.56	2.96	77.2	—	10953	11715	615	545
112-10-3945		TC-ER	3		1/0	140	3.56	2.96	77.2	—	11237	12000	615	545
112-10-3946		TC	4		—	140	3.56	3.28	85.6	—	14337	15270	492	436
112-10-3947		TC-ER	4		1/0	140	3.56	3.28	85.6	—	14632	15565	492	436

Note: Sizes 4 AWG & larger without a grounding conductor are type TC only (not ER rated).

*Ground size marked with asterisk are green insulated. **Grounds may be split.

Okonite's web site, www.okonite.com contains the most up to date information.

Okonite-FMR Okoseal

UL Type TC/TC-ER (XHH/XHHW-2) and cUL CIC-TC-ER 600/1000V Power & Control Tray Cable

Multiple Copper Conductors With or Without
Grounding Conductor/ 90°C Wet or Dry

600/1000V Marine Shipboard Cable

For Cable Tray Use - Sunlight Resistant - For Direct Burial

Product Data

Section 4: Sheet 5



Conductor Color Coding Sequence Sizes 14, 12 & 10 AWG

Conductor Number	Base Color	Tracer Color
1	Black	
2	Red	
3	Blue	
4	Orange	
5	Yellow	
6	Brown	
7	Red	Black
8	Blue	Black
9	Orange	Black
10	Yellow	Black
11	Brown	Black
12	Black	Red
13	Blue	Red
14	Orange	Red
15	Yellow	Red
16	Brown	Red
17	Black	Blue
18	Red	Blue
19	Orange	Blue
20	Yellow	Blue
21	Brown	Blue
22	Black	Orange
23	Red	Orange
24	Blue	Orange
25	Yellow	Orange
26	Brown	Orange
27	Black	Yellow
28	Red	Yellow
29	Blue	Yellow
30	Orange	Yellow
31	Brown	Yellow
32	Black	Brown
33	Red	Brown
34	Blue	Brown
35	Orange	Brown
36	Yellow	Brown
37	Black	

Color Coding per ICEA Method 1, E-2 (except 202-10-3505 - Method 4)
Sizes 8 AWG and larger:
Surface Printing of Numbers per ICEA Method 4

Special Order: Any or all of the following conductors may be added when specifically requested by the customer to meet their specific application requirements. These conductor codings comply with UL and NEC requirements.

<u>Purpose</u>	<u>Base Color</u>	<u>Tracer Color</u>
Equipment Grounding	Uninsulated Green Green	1 or more continuous yellow stripes
Grounded	White White White White White White	Black continuous stripe Red continuous stripe Blue continuous stripe Orange continuous stripe Brown continuous stripe Numeric Printing

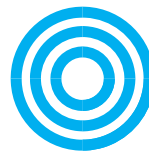

X-Olene®-Okoseal®

UL Type TC/TC-ER (XHH/XHHW-2) and cUL CIC-TC-ER*

600/1000 Volt Power and Control Tray Cable

Multiple Copper Conductors, 90°C Wet or Dry

With or Without Grounding Conductor

For Cable Tray Use - Sunlight Resistant - For Direct Burial

***Sizes 1/0-4/0 AWG**



A Uncoated Copper Conductors
B X-Olene Insulation
C Fillers, as required
D Black Okoseal Jacket

Insulation

X-Olene® is Okonite's trade name for its cross-linked polyethylene, with high dielectric strength insulation.

Jacket

The Okoseal (PVC) jacket supplied with this cable is mechanically rugged and has excellent resistance to acids and most chemicals and is rated for low temperature installations.

Applications

Okonite X-Olene Okoseal tray cable is permitted for use on power, lighting, control, and signal circuits; indoors or outdoors; in cable trays, raceways, direct burial in the ground, or where supported in outdoor locations by a messenger wire; for Class 1 circuits as permitted in Article 725 of the NEC; and in cable trays in Class I, Division 2 hazardous locations in industrial establishments where the conditions of maintenance and supervision assure that only qualified persons will service the installation. Cables marked TC-ER may also be used between a cable tray and the utilization equipment or device, when installed in accordance with NEC 336.10(7).

Specifications

Conductors: Uncoated soft copper per ASTM B-3. Sizes smaller than #8 are compress stranded per ASTM B-8. Sizes #8 and larger are compact stranded per ASTM B-496.

Insulation: X-Olene insulation per UL 1581, listed as XHHW-2.

Color Coding: Base colors and tracers as shown on reverse of Data Sheet and, for sizes #8 AWG and larger, black conductors with surface printing of numbers and colors per ICEA S-73-532 NEMA/WC57 Method 3.

Assembly: Conductors cabled in accordance with UL 1277 using fillers and tape, as needed.

Grounding Conductor: Where indicated, bare or insulated stranded copper in accordance with NEC Table 250.122.

Overall Jacket: Complies with UL 1277. The Okoseal compound meets or exceeds the requirements of UL 1581.

Cable passes the Vertical Tray Flame Test requirements of UL 1277 for Type TC Power and Control Tray Cable.

UL Listed as Type TC or TC-ER cable with a sunlight resistant jacket and for direct burial.

Product Features

Insulated conductors are UL Listed Type XHH / XHHW-2.

90°C continuous rating in wet or dry locations.

130°C emergency overload rating.

250°C short circuit rating.

X-Olene Okoseal Type TC or TC-ER cables are quality control inspected to meet or exceed applicable industry standards.

Resistant to moisture and most chemical atmospheres.

Thermal stability at elevated temperatures.

Easy to install and terminate.

Mechanically rugged.

High dielectric strength.

Small diameter, lightweight.

Minimum installation temperature of -40°C for sizes 2 AWG and larger.

Applicable Standards

- UL listed for cable tray use, direct burial, in ducts, and sunlight resistant.
- Vertical Tray Flame Tests: IEEE 383-1974, Sizes 1/0 AWG and larger meet FT4/IEEE 1202.
- CSA C22.2 No. 239 Type CIC for sizes 2 - 4/0 AWG.
- CSA C22.2 No. 230 Type TC-ER for sizes 1/0 - 4/0 AWG.

X-Olene-Okoseal

UL Type TC/TC-ER (XHH/XHHW-2) and cUL CIC-TC-ER*

600/1000 Volt Power and Control Tray Cable

Multiple Copper Conductors, 90°C Wet or Dry

With or Without Grounding Conductor

For Cable Tray Use - Sunlight Resistant - For Direct Burial

*Sizes 1/0-4/0 AWG

Product Data

Section 4: Sheet 8



Catalog Number	Conductor Size AWG/kcmil	UL TYPE	Number of Conductors	Insulation Thickness mils	Jacket Thickness - mils	Jacket Thickness - mils	Approx. O.D. - mm	Approx. O.D. - Inches	Approx. Cross-Sectional Area (sq. in.)†	Approx. Net Weight lbs./1000'	Approx. Ship Weight lbs./1000'	90°C Wet or Dry NEC Ampacity (1)*	75°C Wet NEC Ampacity (1)*		
▲202-31-3502	14(7X) (2.08mm ²)	TC	2	30 (0.76mm)	45	1.14	0.37	9.4	0.11	70	85	15	15		
▲202-31-3503		TC-ER	3		45	1.14	0.41	10.4	0.13	105	120	15	15		
▲202-31-3504		TC-ER	4		45	1.14	0.43	10.9	0.15	120	135	15	15		
▲202-31-3505		TC-ER	5		45	1.14	0.47	11.9	0.17	132	148	15	15		
▲202-31-3507		TC-ER	7		45	1.14	0.50	12.7	0.20	182	205	15	14		
▲202-31-3509		TC-ER	9		60	1.52	0.62	15.7	0.30	254	278	15	14		
▲202-31-3512		TC-ER	12		60	1.52	0.69	17.6	0.38	306	338	12	10		
202-31-3519		TC-ER	19		60	1.52	0.80	20.3	0.50	446	485	12	10		
202-31-3537		TC-ER	37		80	2.03	1.11	28.2	0.97	856	936	10	8		
▲202-31-3602		12(7X) (3.31mm ²)	TC		2	30 (0.76mm)	45	1.14	0.40	10.2	0.13	92	107	20	20
▲202-31-3603			TC-ER		3		45	1.14	0.44	11.2	0.15	139	152	20	20
▲202-31-3604			TC-ER		4		45	1.14	0.47	11.9	0.17	171	187	20	20
▲202-31-3605	TC-ER		5	45	1.14		0.52	13.1	0.21	179	195	20	20		
▲202-31-3607	TC-ER		7	60	1.52		0.59	15.0	0.27	269	293	20	17		
▲202-31-3609	TC-ER		9	60	1.52		0.68	17.3	0.36	344	376	20	17		
▲202-31-3612	TC-ER		12	60	1.52		0.77	19.6	0.47	425	464	15	12		
202-31-3619	TC-ER		19	80	2.03		0.95	24.1	0.71	640	704	15	12		
202-31-3637	TC-ER		37	80	2.03		1.24	31.5	1.21	1200	1290	12	10		
▲202-31-3702	10(7X) (5.26mm ²)		TC	2	30 (0.76mm)		45	1.14	0.45	11.4	0.16	122	138	30	30
▲202-31-3703			TC-ER	3			45	1.14	0.48	12.2	0.18	183	199	30	30
▲202-31-3704			TC-ER	4			60	1.52	0.56	14.2	0.25	242	258	30	28
▲202-31-3705		TC-ER	5	60		1.52	0.61	15.5	0.29	294	318	30	28		
▲202-31-3707		TC-ER	7	60		1.52	0.66	16.8	0.34	378	410	28	24		
202-31-3709		TC-ER	9	60		1.52	0.77	19.6	0.47	485	524	28	24		
202-31-3712		TC-ER	12	80		2.03	0.91	23.1	0.65	643	698	20	17		

Catalog Number	Conductor Size AWG/kcmil	Number of Conductors	Insulation Thickness mils	Green Insulated Grounding Conductor AWG	Jacket Thickness - mils	Jacket Thickness - mils	Approx. O.D. - mm	Approx. O.D. - Inches	Approx. Cross-Sectional Area (sq. in.)†	Approx. Net Weight lbs./1000'	Approx. Ship Weight lbs./1000'	90°C Wet or Dry NEC Ampacity (1)*	75°C Wet NEC Ampacity (1)*
UL TYPE: TC-ER													
202-31-3813	14(7X)	3	30	1#14	45	1.14	.43	10.9	0.15	120	135	15	15
▲202-31-3823	12(7X)	3	30	1#12	45	1.14	.47	11.9	0.17	171	187	20	20
▲202-31-3833	10(7X)	3	30	1#10	45	1.14	.53	13.5	0.23	238	262	30	30

Catalog Number	Conductor Size AWG/kcmil	Number of Conductors	Insulation Thickness mils	Bare Grounding Conductor AWG	Jacket Thickness - mils	Jacket Thickness - mils	Approx. O.D. - mm	Approx. O.D. - Inches	Approx. Cross-Sectional Area (sq. in.)†	Approx. Net Weight lbs./1000'	Approx. Ship Weight lbs./1000'	90°C Wet or Dry NEC Ampacity (1)*	75°C Wet NEC Ampacity (1)*
UL TYPE: TC													
▲202-31-3653	12(7X)	3	30	1#12	45	1.14	.47	11.9	0.17	141	157	20	20
▲202-31-3753	10(7X)	3	30	1#10	60	1.52	.56	14.2	0.25	214	230	30	30

▲ Authorized Stock Item. Available from our Service Centers.

Equipment Grounding Conductor: Any conductor in TC rated cables may be permanently re-identified during installation as the equipment grounding conductor in accordance with Section 250.119(B) of the NEC.

† Cross-sectional area for calculation of cable tray fill in accordance with NEC Section 392.22.

(1) Ampacities

Ampacities are based on Table 310.16 of the National Electrical Code for XHHW-2 conductors rated 90°C, in a multi-conductor cable, at an ambient temperature of 30°C (86°F). Derating for more than three current carrying conductors within the cable is in accordance with NEC Section 310.15(C)(1). The ampacities shown also apply to cables installed in cable tray in accordance with NEC Section 392.80.

Product Data

Section 4: Sheet 8

Catalog Number	Conductor Size AWG/kcmil	UL TYPE	Number of Conductors	Insulation Thickness - mils	Grounding Conductor AWG	Jacket Thickness - mils	Jacket Thickness - mm	Approx. O.D. - Inches	Approx. O.D. - mm	Approx. Cross-Sectional Area (sq. in.)†	Approx. Net Weight lbs./1000'	Approx. Ship Weight lbs./1000'	90°C Wet or Dry NEC Ampacity (1)	75°C Wet (1) NEC Ampacity
112-31-3734	8(7X) (8.36mm ²)	TC-ER	3	—	60	1.52	0.64	16.3	0.32	259	298	55	50	
▲ 112-31-3735		TC-ER	3	10	60	1.52	0.66	16.7	0.34	313	352	55	50	
112-31-3736		TC-ER	4	45	—	60	1.52	0.70	17.8	0.39	331	370	44	40
112-31-3737		TC-ER	4	45	10	60	1.52	0.72	18.3	0.41	385	424	44	40
112-31-3746	6(7X) (13.3mm ²)	TC-ER	3	—	60	1.52	0.71	18.0	0.40	365	404	75	65	
▲ 112-31-3747		TC-ER	3	8	60	1.52	0.74	18.8	0.43	440	479	75	65	
112-31-3748		TC-ER	4	45	—	60	1.52	0.78	19.8	0.48	471	510	60	52
112-31-3749		TC-ER	4	45	8	60	1.52	0.82	20.8	0.53	552	616	60	52
112-31-3758	4(7X) (21.2mm ²)	TC	3	—	60	1.52	0.81	20.6	0.52	527	566	95	85	
▲ 112-31-3759		TC-ER	3	8	60	1.52	0.81	20.6	0.52	662	715	95	85	
112-31-3760		TC	4	45	—	80	2.03	0.93	23.6	0.68	720	784	76	68
112-31-3761		TC-ER	4	45	8	80	2.03	0.96	24.4	0.72	808	872	76	68
112-31-3764	2(7X) (33.6mm ²)	TC	3	—	80	2.03	0.97	24.6	0.74	816	880	130	115	
▲ 112-31-3765		TC-ER	3	6	80	2.03	0.97	24.6	0.74	1018	1098	130	115	
112-31-3766		TC	4	45	—	80	2.03	1.07	27.2	0.90	1060	1140	104	92
112-31-3767		TC-ER	4	45	6	80	2.03	1.11	28.2	0.97	1196	1276	104	92
112-31-3770	1(19X) (42.4mm ²)	TC	3	—	80	2.03	1.09	27.7	0.93	1051	1118	145	130	
112-31-3771		TC-ER	3	6	80	2.03	1.09	27.7	0.93	1127	1194	145	130	
112-31-3772		TC	4	55	—	80	2.03	1.20	30.5	1.13	1355	1435	116	104
112-31-3773		TC-ER	4	55	6	80	2.03	1.20	30.5	1.13	1431	1511	116	104
112-31-3776	1/0(19X) (53.5mm ²)	TC	3	—	80	2.03	1.17	29.7	1.08	1274	1354	170	150	
▲ 112-31-3777		TC-ER	3	6	80	2.03	1.17	29.7	1.08	1350	1430	170	150	
112-31-3778		TC	4	55	—	80	2.03	1.29	32.8	1.31	1652	1752	136	120
112-31-3779		TC-ER	4	55	6	80	2.03	1.29	32.8	1.31	1729	1829	136	120
112-31-3780	2/0(19X) (67.4mm ²)	TC	3	—	80	2.03	1.26	32.0	1.25	1561	1661	195	175	
▲ 112-31-3781		TC-ER	3	6	80	2.03	1.26	32.0	1.25	1639	1739	195	175	
112-31-3782		TC	4	55	—	80	2.03	1.39	35.3	1.52	2033	2149	156	140
112-31-3783		TC-ER	4	55	6	80	2.03	1.39	35.3	1.52	2109	2225	156	140
112-31-3784	4/0(19X) (107mm ²)	TC	3	—	80	2.03	1.47	37.3	—	2361	2504	260	230	
▲ 112-31-3785		TC-ER	3	4	80	2.03	1.47	37.3	—	2488	2631	260	230	
112-31-3786		TC	4	55	—	80	2.03	1.63	41.4	—	3101	3278	208	184
112-31-3787		TC-ER	4	55	4	80	2.03	1.63	41.4	—	3222	3399	208	184
112-31-3788	250(37X) (127mm ²)	TC	3	—	80	2.03	1.62	41.2	—	2796	2939	290	255	
112-31-3789		TC-ER	3	4	80	2.03	1.62	41.2	—	2917	3060	290	255	
112-31-3790		TC	4	65	—	110	2.79	1.85	47.0	—	3778	4044	232	204
112-31-3791		TC-ER	4	65	4	110	2.79	1.85	47.0	—	3899	4165	232	204
112-31-3792	350(37X) (177mm ²)	TC	3	—	110	2.79	1.88	47.8	—	3889	4155	350	310	
▲ 112-31-3793		TC-ER	3	3	110	2.79	1.88	47.8	—	4044	4310	350	310	
112-31-3794		TC	4	65	—	110	2.79	2.08	52.8	—	5091	5438	280	248
112-31-3795		TC-ER	4	65	3	110	2.79	2.08	52.8	—	5245	5592	280	248
112-31-3796	500(37X) (253mm ²)	TC	3	—	110	2.79	2.13	54.1	—	5386	5733	430	380	
▲ 112-31-3797		TC-ER	3	2	110	2.79	2.13	54.1	—	5581	5928	430	380	
112-31-3798		TC	4	65	—	110	2.79	2.36	59.9	—	7082	7641	344	304
112-31-3799		TC-ER	4	65	2	110	2.79	2.36	59.9	—	7276	7835	344	304
112-31-3800	750(61X) (380mm ²)	TC	3	—	110	2.79	2.56	65.0	—	7961	8520	535	475	
▲ 112-31-3801		TC-ER	3	1	110	2.79	2.56	65.0	—	8206	8833	535	475	
112-31-3802		TC	4	80	—	140	3.56	2.90	73.7	—	10632	11394	428	380
112-31-3803		TC-ER	4	80	1	140	3.56	2.90	73.7	—	10879	11641	428	380
112-31-3804	1000(61X) (507mm ²)	TC	3	—	140	3.56	2.93	74.4	—	10584	11346	615	545	
112-31-3805		TC-ER	3	1/0	140	3.56	2.93	74.4	—	10894	11656	615	545	
112-31-3806		TC	4	80	—	140	3.56	3.25	82.6	—	13925	14858	492	436
112-31-3807		TC-ER	4	80	1/0	140	3.56	3.25	82.6	—	14235	15168	492	436

NOTE: Sizes 4 AWG & larger without a grounding conductor are Type TC only (Not ER rated).

X-Olene-Okoseal

UL Type TC/TC-ER (XHH/XHHW-2) and cUL CIC-TC-ER*

600/1000 Volt Power and Control Tray Cable

Multiple Copper Conductors, 90°C Wet or Dry

With or Without Grounding Conductor

For Cable Tray Use - Sunlight Resistant - For Direct Burial

*Sizes 1/0-4/0 AWG

Product Data

Section 4: Sheet 8



Conductor Color Coding Sequence

Ungrounded Conductor Number	Base Color	Tracer Color
1	Black	
2	Red	
3	Blue	
4	Orange	
5	Yellow	
6	Brown	
7	Red	Black
8	Blue	Black
9	Orange	Black
10	Yellow	Black
11	Brown	Black
12	Black	Red
13	Blue	Red
14	Orange	Red
15	Yellow	Red
16	Brown	Red
17	Black	Blue
18	Red	Blue
19	Orange	Blue
20	Yellow	Blue
21	Brown	Blue
22	Black	Orange
23	Red	Orange
24	Blue	Orange
25	Yellow	Orange
26	Brown	Orange
27	Black	Yellow
28	Red	Yellow
29	Blue	Yellow
30	Orange	Yellow
31	Brown	Yellow
32	Black	Brown
33	Red	Brown
34	Blue	Brown
35	Orange	Brown
36	Yellow	Brown
37	Black	

Color Coding

Sizes 14, 12 & 10 AWG:
per ICEA Method 1, E-2 color sequence

Sizes 8 AWG and larger:
Surface Printing of Numbers and color
designation per ICEA Method 3, E-2
color sequence

Special Order: Any or all of the following conductors may be added when specifically requested by the customer to meet their specific application requirements. These conductor codings comply with UL and NEC requirements.

<u>Purpose</u>	<u>Base Color</u>	<u>Tracer Color</u>
Equipment Grounding	Uninsulated Green Green	1 or more continuous yellow stripes
Grounded	White White White White White White White	Black continuous stripe Red continuous stripe Blue continuous stripe Orange continuous stripe Brown continuous stripe Numeric Printing

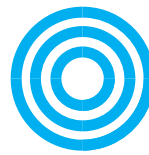

C-L-X[®] Type MC (XHHW-2)

UL 600/1000V and CSA 600V Control Cable - Aluminum Sheath

Multiple Copper Conductors/90°C Wet or Dry Rating

600/1000V Marine Shipboard Cable

For Cable Tray Use - Sunlight Resistant - For Direct Burial

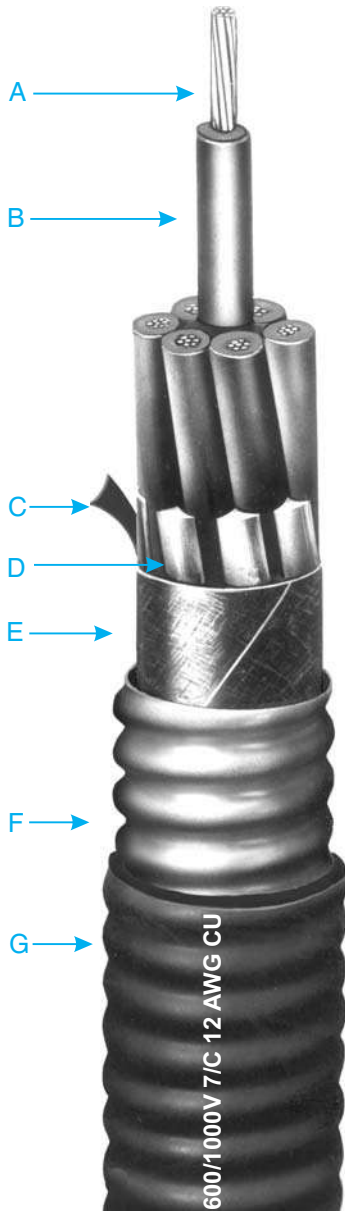

- A Bare, Stranded Copper Conductors
- B X-Olene Insulation-Color Coded for Identification
- C Marker Tape
- D Non-Hygroscopic Fillers, as necessary
- E Binder Tape
- F Impervious, Continuous, Corrugated, Aluminum C-L-X Sheath
- G Black Okoseal Jacket

Insulation

X-Olene[®] is Okonite's trade name for its chemically cross-linked polyethylene, with high dielectric strength.

Color Coding

Conductors are color coded using base colors and tracers in accordance with the Conductor Identification Table on the back of this Data Sheet.

Assembly and Coverings

The individual conductors are cabled together with non-hygroscopic fillers and a binder tape overall. The C-L-X sheath exceeds the grounding conductor requirements of Table 250.122 of the NEC and UL 1569.

The impervious, continuous, corrugated aluminum C-L-X sheath provides complete protection against moisture, liquids and gases and has excellent mechanical strength. For direct burial in the ground, embedment in concrete, or for areas subjected to corrosive atmospheres, the C-L-X sheath is protected with a low temperature black Okoseal[®] (PVC) jacket.

Applications

C-L-X Type MC cables with the impervious, continuous, corrugated aluminum sheath are recommended as an economical alternate to a wire in conduit system.

They are authorized for use on services, feeders and branch circuits for power, lighting, control and signaling circuits in accordance with Articles 330 and 725 of the NEC.

C-L-X Type MC cables may be installed indoors or outdoors, in wet or dry locations, as open runs of cable secured to supports spaced not more than six feet apart, in cable tray, as aerial cable on a messenger, in any approved raceway, direct burial, or encased in concrete. C-L-X Type MC cables are also approved for use in Class I & II, Division 2, Class III, Divisions 1 and 2, and Class I, Zone 2 hazardous locations per NEC articles 501, 502, 503 and 505; in Zone 2, Class II Div 2, Class III Div 1 and Class III Div 2 per CEC.

Specifications

Conductors: Bare soft annealed copper, Class B stranding per ASTM B-8.

Insulation: X-Olene per ICEA S-73-532/ NEMA WC57 and UL 44, Listed UL Type XHHW-2. Meets MIL-DTL-1377H, section 4.8.4.1.2 cold bend at -66°C and ASTM D746-04 brittle point at -76°C.

Conductor Identification: Base Colors and tracers.

Assembly: Per UL 1569 with binder tape overall.

Sheath: Close fitting, impervious, continuous, corrugated aluminum C-L-X per UL 1569.

In addition, the aluminum CLX sheath exceeds the equipment grounding requirements of NEC Section 250.118 and 250.122, and can be used as the equipment grounding conductor.

Jacket: Black Okoseal (PVC) per UL requirements for Type MC Cables. Meets ASTM D746-04 brittle point at -40°C.

Product Features

- UL Listed as Type MC cable and Marine Shipboard Cable, E38916 (UL 1569) and E137931 (UL 1309).
- UL Listed for cable tray use, direct burial and sunlight resistant.
- UL 1309 (CWCMC) listed & UL classified in accord with IEEE 1580 as Marine Shipboard Cable rated 600/1000 volts.
- Passes the IEEE 383-1974 and IEEE 1202/FT4 vertical tray flame tests.
- Passes the 210,000 BTU/hr ICEA T-29-520 Vertical Tray Flame Test.
- Complete pre-packaged, factory-tested wiring system — color coded.
- C-L-X cables are quality control inspected to meet or exceed applicable UL standards.
- 90°C continuous operating temperature in all types of installations
- 130°C emergency rating
- 250°C short circuit rating.
- Good EMI shielding characteristics.
- Impervious, continuous metallic sheath excludes moisture, gases and liquids.
- Lower installed system cost than conduit or EMT systems.
- Provides excellent grounding safety
- Excellent compression and impact resistance.
- Continuous long lengths.
- Installation temperature of -40°C or °F.
- UL and American Bureau of Shipping Type approved as CWCMC Type MC.
- CSA C22.2 No. 123 listed as RA90, FT4 and LTGG (-40°C).
- CSA Type RA90 complies with CEC Zone 2, Class II Div 2, Class III Div 1, Class III Div 2 Hazardous Locations.

C-L-X[®] Type MC (XHHW-2)

UL 600/1000V and CSA 600V Control Cable - Aluminum Sheath

Multiple Copper Conductors/90°C Wet or Dry Rating

600/1000V Marine Shipboard Cable

For Cable Tray Use - Sunlight Resistant - For Direct Burial



Product Data Section 4: Sheet 14

Catalog Number	Conduct Size AWG	Number of Conductors	Insulation Thickness - mils	Core O.D. - Inches	Core O.D. - mm	C-L-X O.D. - Inches	C-L-X O.D. - mm	Jacket Thickness - mils	Jacket Thickness - mm	Approx. O.D. - Inches	Approx. O.D. - mm	Cross-Sectional Area (sq. in.)†	Approx. Net Weight lbs./1000'	Approx. Ship Weight lbs./1000'	90°C Wet or Dry (1) NEC Ampacity	75°C Wet NEC Ampacity*
▲ 546-31-3002	14(7X) (2.08mm ²)	2	30 (0.76mm)	0.28	7.1	0.49	12.3	50	1.27	0.60	15.1	0.28	142	174	15	15
▲ 546-31-3003		3		0.30	7.6	0.49	12.4					0.32	153	185	15	15
▲ 546-31-3004		4		0.33	8.4	0.53	13.5					0.36	181	214	15	15
▲ 546-31-3005		5		0.37	9.4	0.58	14.7					0.41	210	242	15	15
▲ 546-31-3007		7		0.41	10.4	0.62	15.7					0.46	254	309	15	14
▲ 546-31-3009		9		0.50	12.7	0.71	18.0					0.57	308	363	15	14
▲ 546-31-3012		12		0.57	14.4	0.80	20.3					0.71	381	448	12	10
▲ 546-31-3019		19		0.69	17.5	0.93	23.6					0.84	537	604	12	10
▲ 546-31-3037		37		0.96	24.4	1.24	31.5					1.43	946	1036	10	8
546-31-3082	12(7X) (3.31mm ²)	2	30 (0.76mm)	0.31	7.8	0.53	13.5	50	1.27	0.64	16.3	0.32	164	196	20	20
▲ 546-31-3083		3		0.34	8.6	0.53	13.5					0.32	189	221	20	20
▲ 546-31-3084		4		0.38	9.6	0.58	14.7					0.38	226	258	20	20
▲ 546-31-3085		5		0.42	10.6	0.62	15.7					0.42	262	317	20	20
▲ 546-31-3087		7		0.47	11.9	0.67	17.0					0.48	324	379	20	17
▲ 546-31-3089		9		0.56	14.2	0.80	20.3					0.65	405	472	20	17
▲ 546-31-3092		12		0.65	16.5	0.89	22.6					0.79	503	570	15	12
▲ 546-31-3099		19		0.78	19.8	1.02	25.9					1.00	721	801	15	12
▲ 546-31-3117		37		1.08	27.4	1.37	34.8					1.72	1301	1444	12	10
▲ 546-31-3162	10(7X) (5.26mm ²)	2	30 (0.76mm)	0.36	9.1	0.58	14.7	50	1.27	0.69	17.5	0.38	202	234	30	30
▲ 546-31-3163		3		0.39	9.9	0.58	14.7					0.38	238	270	30	30
▲ 546-31-3164		4		0.44	11.1	0.67	17.0					0.48	297	352	30	28
546-31-3165		5		0.48	12.2	0.71	18.0					0.53	348	403	30	28
▲ 546-31-3167		7		0.54	13.7	0.75	19.1					0.58	436	491	28	24
546-31-3169		9		0.65	16.5	0.89	22.6					0.79	544	611	28	24
546-31-3172		12		0.74	18.8	0.97	24.6					0.85	684	751	20	17

Okonite's web site, www.okonite.com contains the most up to date information.

▲ **Authorized Stock Item.** Available from our Customer Service Centers.

Copper or Bronze C-L-X - is available on special order.

†**Cross-sectional** area for calculation of cable tray fill in accordance with NEC Section 392.22.

Jackets - Optional jacket types available - consult local sales office.

(1) Ampacities

Ampacities are based on Table 310.16 of the National Electrical Code for XHHW-2 conductors rated 90°C, in a multi-conductor cable, at an ambient temperature of 30°C (86°F). The 75°C column is provided for additional information.

The ampacities shown apply to open runs of cable, installation in any approved raceway, direct burial in the earth, or as aerial cable on a messenger. Derating for more than three current carrying conductors within the cable is in accordance with NEC Section 310.15(C)(1).

The ampacities shown also apply to cables installed in cable tray in accordance with NEC Section 392.80.

*Current limited to 15, 20 and 30 amps per Section 240.4(D) of the NEC for #14, #12 and #10 AWG, respectively.

C-L-X[®] Type MC (XHHW-2)

UL 600/1000V and CSA 600V Control Cable - Aluminum Sheath

Multiple Copper Conductors/90°C Wet or Dry Rating

600/1000V Marine Shipboard Cable

For Cable Tray Use - Sunlight Resistant - For Direct Burial



Product Data Section 4: Sheet 14

Conductor Color Coding Sequence

Conductor Number	Base Color	Tracer Color
1	Black	
2	Red	
3	Blue	
4	Orange	
5	Yellow	
6	Brown	
7	Red	Black
8	Blue	Black
9	Orange	Black
10	Yellow	Black
11	Brown	Black
12	Black	Red
13	Blue	Red
14	Orange	Red
15	Yellow	Red
16	Brown	Red
17	Black	Blue
18	Red	Blue
19	Orange	Blue
20	Yellow	Blue
21	Brown	Blue
22	Black	Orange
23	Red	Orange
24	Blue	Orange
25	Yellow	Orange
26	Brown	Orange
27	Black	Yellow
28	Red	Yellow
29	Blue	Yellow
30	Orange	Yellow
31	Brown	Yellow
32	Black	Brown
33	Red	Brown
34	Blue	Brown
35	Orange	Brown
36	Yellow	Brown
37	Black	

Color Coding per ICEA Method 1, E-2

Special Order: Any or all of the following conductors may be added when specifically requested by the customer to meet their specific application requirements. These conductor codings comply with UL and NEC requirements.

<u>Purpose</u>	<u>Base Color</u>	<u>Tracer Color</u>
Equipment Grounding	Uninsulated Green Green	1 or more continuous yellow stripes
Grounded	White	Black continuous stripe
	White	Red continuous stripe
	White	Blue continuous stripe
	White	Orange continuous stripe
	White	Brown continuous stripe
	White	Numeric printing

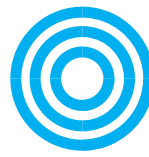

C-L-X[®] Type MC-HL (XHHW-2)

UL 600/1000V and CSA 600V Control Cable - Aluminum Sheath

Multiple Copper Conductors/90°C Wet or Dry Rating

600/1000V Marine Shipboard Cable

For Cable Tray Use - Sunlight Resistant - For Direct Burial

Insulation

X-Olene[®] is Okonite's trade name for its chemically cross-linked polyethylene, with high dielectric strength.

Color Coding

Conductors are color coded using base colors and tracers in accordance with the Conductor Identification Table on the back of this Data Sheet.

Assembly and Coverings

The individual conductors are cabled together with non-hygroscopic fillers and a binder tape overall. The C-L-X sheath exceeds the grounding conductor requirements of Table 250.122 of the NEC and UL1569.

The impervious, continuous, corrugated aluminum C-L-X sheath provides complete protection against moisture, liquids and gases and has excellent mechanical strength. For direct burial in the ground, embedment in concrete, or for areas subjected to corrosive atmospheres, the C-L-X sheath is protected with a low temperature black Okoseal[®] (PVC) jacket.

Applications

C-L-X Type MC cables with the impervious, continuous, corrugated aluminum sheath are recommended as an economical alternate to a wire in conduit system. In addition, the aluminum CLX sheath exceeds the equipment grounding requirements of NEC Section 250.118 and 250.122, and can be used as the equipment grounding conductor in non-HL areas.

They are authorized for use on services, feeders and branch circuits for power, lighting, control and signaling circuits in accordance with Articles 330 and 725 of the NEC.

C-L-X Type MC-HL cables may be installed indoors or outdoors, in wet or dry locations, as open runs of cable secured to supports spaced not more than six feet apart, in cable tray, as aerial cable on a messenger, in any approved raceway, direct burial, or encased in concrete. C-L-X Type MC-HL cables are also approved for Classes I, II, and III Division 1 and 2 and Class I, Zones 1 and 2 hazardous locations per NEC Articles 501, 502, and 503 and UL 2225; in Zone Class II Div 2, Class III Div 1 and Class III Div 2 per CEC.

Specifications

Conductors: Bare soft annealed copper, Class B stranding per ASTM B-8.

Insulation: X-Olene per ICEA S-73-532 and UL 44, Listed UL Type XHHW-2. Meets MIL-DTL-1377H, section 4.8.4.1.2, cold bend at -66°C and ASTM D746-04 brittle point at -40°C.

Conductor Identification: Base Colors and tracers.

Grounding Conductor: Green insulated stranded copper per ASTM B-8, Class B. Meets or exceeds requirements of NEC Table 250.122.

Assembly: Per UL 1569 with binder tape overall.

Sheath: Close fitting, impervious, continuous, corrugated aluminum C-L-X per UL 1569. Exceeds grounding conductor requirements of NEC Table 250.122.

Jacket: Black Okoseal (PVC) per UL requirements for Type MC-HL Cables. Meets ASTM D746-04 brittle point at -40°C.

Product Features

- UL Listed as Type MC-HL cable and Marine Shipboard Cable, E38916 (UL 1569) and E137931 (UL1309).
- UL Listed for cable tray use, direct burial and sunlight resistant.
- UL 1309 listed (CWCMC) & UL classified in accord with IEEE 1580 as Marine Shipboard Cable rated 600/1000V.
- Passes the IEEE 383-1974 and IEEE 1202/FT4 vertical tray flame tests.
- Passes the 210,000 BTU/hr ICEA T-29-520 Vertical Tray Flame Test.
- Complete pre-packaged, factory-tested wiring system — color coded.
- C-L-X cables are quality control inspected to meet or exceed applicable UL standards.
- 90°C continuous operating temperature in all types of installations.
- 130°C emergency rating.
- 250°C short circuit rating.
- Good EMI shielding characteristics.
- Impervious, continuous metallic sheath excludes moisture, gasses and liquids.
- Lower installed system cost than conduit or EMT systems.
- Provides excellent grounding safety.
- Excellent compression and impact resistance.
- Continuous long lengths.
- Installation temperature of -40°C or °F.
- Complies with NEC Articles 501, 502 and 503 for hazardous locations.
- UL and American Bureau of Shipping listed as CWCMC Type MC-HL.
- CSA C22.2 No. 123 Type RA90.
- CSA C22.2 No. 174 Type HL.
- CSA listed as FT4 and LTGG (-40°C).
- CSA Type RA 90-HL complies with CEC Zone 1, Zone 2, Class II Div 2, Class III Div 1 and Class III Div 2 Hazardous Locations.

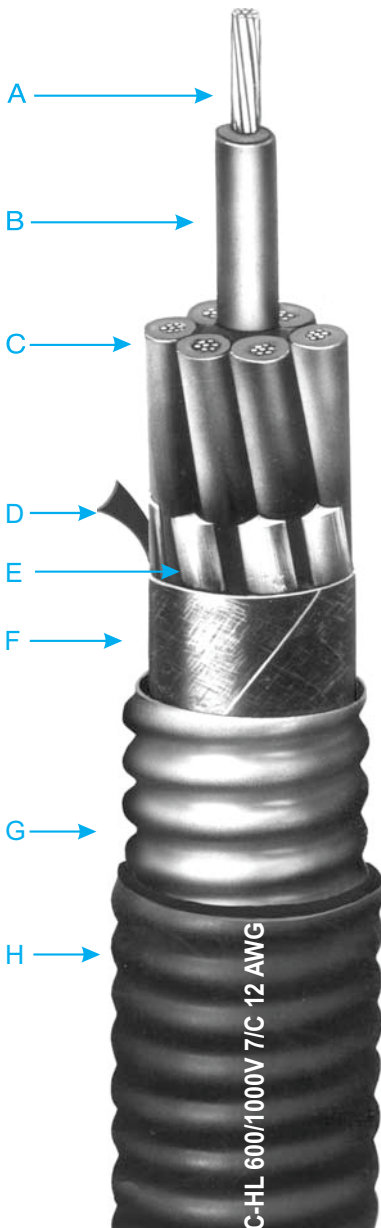

- A Bare, Stranded Copper Conductors
- B X-Olene Insulation-Color Coded for Identification
- C Stranded copper, green insulated grounding conductor
- D Marker Tape
- E Non-Hygroscopic Fillers, as necessary
- F Binder Tape
- G Impervious, Continuous, Corrugated, Aluminum C-L-X Sheath
- H Black Okoseal Jacket

C-L-X[®] Type MC-HL (XHHW-2)

UL 600/1000V and CSA 600V Control Cable - Aluminum Sheath

Multiple Copper Conductors/90°C Wet or Dry Rating

600/1000V Marine Shipboard Cable

For Cable Tray Use - Sunlight Resistant - For Direct Burial



Product Data Section 4: Sheet 15

Catalog Number	Conductor Size AWG	Number of Ungrounded Green Insulated Grounding Conductor AWG	Core O.D. - Inches	Core O.D. - mm	C-L-X O.D. - Inches	C-L-X O.D. - mm	Jacket Thickness - mils	Jacket Thickness - mm	Approx. O.D. - Inches	Approx. O.D. - mm	Cross-Sectional Area (sq. in.)†	Approx. Net Weight lbs./1000	Approx. Ship Weight lbs./1000	90°C Wet or Dry (1) NEC Ampacity	75°C Wet NEC Ampacity*
▲ 546-31-3402 ▲ 546-31-3406 ▲ 546-31-3408	14(7X) (2.08mm ²)	2	0.30	7.6	0.49	12.4	50	1.27	0.60	15.2	0.28	163	202	15	15
6		0.41	10.4	0.62	15.8										
8		0.49	12.4	0.71	18.0										
▲ 546-31-3411 ▲ 546-31-3418 ▲ 546-31-3436	14(7X) (2.08mm ²)	11	0.57	14.5	0.80	20.3	50	1.27	0.91	23.1	0.65	395	475	12	10
18		0.69	17.5	0.93	23.6										
36		0.97	24.6	1.24	31.5										
▲ 546-31-3452 ▲ 546-31-3456 ▲ 546-31-3458	12(7X) (3.31mm ²)	2	0.34	8.6	0.53	13.5	50	1.27	0.64	16.3	0.32	200	239	20	20
6		0.47	11.9	0.67	17.0										
8		0.56	14.2	0.80	20.3										
▲ 546-31-3461 ▲ 546-31-3468 ▲ 546-31-3486	12(7X) (3.31mm ²)	11	0.65	16.5	0.89	22.6	50	1.27	1.00	25.4	0.79	519	599	15	12
18		0.78	19.8	1.02	25.9										
36		1.10	27.9	1.37	34.8										
546-31-3502 ▲ 546-31-3506	10(7X) (5.26mm ²)	2	0.39	9.9	0.58	14.7	50	1.27	0.69	17.5	0.37	253	292	30	30
6		0.54	13.7	0.75	19.1										
▲ 546-31-3508 ▲ 546-31-3511	10(7X) (5.26mm ²)	8	0.65	16.5	0.89	22.6	50	1.27	1.00	25.4	0.79	568	648	28	24
11		0.75	19.1	0.97	24.6										

Okonite's web site, www.okonite.com contains the most up to date information.

▲ **Authorized Stock Item.** Available from our Customer Service Centers.

Copper or Bronze C-L-X - is available on special order.

†**Cross-sectional** area for calculation of cable tray fill in accordance with NEC Section 392.22.

Jackets - Optional jacket types available - consult local sales office.

(1) **Ampacities** are based on Table 310.16 of the National Electrical Code for XHHW-2 conductors rated 90°C, in a multi-conductor cable, at an ambient temperature of 30°C (86°F). The 75°C column is provided for additional information.

The ampacities shown apply to open runs of cable, installation in any approved raceway, direct burial in the earth, or as aerial cable on a messenger. Derating for more than three current carrying conductors within the cable is in accordance with NEC Section 310.15(B)(1).

The ampacities shown also apply to cables installed in cable tray in accordance with NEC Section 392.80

*Current limited to 15, 20 and 30 amps per Section 240.4(D) of the NEC for #14, #12 and #10 AWG, respectively.

C-L-X[®] Type MC-HL (XHHW-2)

UL 600/1000V and CSA 600V Control Cable - Aluminum Sheath

Multiple Copper Conductors/90°C Wet or Dry Rating

600/1000V Marine Shipboard Cable

For Cable Tray Use - Sunlight Resistant - For Direct Burial



Product Data Section 4: Sheet 15

Conductor Color Coding Sequence

Ungrounded Conductor Number	Base Color	Tracer Color
1	Black	
2	Red	
3	Blue	
4	Orange	
5	Yellow	
6	Brown	
7	Red	Black
8	Blue	Black
9	Orange	Black
10	Yellow	Black
11	Brown	Black
12	Black	Red
13	Blue	Red
14	Orange	Red
15	Yellow	Red
16	Brown	Red
17	Black	Blue
18	Red	Blue
19	Orange	Blue
20	Yellow	Blue
21	Brown	Blue
22	Black	Orange
23	Red	Orange
24	Blue	Orange
25	Yellow	Orange
26	Brown	Orange
27	Black	Yellow
28	Red	Yellow
29	Blue	Yellow
30	Orange	Yellow
31	Brown	Yellow
32	Black	Brown
33	Red	Brown
34	Blue	Brown
35	Orange	Brown
36	Yellow	Brown
37	Black	

Color Coding per ICEA Method 1, E-2

Special Order: Any or all of the following conductors may be added when specifically requested by the customer to meet their specific application requirements. These conductor codings comply with UL and NEC requirements.

<u>Purpose</u>	<u>Base Color</u>	<u>Tracer Color</u>
Equipment Grounding	Uninsulated Green Green	1 or more continuous yellow stripes
Grounded	White	Black continuous stripe
	White	Red continuous stripe
	White	Blue continuous stripe
	White	Orange continuous stripe
	White	Brown continuous stripe
	White	Numeric printing



Type P-OS

Type ITC/PLTC Instrumentation Cable

Single Pair or Triad - Overall Shield
300 Volts - 105°C Rating



For Cable Tray Use



- A** Bare Stranded Copper Conductor
- B** Okoseal Insulation
- C** Twisted Pair/Triad
- D** Tinned Stranded Copper Drain Wire
- E** Aluminum/Polyester Tape
- F** Rip Cord
- G** Black Okoseal Jacket

Specifications

Conductors: Bare soft annealed copper, Class B, 7-strand concentric per ASTM B-8.

Insulation: Flame-retardant Okoseal® (PVC) per UL 13 and UL 2250, 15 mils nominal thickness, 105°C temperature rating.

Conductor Identification: Pigmented black and white in pairs, black, red and white in triads.

Assembly: Pair or triad assembled with left-hand lay.

Cable Shield: Aluminum/synthetic polymer tape overlapped to provide 100% coverage, and a 7-strand tinned copper drain wire.

Jacket: Black, flame-retardant, low temperature Okoseal per UL 13 and UL 2250. A rip cord is laid longitudinally under the jacket to facilitate removal.

Classifications

UL Listed as ITC/PLTC — Instrument Tray Cable/Power Limited Tray Cable for use in accordance with Article 335 and Article 722 of the 2023 National Electrical Code.

These cables comply with UL 2250 for ITC and UL 13 for PLTC, CL2, and CL3.

Applications

Okonite type P-OS (Pair/Triad - Overall Shield) instrumentation cables are designed for use as instrumentation, process control, and computer cables in ITC non-classified or labeled circuits up to 150 volts and 5 amps (750VA) and in Class 2 or 3 Power-Limited circuits where shielding against external interference is required, but shielding against interference among groups is not required; indoors or outdoors; in wet or dry locations with conductor operating temperatures up to 105°C; in cable trays; in raceways; supported by a messenger wire. Suitable Class I, Division 2, Class II, Division 2, or Class III, Division 2 hazardous locations. Also for use as Power-Limited fire protective signaling cable (FPL) per NEC Code 760.

The overall shield eliminates most of the static interference from the electric field radiated by power cables and other electrical equipment.

For dc service in wet locations, X-Olene® insulation is recommended.

Product Features

- Passes the UL 1581 & IEEE 383-1974 vertical tray flame tests.
- Sunlight resistant and oil resistant.
- Individual pairs or triads are color coded for simplified hook-up.
- Good noise rejection.
- Excellent weathering characteristics.
- OSHA Acceptable.
- Flexible, easy to handle and terminate.
- Twisted with 100% shield coverage to reduce electromagnetic noise pick-up.
- Suitable for low temperature installation of -40°C.

Type P-OS

Type ITC/PLTC Instrumentation Cable

Single Pair or Triad - Overall Shield 300V - 105°C Rating
For Cable Tray Use



Product Data

Section 5: Sheet 2

Okoseal Insulation 15 mils

Catalog Number	Conductor Size (AWG)	Number of Pairs	Number of Triads	Insulation Thickness (mils)	Jacket Thickness (mils)	Nominal Cable O.D. - (In.)	Cross-Sectional Area † (sq in)	Approx Net Weight (lbs/1000')	Approx Ship Weight (lbs/1000')
264-10-1101 264-15-1101	22	1	1	12	35	0.20 0.21	0.03 0.03	22 26	27 31
264-10-2201 264-15-2201	20	1	1	12		0.22 0.23	0.04 0.04	27 33	32 38
▲ 264-10-3301 ▲ 264-15-3301	18	1	1	15		0.23 0.24	0.05 0.05	35 43	40 48
▲ 264-10-4401 264-10-4901* ▲ 264-15-4401	16	1	1	15		0.25 0.25 0.26	0.05 0.05 0.06	47 47 58	52 52 59

* Tinned Copper Conductor

ELECTRICAL SPECIFICATIONS Per UL Standard 13 & 2250	
Conductor Resistance, nominalohms/1000 ft. @20°C
22 AWG 16.5
20 AWG 10.3
18 AWG 6.5
16 AWG 4.1
Insulation Test Voltage (spark test)5000 Volts ac
Dielectric Test Voltage 1500 Volts ac for 15 sec.
Insulation Resistance Constant @60°F minimum (natural material typical value)2000 Megohms-1000 ft.
Loop Resistance, nominal (2 conductor)	ohms-1000 ft @20°C
22 AWG 33.0
20 AWG 20.8
18 AWG 13.0
16 AWG 8.2
Mutual Capacitance (PF/ft.)*	
#22 34
#20 37
#18 41
#16 44

*Typical Value

▲ Authorized Stock Item: Available from our Customer Service Center.

† Cross-sectional area for calculation of cable tray fill in accordance with NEC Section 392-22

Length Tolerance: Cut lengths of 1000 feet or longer are subject to a tolerance of ± 10%; less than 1000 feet ± 15%.



C-L-X[®] Type P-OS

Type ITC/PLTC Armored Instrumentation Cable

Single Pair or Triad - Overall Shield

300 Volts - 105°C Rating

For Cable Tray Use

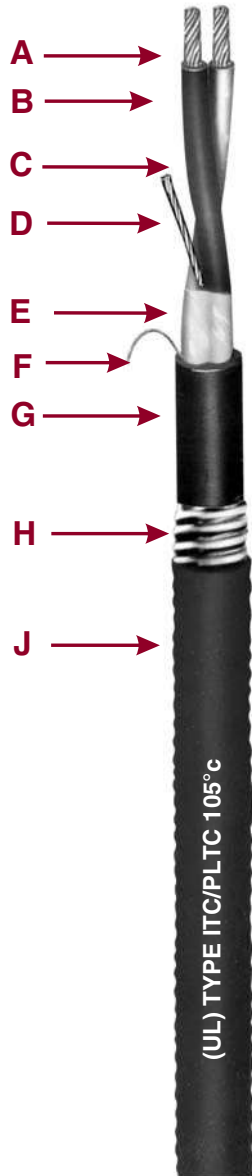

- A Bare Stranded Copper Conductor
- B Okoseal Insulation
- C Twisted Pair/Triad
- D Tinned Stranded Copper Drain Wire
- E Aluminum/Polyester Tape
- F Rip Cord
- G Inner Black Okoseal Jacket
- H Impervious, Continuous Corrugated Aluminum C-L-X Sheath
- J Outer Black Okoseal Jacket

Specifications

Conductors: Bare soft annealed copper, Class B, 7-strand concentric per ASTM B-8.

Insulation: Flame-retardant Okoseal[®] (PVC) per UL 13 and UL 2250, 15 mils nominal thickness, 105°C temperature rating.

Conductor Identification: Pigmented black and white in pairs, black, red and white in triads.

Assembly: Pair or triad assembled with left-hand lay.

Cable Shield: Aluminum/Polyester tape overlapped to provide 100% coverage, and a #18 AWG, 7-strand tinned copper drain wire.

Inner Jacket: Black, flame-retardant Okoseal per UL 13 and UL 2250. A rip cord is laid longitudinally under the jacket to facilitate removal.

C-L-X Sheath: A close-fitting, impervious, continuously welded and corrugated aluminum sheath provides complete protection against moisture, liquids, and gases, has excellent mechanical strength and provides equipment grounding through the sheath.

Outer Jacket: Black, flame-retardant Okoseal per UL 13 and UL 2250.

Classifications

UL Listed as ITC/PLTC — Instrument Tray Cable/Power Limited Tray Cable for use in accordance with Article 335 and Article 722 of the 2023 National Electrical Code.

These cables comply with UL 2250 for ITC and UL 13 for PLTC, CL2 and CL3.

Applications

Okonite Type C-L-X P-OS (Pair/Triad - Overall Shield) instrumentation cables are designed for use as instrumentation, process control, and computer cables in ITC non-classified or labeled circuits up to 150 volts and 5 amps (750VA) and in Class 2 or 3 Power-Limited circuits where shielding against external interference is required, but shielding against interference among groups is not required; indoors or outdoors; in wet or dry locations with conductor operating temperatures up to 105°C; in cable trays; in raceways; supported by a messenger wire; under raised floors; for direct burial. Suitable Class I, Division 2, and Class I, Zone 2 Class II, Division 2, or Class III, Division 1 and Class I, Zone 2 hazardous locations. Also for use as Power-Limited fire protective signaling cable (FPL) per NEC Article 760. The C-L-X sheath provides physical protection against mechanical

damage. It may be installed in both exposed and concealed work, secured to supports not greater than 6 feet apart.

The overall shield eliminates most of the static interference from the electric field radiated by power cables and other electrical equipment.

For dc service in wet locations, X-Olene[®] insulation is recommended.

Product Features

- Passes the UL 1581, IEEE 383-1974, and IEEE 1202 vertical tray flame tests.
- Passes the 210,000 BTU/hr vertical tray flame test per ICEA T-29-520.
- UL listed as sunlight resistant.
- UL listed for direct burial.
- Complete pre-packaged, factory-tested wiring system-color coded.
- C-L-X enclosure permits installation in cable tray containing light and power cables without a barrier separator.
- Individual pairs or triads are color coded for simplified hook-up.
- Maximum noise rejection.
- Impervious, continuous sheath excludes moisture, gases and liquids.
- In addition, the aluminum CLX sheath exceeds the equipment grounding requirements of NEC Articles 250.118 and 250.122, and can be used as the equipment grounding conductor.
- Excellent compression and impact resistance.
- Lower installed system cost than conduit or EMT systems.
- Suitable for low temperature installation of -40°C.

C-L-X Type P-OS

Type ITC/PLTC Armored Instrumentation Cable

Single Pair or Triad - Overall Shield 300V - 105°C Rating
For Cable Tray Use

Product Data

Section 5: Sheet 3



Conductors: 16 AWG
Okoseal Insulation: 15 mils

Catalog Number	Number of Pairs	Number of Triads	Inner Jacket Thickness-mils	Inner Jacket Nominal O.D. - Inches	Outer Jacket - (mils)	C-L-X O.D. - Inches	Nominal Cable O.D. - Inches	Cross-Sectional Area † (sq in)	Approx Net Weight (lbs/1000')	Approx Ship Weight (lbs/1000')
▲ 564-10-3401	1	35	.26	50	.43	.54	.25	134	173	
▲ 564-15-3401	1	35	.28	50	.43	.54	.25	155	194	

ELECTRICAL SPECIFICATIONS Per UL Standard 13 & 2250

Conductor Resistance, nominalohms/1000 ft. @20°C
16 AWG..... 4.1
Insulation Test Voltage (spark test).....5000 Volts ac
Dielectric Test Voltage..... 1500 Volts
Insulation Resistance Constant @60°F minimum
(natural material typical value).....2000 Megohms-1000 ft.
Loop Resistance, nominal (2 conductor) ohms-1000 ft @20°C
16 AWG..... 8.2
Mutual Capacitance, typical76 PF/ft.

▲ **Authorized Stock Item:** Available from our Customer Service Center
† **Cross-sectional** area for calculation of cable tray fill in accordance with NEC Section 392.22.

Jackets- Optional jacket types available - consult local sales office.

Copper or bronze C-L-X available on special order.

To order C-L-X Type P-OS without the outer Okoseal jacket, change the sixth digit of the catalog number from 3 to 1, for example to order 1 pr. 16 AWG with a bare aluminum C-L-X, the catalog number would be 564-10-1401.

Length Tolerance: Cut lengths of 1000 feet or longer are subject to a tolerance of ± 10%; less than 1000 feet ± 15%.





Type SP-OS

Type ITC/PLTC Instrumentation Cable

Multiple Shielded Pairs or Triads - Overall Shield
300 Volts - 105°C Rating



For Cable Tray Use

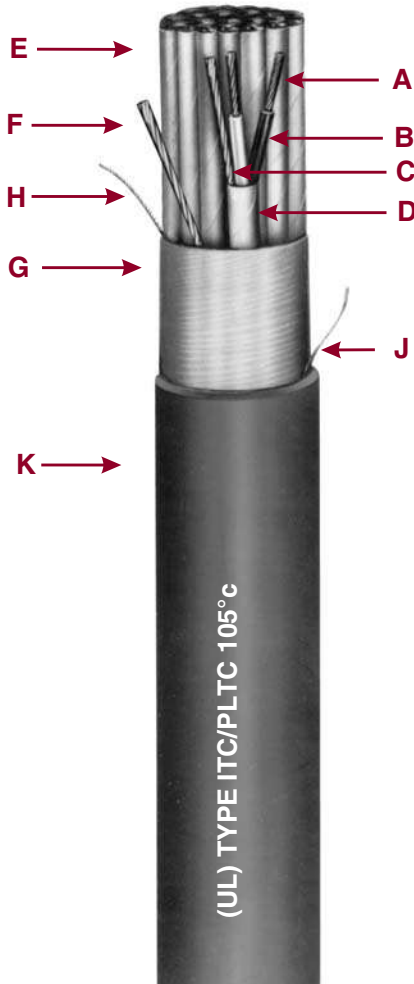

- A Bare Stranded Copper Conductor
- B Okoseal Insulation
- C Tinned Stranded Copper Group Drain Wire
- D Aluminum/Polyester Tape
- E Twisted, Shielded Pairs/Triads
- F Tinned Stranded Copper Drain Wire
- G Aluminum/Polyester Tape
- H Communication Wire
- J Rip Cord
- K Black Okoseal Jacket

Specifications

Conductors: Bare soft annealed copper, Class B, 7-strand concentric per ASTM B-8.

Insulation: Flame-retardant Okoseal® (PVC) per UL 13 and UL 2250, 15 mils nominal thickness, 105°C temperature rating.

Conductor Identification: Pigmented black and white in pairs, black, red and white in triads; white conductor numerically printed for group identification.

Group Shield: Aluminum/Polyester tape overlapped to provide 100% coverage, and a 7-strand tinned copper drain wire, two sizes smaller than the conductor. All group shields are completely isolated from each other.

Communications Wire: 22 AWG, solid, bare copper conductor, 12 mils nominal flame-retardant Okoseal insulation, 105°C rating.

Assembly: Pairs or triads assembled with a left-hand lay. Flame-retardant, non-wicking fillers included where required to provide a round cable.

Cable Shield: Aluminum/Polyester tape overlapped to provide 100% coverage, and a 7-strand tinned copper drain wire, same size as conductor.

Jacket: Black, flame-retardant, low temperature Okoseal per UL 13 and UL 2250. A rip cord is laid longitudinally under the jacket to facilitate removal.

Classifications: UL Listed as ITC/PLTC - Instrument Tray Cable/Power Limited Tray Cable for use in accordance with Article 335 and Article 722 of the 2023 National Electrical Code.

Cables comply with UL 2250 for ITC and UL 13 for PLTC, CL2 and CL3.

Applications

Okonite® Type SP-OS (Pair/triad - Individual and Overall Shield) instrumentation cables are designed for use as instrumentation, process control, in ITC non-classified or labeled circuits up to 150 volts and 5 amps (750VA) and in Class 2 or 3 Power-Limited circuits where maximum shielding against external interference is required, as well as shielding among

groups, particularly where the cable may be subject to abnormally high current or voltage interference; indoors or outdoors; in wet or dry locations with conductor operating temperatures up to 105°C; in cable trays; in raceways; supported by a messenger wire; under raised floors. Suitable Class I, Division 2, Class II, Division 2, or Class III, Division 2 hazardous locations. Also for use as Power-Limited fire protective signaling cable (FPL) per NEC Article 760.

The isolated individual shields over each pair, when properly grounded, prevent crosstalk or capacitive coupling between adjacent pairs which occurs with ac signals, particularly the pulse type.

The overall shield eliminates most of the static interference from the electrical field radiated by power cables and other electrical equipment.

For dc service in wet locations, X-Olene® insulation is recommended.

Product Features

- Passes the UL 13 and IEEE 383-1974 vertical tray flame tests.
- Sunlight & oil resistant.
- Individual pairs or triads are completely isolated.
- 100% shield coverage for reduced electromagnetic noise pick-up.
- Good external noise rejection.
- Excellent weathering characteristics.
- OSHA Acceptable.
- Flexible, easy to handle and terminate.
- Communication wire included in each cable for voice communication during installation or instrument calibration.
- Suitable for low temperature installation of -40°C.

Type SP-OS Type ITC/PLTC Instrumentation Cable



Product Data Section 5: Sheet 13

Multiple Shielded Pairs or Triads - Overall Shield 300V - 105°C Rating
For Cable Tray Use

Okoseal Insulation: 15 mils

Catalog Number	Strand Size (AWG)	Insulation Thickness (mils)	Number of Pairs	Number of Triads	Jacket Thickness-mils	Nominal Cable O.D. - inches	Cross-Sectional Area † (sq in)	Approx Net Weight (lbs/1000')	Approx Ship Weight (lbs/1000')	
261-10-2202	20(7X)	15	2	40	0.35	0.10	63	74		
261-10-2204			4	50	0.42	0.15	103	126		
261-10-2206			6	50	0.51	0.20	138	161		
261-10-2208			8	50	0.53	0.25	169	193		
261-10-2210			10	60	0.66	0.34	219	258		
261-10-2212			12	60	0.66	0.37	248	287		
261-10-2216			16	60	0.76	0.45	311	350		
261-10-2220			20	60	0.82	0.53	374	413		
261-10-2224			24	70	0.90	0.69	457	521		
261-10-2236			36	70	1.06	0.88	632	696		
261-10-2250			50	70	1.23	1.19	845	951		
261-15-2204			18(7X)	15	4	50	0.48	0.18	126	149
261-15-2208					8	50	0.62	0.30	212	236
261-15-2212					12	60	0.77	0.47	314	353
261-15-2216					16	60	0.79	0.49	397	436
261-15-2224					24	70	0.99	0.77	587	651
261-15-2236					36	70	1.11	0.97	825	905
261-10-3302					16(7X)	15	2	50	0.38	0.11
▲ 261-10-3304	4	50					0.47	0.19	133	156
261-10-3306	6	50					0.57	0.25	181	205
▲ 261-10-3308	8	50					0.56	0.29	223	247
261-10-3310	10	60					0.73	0.42	289	328
▲ 261-10-3312	12	60					0.69	0.44	330	369
261-10-3316	16	60					0.83	0.54	417	456
261-10-3320	20	70					0.94	0.69	523	587
▲ 261-10-3324	24	70					0.98	0.85	614	678
▲ 261-10-3336	36	70					1.14	1.11	861	941
261-10-3350	50	80					1.42	1.58	1188	1294
261-15-3304	16(7X)	15					4	50	0.52	0.23
261-15-3308			8	60			0.68	0.41	301	340
261-15-3312			12	60			0.83	0.57	425	464
261-15-3316			16	60			0.89	0.62	543	607
261-15-3324			24	70			1.10	0.95	804	884
261-15-3336			36	70			1.24	1.21	1143	1249
▲ 261-10-4402			16(7X)	15			2	50	0.43	0.17
▲ 261-10-4404					4	50	0.51	0.23	179	203
261-10-4406					6	60	0.66	0.34	260	299
▲ 261-10-4408					8	60	0.68	0.40	323	362
261-10-4410					10	60	0.82	0.53	397	436
▲ 261-10-4412					12	60	0.81	0.57	456	520
261-10-4416					16	70	0.94	0.75	600	664
261-10-4420					20	70	1.06	0.88	729	809
▲ 261-10-4424					24	70	1.10	1.07	860	940
261-10-4436					36	80	1.37	1.47	1250	1356
261-10-4450					50	80	1.57	1.93	1687	1830
261-15-4404					16(7X)	15	4	50	0.55	0.26
▲ 261-15-4408	8	60					0.74	0.48	418	457
▲ 261-15-4412	12	70					0.93	0.74	615	679
261-15-4416	16	70					1.02	0.82	788	852
261-15-4424	24	80					1.27	1.27	1167	1273
261-15-4436	36	80					1.43	1.61	1668	1784

ELECTRICAL SPECIFICATIONS Per UL Subject 13 & 2250	
Conductor Resistance, nominal	ohms/1000 ft. @20°C
20 AWG	10.4
18 AWG	6.5
16 AWG	4.1
Insulation Test Voltage (spark test)	5000 Volts ac
Dielectric Test Voltage	1500 Volts ac for 15 sec.
Insulation Resistance Constant @60°F, minimum (natural material typical value)	2,000 Megohms-1000 ft.
Loop Resistance, nominal (2 conductor)	ohms-1000 ft @20°C
20 AWG	20.8
18 AWG	13.0
16 AWG	8.2
Mutual Capacitance (PF/ft.)*	
20 AWG	59
18 AWG	68
16 AWG	76
*Typical Value	

▲ Authorized Stock Item: Available from our Customer Service Center.

† Cross-sectional area for calculation of cable tray fill in accordance with NEC Section 392.22

Length Tolerance: Cut lengths of 1000 feet or longer are subject to a tolerance of ± 10%; less than 1000 feet ± 15%.



THE OKONITE COMPANY

Ramsey, New Jersey 07446



C-L-X[®] Type SP-OS

Type ITC/PLTC Armored Instrumentation Cable

Multiple Shielded Pairs or Triads - Overall Shield

300 Volts - 105°C Rating

For Cable Tray Use

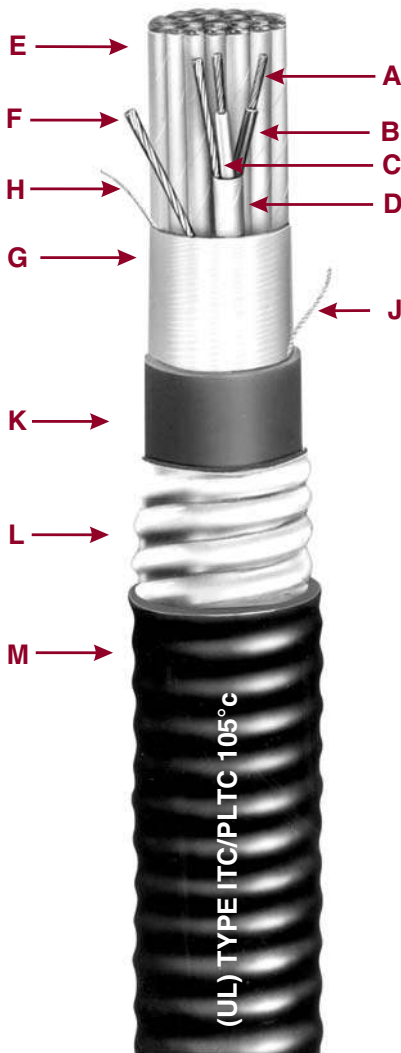

- A Bare Stranded Copper Conductor
- B Okoseal Insulation
- C Tinned Stranded Copper Group Drain Wire
- D Aluminum/Polyester
- E Twisted, Shielded Pairs/Triads
- F Communication Wire
- G Aluminum/Polyester
- H Tinned Stranded Copper Drain Wire
- J Rip Cord
- K Inner Black Okoseal Jacket
- L Impervious, Continuous, Corrugated Aluminum C-L-X Sheath
- M Outer Black Okoseal Jacket

Specifications

Conductors: Bare soft annealed copper, Class B, 7-strand concentric per ASTM B-8.

Insulation: Flame-retardant Okoseal[®] (PVC) per UL 13 and UL 2250, 15 mils nominal thickness, 105°C temperature rating.

Conductor Identification: Pigmented black and white in pairs, black, red and white in triads; white conductor numerically printed for group identification.

Group Shield: Aluminum/Polyester tape overlapped to provide 100% coverage, and a 7-strand tinned copper drain wire, two sizes smaller than the conductor. All group shields are completely isolated from each other.

Communications Wire: 22 AWG, solid, bare copper conductor, 12 mils nominal flame-retardant Okoseal insulation, 105°C temperature rating.

Assembly: Pairs or triads assembled with left-hand lay. Flame-retardant, non-wicking fillers included where required to provide a round cable.

Cable Shield: Aluminum/Polyester tape overlapped to provide 100% coverage, and a 7-strand tinned copper drain wire, same size as conductor.

Inner Jacket: Black, flame-retardant, low temperature Okoseal per UL 13 and UL 2250. A rip cord is laid longitudinally under the jacket to facilitate removal.

C-L-X Sheath: A close-fitting, impervious, continuously welded and corrugated, aluminum sheath provides complete protection against moisture, liquids, and gases, has excellent mechanical strength, and provides equipment grounding through the sheath.

Outer Jacket: Black, flame-retardant, low temperature Okoseal per UL 13 and UL 2250.

Classifications: UL Listed as ITC/PLTC - Instrument Tray Cable/Power Limited Tray Cable for use in accordance with Article 335 and Article 722 of the 2023 National Electrical Code.

Cables comply with UL 2250 for ITC and UL 13 for PLTC, CL2 and CL3.

Applications

C-L-X Type SP-OS (Pair/triad - Individual and Overall Shield) instrumentation cables are designed for use as instrumentation, process control, in ITC non-classified or labeled circuits up to 150 volts and 5 amps (750VA) and in Class 2 or 3 Power-Limited circuits where maximum shielding against external interference is required, as well as shielding among groups, particularly where the cable may be subject to abnormally high current or voltage interference; indoors or outdoors; in wet or dry locations with conductor operating temperatures up to 105°C; in cable trays; in raceways; supported by a

messenger wire; under raised floors or direct burial. Suitable in Class I & II, Division 2 or Class III, Division 1 and Class I, Zone 2 hazardous locations. Also for use as Power-Limited fire protective signaling cable (FPL) per NEC Article 760. It may be installed in both exposed and concealed work, secured to supports not greater than 6 feet apart.

The isolated individual shields over each pair, when properly grounded, prevent crosstalk or capacitive coupling between adjacent pairs which occurs with ac signals, particularly the pulse type.

The overall shield eliminates most of the static interference from the electric field radiated by power cables and other electrical equipment. The C-L-X sheath provides physical protection against mechanical damage as well as complete protection against moisture or gases entering the cable.

For dc service in wet locations X-Olene[®] insulation is recommended.

Product Features

- Passes the UL 13, IEEE 383-1974 vertical tray flame tests.
- Passes the IEEE 1202 vertical tray flame test (2 pr #18 AWG and larger).
- Passes the 210,000 BTU/hr vertical tray flame test per ICEA T-29-520.
- UL listed for direct burial (2 PR #20 AWG and larger)
- Complete pre-packaged, factory-tested wiring system-color coded.
- C-L-X enclosure permits installation in cable tray containing light and power cables without a barrier separator.
- Individual pairs or triads are completely isolated.
- Impervious, continuous sheath excludes moisture, gases and liquids.
- In addition, the aluminum CLX sheath exceeds the equipment grounding requirements of NEC Articles 250.118 and 250.122, and can be used as the equipment grounding conductor.
- Lower installed system cost than conduit or EMT systems.
- Suitable for low temperature installation to -40°C.

C-L-X Type SP-OS

Type ITC/PLTC Armored Instrumentation Cable

Multiple Shielded Pairs or Triads - Overall Shield 300V - 105°C Rating

For Cable Tray Use

Okoseal Insulation: 15 mils



Product Data Section 5: Sheet 14

Catalog Number	Strand Size (AWG)	Number of Pairs	Number of Triads	Inner Jacket Thickness - mils	Nominal Core O.D. (In.)	C-L-X O.D. (In.)	Outer Jacket mils	Nominal Cable O.D. - (In.)	Cross-Sectional Area † (sq in)	Approx Net Weight (lbs/1000')	Approx Ship Weight (lbs/1000')
561-10-3202	2	40	0.36	0.58	50	0.69	.37	198	217		
561-10-3204	4	50	0.43	0.62	50	0.73	.42	234	314		
561-10-3206	6	50	0.48	0.71	50	0.82	.53	286	366		
561-10-3208	8	50	0.53	0.75	50	0.86	.58	317	397		
561-10-3210	10	50	0.57	0.80	50	0.91	.65	393	473		
561-10-3212	12	60	0.63	0.84	50	1.95	.71	430	510		
561-10-3216	16	60	0.72	0.97	50	1.08	.92	501	581		
561-10-3220	20	60	0.81	1.06	50	1.17	1.08	581	661		
561-10-3224	24	70	0.90	1.15	50	1.26	1.25	704	794		
561-10-3236	36	70	1.04	1.34	50	1.45	1.65	907	1013		
561-10-3250	50	70	1.19	1.51	60	1.65	2.14	1230	1373		
561-15-3204	4	50	0.45	0.67	50	0.78	.48	258	338		
561-15-3208	8	50	0.56	0.80	50	0.91	.65	369	439		
561-15-3212	12	60	0.67	0.89	50	1.00	.79	504	584		
561-15-3216	16	60	0.77	1.02	50	1.13	1.00	604	684		
561-15-3224	24	70	0.96	1.24	50	1.35	1.43	852	958		
561-15-3236	36	70	1.11	1.42	50	1.53	1.84	1117	1260		
▲ 561-10-3302	2	40	0.38	0.58	50	0.69	0.37	212	292		
▲ 561-10-3304	4	50	0.49	0.71	50	0.82	0.53	273	353		
561-10-3306	6	50	0.55	0.75	50	0.86	0.58	338	418		
▲ 561-10-3308	8	50	0.60	0.80	50	0.92	0.65	389	469		
561-10-3310	10	60	0.67	0.89	50	1.00	0.79	479	559		
▲ 561-10-3312	12	60	0.71	0.93	50	1.04	0.85	529	609		
561-10-3316	16	60	0.79	1.06	50	1.17	1.08	632	738		
561-10-3320	20	60	0.88	1.15	50	1.26	1.25	778	868		
▲ 561-10-3324	24	70	0.98	1.24	50	1.35	1.43	889	995		
561-10-3336	36	70	1.15	1.47	50	1.58	1.96	1203	1346		
561-10-3350	50	80	1.36	1.69	60	1.82	2.60	1629	1812		
561-15-3304	4	50	0.54	0.75	50	0.86	.58	314	394		
561-15-3308	8	60	0.69	0.93	50	1.04	.85	475	555		
561-15-3312	12	60	0.79	1.06	50	1.17	1.08	632	712		
561-15-3316	16	70	0.90	1.15	50	1.26	1.25	781	861		
561-15-3324	24	70	1.06	1.34	50	1.45	1.65	1097	1240		
561-15-3336	36	80	1.29	1.60	60	1.73	2.35	1539	1682		
▲ 561-10-3402	2	50	0.44	0.67	50	0.78	0.48	255	336		
▲ 561-10-3404	4	50	0.52	0.71	50	0.82	0.53	327	407		
561-10-3406	6	50	0.59	0.84	50	0.95	0.71	434	514		
▲ 561-10-3408	8	60	0.69	0.93	50	1.04	0.85	505	585		
561-10-3410	10	60	0.75	1.02	50	1.13	1.00	604	684		
▲ 561-10-3412	12	60	0.81	1.06	50	1.17	1.08	671	777		
561-10-3416	16	70	0.95	1.24	50	1.35	1.43	855	945		
561-10-3420	20	70	1.03	1.34	50	1.45	1.65	1004	1101		
▲ 561-10-3424	24	70	1.10	1.37	50	1.48	1.72	1245	1388		
561-10-3436	36	80	1.29	1.60	60	1.73	2.35	1678	1842		
561-10-3450	50	80	1.53	1.87	60	2.00	3.14	2172	2428		
▲ 561-15-3404	4	50	0.58	0.80	50	0.91	0.65	384	464		
▲ 561-15-3408	8	60	0.79	1.02	50	1.13	1.00	609	689		
▲ 561-15-3412	12	70	0.95	1.19	50	1.30	1.33	862	952		
561-15-3416	16	70	1.04	1.34	50	1.45	1.65	1053	1159		
561-15-3424	24	80	1.27	1.60	60	1.73	2.35	1574	1738		
561-15-3436	36	80	1.49	1.83	60	1.96	3.02	2119	2306		

ELECTRICAL SPECIFICATIONS	
Conductor Resistance, nominalohms/1000 ft. @20°C
20 AWG.....	10.4
18 AWG.....	6.5
16 AWG.....	4.1
Insulation Test Voltage (spark test)5000 Volts ac
Dielectric Test Voltage.....	1500 Volts ac for 15 sec.
Insulation Resistance Constant @60°F minimum (natural material typical value)2000 Megohms-1000 ft.
Loop Resistance, nominal (2 conductor) ohms-1000 ft @20°C	
20 AWG.....	20.8
18 AWG.....	13.0
16 AWG.....	8.2
Mutual Capacitance (PF/ft.)*	
#20.....	59
#18.....	68
#16.....	76
*Typical Value	

▲ Authorized Stock Item: Available from our Customer Service Center.

Jackets - Optional jacket types available - consult local sales office.

† Cross-sectional area for calculation of cable tray fill in accordance with NEC Section 392.22.

Copper or bronze C-L-X available on special order. To order C-L-X Type SP-OS without the outer Okoseal jacket, change the sixth digit of the catalog number from 3 to 1. For example, to order 12 pr. 20 AWG with a bare aluminum C-L-X, the catalog number would be 561-10-1212.

Length Tolerance: Cut lengths of 1000 feet or longer are subject to a tolerance of ± 10%; less than 1000 feet ± 15%.



THE OKONITE COMPANY

Ramsey, New Jersey 07446



Type P-OS

Type ITC/PLTC Thermocouple Extension Cable

Single Pair - Overall Shield - 105°C Rating
For Cable Tray Use



- A Solid Thermocouple Alloy Conductor
- B Okoseal Insulation
- C Twisted Pair/Triad
- D Tinned Stranded Copper Drain Wire
- E Aluminum/Polyester Tape
- F Rip Cord
- G Okoseal Jacket

Specifications

Conductors: Solid alloys per ANSI MC 96.1

Insulation: Flame-retardant Okoseal® (PVC) per UL 13 and UL 2250, 15 mils nominal thickness, 105°C temperature rating.

Conductor Identification: Pigmented insulation on individual conductors.

Assembly: Pair assembled with left-hand lay.

Cable Shield: Aluminum/Polyester tape overlapped to provide 100% coverage, and a 7-strand tinned copper drain wire, same size as conductor.

Jacket: Flame-retardant, low temperature Okoseal per UL 13 and UL 2250. A rip cord is laid longitudinally under the jacket to facilitate removal.

Classifications: UL Listed as Type ITC/PLTC - Instrumentation Tray Cable/Power Limited Tray Cable, for use in accordance with Article 335 and 722 of the 2023 National Electrical Code. Cables comply with UL 2250 for ITC and UL 13 for PLTC, CL2 and CL3.

Applications

Okonite Type P-OS (Pair-Overall Shield) thermocouple extension cables are designed for use as instrumentation and process control cables in ITC non-classified or labeled circuits up to 150 volts and 5 amps (750VA) and in Class 2 of 3 Power-Limited circuits where shielding against external interference is required, but shielding against interference among groups is not required; indoors or outdoors; in wet or dry locations with conductor operating temperatures up to 105°C; in cable trays; in raceways; supported by a

messenger wire; under raised floors; for direct burial. Suitable Class I, Division 2, Class II, Division 2, or Class III, Division 1 hazardous locations.

Product Features

- Passes the UL 1581 & IEEE 383-1974 vertical tray flame tests.
- Sunlight resistant & oil resistant.
- UL listed for direct burial.
- Individual pairs are color coded for simplified hook-up.
- Good noise rejection.
- Excellent weathering characteristics.
- Flexible, easy to handle terminate.
- Twisted with 100% shield coverage to reduce electromagnetic noise.
- Suitable for low temperature installation of -40°C.

Type P-OS

Type ITC/PLTC Thermocouple Extension Cable

Single Pair - Overall Shield - 105°C Rating
For Cable Tray Use

Product Data

Section 5: Sheet 18



Conductors: 16 AWG
Okoseal Insulation: 15 mils

ASA/ISA Type	Catalog Number	Number of Pairs	Jacket Thickness (mils)	Nominal Cable O.D. - (in.)	Cross-Sectional Area † (sq in)	Approx Net Weight (lbs/1000')	Approx Ship Weight (lbs/1000')
EX	▲ 284-20-1401	1	35	.24	.05	44	49
JX	▲ 284-20-2401	1	35	.24	.05	44	49
KX	▲ 284-20-3401	1	35	.24	.05	44	49
TX	284-20-4401	1	35	.24	.05	44	49

ASA/ISA COLOR CODE AND LIMITS OF ERROR									
ASA/ISA Type	Positive Wire		Negative Wire		Outer Jacket Color	Temperature Range°C	Limits of Error		Nom. Loop Resistance Per 100' @ 20°C
	Alloy	Color	Alloy	Color			Standard	Special (1)	
EX	Chromel	Purple	Constantan	Red	Purple	0 to 200°C	± 1.7°C		27.8 ohms
JX	Iron	White	Constantan	Red	Black	0 to 200°C	± 2.2°C	± 1.1°C	13.9 ohms
KX	Chromel	Yellow	Alumel	Red	Yellow	0 to 200°C	± 2.2°C		23.6 ohms
TX	Copper	Blue	Constantan	Red	Blue	-60 to 100°C	± 1.0°C	± 0.5°C	12.0 ohms

▲ Authorized Stock Item: Available from our Customer Service Center.

SX available upon request.

(1) Special grade alloy conductors for JX and TX are available on special order.

† Cross-sectional area for calculation of cable tray fill in accordance with NEC Section 392.22

ELECTRICAL SPECIFICATIONS Per UL Standard 13 and 2250	
Insulation Test Voltage (spark test).....	5000 Volts ac
Dielectric Test Voltage.....	1500 Volts ac for 15 sec.
Shield Isolation Test	
Pair to Cable Shield.....	exceeds 100M ohms/1000 ft.
Insulation Resistance Constant @60°F minimum (natural material typical value).....	
	2000 Megohms-1000 ft.



C-L-X[®] Type P-OS Type ITC/PLTC Armored Thermocouple Extension Cable

Single Pair - Overall Shield - 105°C Rating
For Cable Tray Use

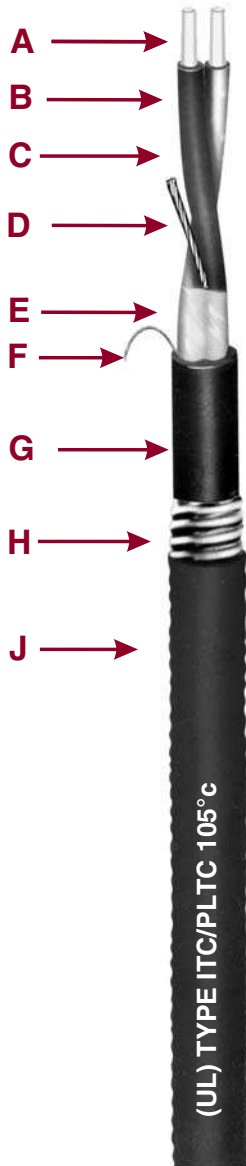

- A Solid Thermocouple Alloy Conductor
- B Okoseal Insulation
- C Twisted Pair
- D Tinned Stranded Copper Drain Wire
- E Aluminum/Polyester Tape
- F Rip Cord
- G Inner Okoseal Jacket
- H Impervious, Continuous, Corrugated Aluminum C-L-X Sheath
- J Outer Okoseal Jacket

Specifications

Conductors: Solid alloys per ANSI MC 96.1.

Insulation: Flame-retardant Okoseal[®] (PVC) per UL 13 and UL 2250, 15 mils nominal thickness, 105°C temperature rating.

Conductor Identification: Pigmented insulating on individual conductors.

Assembly: Pairs assembled with left-hand lay

Cable Shield: Aluminum/Polyester backed tape overlapped to provide 100% coverage, and a 7-strand tinned copper drain wire, same size as the conductor.

Inner Jacket: Black, flame-retardant, low temperature Okoseal per UL 13 and UL 2250. A rip cord is laid longitudinally under the jacket to facilitate removal.

C-L-X Sheath: Close fitting, impervious, continuously welded and corrugated aluminum sheath provides complete protection against moisture, liquids, and gases, has excellent mechanical strength and provides equipment grounding through the sheath.

Outer Jacket: Flame-retardant, low temperature Okoseal per UL 13 and UL 2250.

Classifications: UL Listed as Type ITC/PLTC - Instrumentation Tray Cable/Power Limited Tray Cable, for use in accordance with Article 335 and 722 of the 2023 National Electrical Code.

Cables comply with UL 2250 for ITC and UL 13 for PLTC, CL2 and CL3.

Applications

Okonite Type C-L-X P-OS (Pair/triad - Overall Shield) Thermocouple Extension cables are designed for use as instrumentation and process control cables in ITC non-classified or labeled circuits up to 150 volts and 5 amps (750VA) and in Class 2 or 3 Power-Limited circuits where shielding against external interference is required; indoors or outdoors; in wet or dry

location with conductor operating temperatures up to 105°C; in cable trays; in raceways; supported by a messenger wire; under raised floors; for direct burial. Suitable Class I, Division 2, Class II, Division 2, or Class III, Division 1 and Zone 2 hazardous locations. The C-L-X sheath provides physical protection against mechanical damage. It may be installed in both exposed and concealed work, secured to supports not greater than 6 feet apart.

Product Features

- Passes the UL 1581, IEEE 383-1974, & IEEE 1202 vertical tray flame tests.
- Passes the 210,000 BTU/hr vertical tray flame test per ICEA T-29-520.
- Complete pre-packaged, factory-tested wiring system-color coded.
- C-L-X enclosure permits installation in cable tray containing light and power cables without a barrier separator.
- Individual pairs are color coded for simplified hook-up.
- Impervious, continuous sheath excludes moisture, gases and liquids.
- In addition, the aluminum CLX sheath exceeds the equipment grounding requirements of NEC Articles 250.118 and 250.122, and can be used as the equipment grounding conductor.
- Lower installed system cost than conduit or EMT systems.
- UL listed for direct burial
- Suitable for low temperature installation of -40°C

C-L-X Type P-OS

Type ITC/PLTC Armored Thermocouple Extension Cable

Single Pair - Overall Shield - 105°C Rating
For Cable Tray Use



Product Data

Section 5: Sheet 19

Conductors: 16 AWG
Okoseal Insulation: 15 mils

ASA/ISA Type	Catalog Number	Number of Pairs	Inner Jacket Thickness - mils	Inner Jacket Nominal O.D. - Inches	C-L-X O.D. - Inches	Outer Jacket - mils	Nominal Cable O.D. - (In.)	Cross-Sectional Area (sq in) †	Approx Net Weight (lbs/1000')	Approx Ship Weight (lbs/1000')
EX	584-20-1401	1	35	.24	.43	50	.54	.23	128	167
JX	584-20-2401	1	35	.24	.43	50	.54	.23	128	167
KX	▲ 584-20-3401	1	35	.25	.43	50	.54	.23	128	167
TX	584-20-4401	1	35	.24	.43	50	.54	.23	128	167

ASA/ISA COLOR CODE AND LIMITS OF ERROR

ASA/ISA Type	Positive Wire		Negative Wire		Outer Jacket Color	Temperature Range °C	Limits of Error		Nom. Loop Resistance Per 100' @ 20°C
	Alloy	Color	Alloy	Color			Standard	Special (1)	
EX	Chromel	Purple	Constantan	Red	Purple	0 to 200°C	± 1.7°C		27.8 ohms
JX	Iron	White	Constantan	Red	Black	0 to 200°C	± 2.2°C	± 1.1°C	13.9 ohms
KX	Chromel	Yellow	Alumel	Red	Yellow	0 to 200°C	± 2.2°C		23.6 ohms
TX	Copper	Blue	Constantan	Red	Blue	-60 to 100°C	± 1.0°C	± 0.5°C	12.0 ohms

▲ **Authorized Stock Item:** Available from our Customer Service Centers.

SX available upon request.

(1) Special grade alloy conductors for JX and TX are available on special order.

† **Cross-sectional** area for calculation of cable tray fill in accordance with NEC Section 392.22.

Jackets - Optional jacket types available - consult local sales office.

Copper or bronze C-L-X available on special order.

To order C-L-X Type P-OS without the outer Okoseal jacket, change the sixth digit of the catalog number from 1 to 5 for EX, 2 to 6 for JX, 3 to 7 for KX, and 4 to 8 for TX. For example to order 12 pr. 20 AWG Type KX with a bare aluminum C-L-X, the catalog number would be 584-20-7212.

Length Tolerance: Cut lengths of 1000 feet or longer are subject to a tolerance of ± 10%; less than 1000 feet ± 15%.

ELECTRICAL SPECIFICATIONS Per UL Standard 2250

Insulation Test Voltage (spark test)	5000 Volts ac
Dielectric Test Voltage	1500 Volts ac for 15 sec.
Shield Isolation Test	
Pair to Cable Shield.....	exceeds 100M ohms/1000 ft.
Insulation Resistance Constant @60°F, minimum (natural material typical value).....	2000 Megohms-1000 ft.





Okoseal-N® Type P-OS

UL Type TC and cUL Type CIC Instrumentation Cable

Single Pair or Triad - Overall Shield
600 Volts - 90°C Rating Wet or Dry
600/1000V Marine Shipboard Cable



- A** Stranded Bare Copper Conductor
- B** Okoseal Insulation with Nylon Jacket
- C** Twisted Pair/Triad
- D** Stranded Tinned Copper Drain Wire
- E** Aluminum/Synthetic Polymer Tape
- F** Rip Cord
- G** Black Okoseal Jacket

Specifications

Conductors: Bare soft annealed copper, Class B, 7-strand concentric per ASTM B-8.

Insulation & Jacket: Flame-retardant Okoseal® (PVC), 15 mils nominal thickness, nylon jacket, 4 mil nominal thickness, 90°C temperature rating, per UL 1277.

Conductor Identification: Pigmented black and white in pairs, black, white and red in triads.

Assembly: Pair or triad assembled with left-hand lay.

Cable Shield: Aluminum/Polyester tape overlapped to provide 100% coverage, and a 7-strand tinned copper drain wire, same size as conductor.

Jacket: Black, flame-retardant, low temperature Okoseal per UL 1277, 90°C temperature rating. A rip cord is laid longitudinally under the jacket to facilitate removal.

Classification: UL Listed as Type TC Article 336 of the National Electrical Code.

Applications

Okonite's single pair or triad Type P-OS instrumentation cables are designed for use on Class 1 Remote-Control Signaling circuits or where a 600V cable is desired, as instrumentation, process control, or computer cable transmitting signals at levels above 100 milli-volts in circuits where shielding against external interference is required, but shielding against interference among groups is not required. For use indoors or outdoors; wet or dry locations; in cable trays; in raceways; supported by a messenger wire; in Class I, Division 2, Class II, Division 2 or Class III, Division 1 hazardous locations. Also for use as non power limited fire alarm circuit cable (NPLF) per NEC Article 760. Type TC cables can be labeled Okomarine to be used in ABS and

Coast Guard approved marine applications.

Product Features

- UL listed for cable tray use (all sizes).
- Flame Retardant - passes the vertical tray flame test requirements of IEEE 383-1974 & 1202/FT4 and UL 1277.
- May be combined with 600V power and control cables in the same tray.
- Sunlight resistant & oil resistant
- Individual pairs or triads are color coded for simplified hook-up.
- Good noise rejection.
- Excellent weathering characteristics.
- Flexible, easy to handle and terminate.
- Twisted with 100% shield coverage to reduce electromagnetic pick-up.
- Suitable for installation in low temperature installations to -40°C.
- CSA C22.2 No. 239 Type CIC.
- UL 1309 Oko-Marine.
- UL certified to IEEE 1580-Marine Shipboard Cable rated 600/1000V.

Okoseal-N Type P-OS



Product Data Section 5: Sheet 29

UL Type TC and cUL Type CIC Instrumentation Cable

Single Pair or Triad - Overall Shield

600V - 90°C Rating Wet or Dry

600/1000V Marine Shipboard Cable

Okoseal Insulation: 15 mils
Nylon Jacket: 4 mils

Catalog Number	Size AWG	Number of Pairs	Number of Triads	Jacket Thickness-(mils)	Nominal Cable O.D. - (in.)	Cross-Sectional Area † (sq in)	Approx Net Weight (lbs/1000')	Approx Ship Weight (lbs/1000')
▲ 264-60-3301	18	1	45	0.27	0.06	48	53	
264-65-3301	18	1		0.29	0.07	54	59	
▲ 264-60-4401	16	1		0.29	0.07	56	61	
▲ 264-65-4401	16	1		0.31	0.08	69	80	
▲ 264-60-5501	14	1		0.32	0.09	75	86	
264-65-5501	14	1		0.34	0.10	94	105	

ELECTRICAL SPECIFICATIONS Per UL Standard 1277

Conductor Resistance, maximum ohms/1000 ft.

	@ 20°C	@ 25°C
18 AWG	6.09	7.04
16 AWG	4.34	4.43
14 AWG	2.72	2.78

Insulation Test Voltage (spark test)

18 - 16 AWG	6000 volts ac
14 AWG	7500 volts ac

Dielectric Test Voltage

18-16 AWG	1500 volts ac for 1 minute
14 AWG	2000 volts ac for 1 minute

Shield Isolation Test

Pair to Cable Shield . . . exceeds 100 Megohms/1000 ft.

Insulation Resistance Constant @ 60°F minimum (natural material typical value) . . . 2000 Ohms-1000 ft.

Loop Resistance, nominal (2 conductor) ohms-1000 ft @ 20°C

18 AWG	12.18	14.08
16 AWG	8.68	8.86
14 AWG	5.44	5.56

† Cross-sectional area for calculation of cable tray fill in accordance with NEC Section 392-22

Length Tolerance: Cut lengths of 1000 feet or longer are subject to a tolerance of ± 10%; less than 1000 feet ± 15%.

▲ **Authorized Stock Item:** Available from our Customer Service Centers.

Mutual Capacitance	18 AWG	49 pF/ft
	16 AWG	56 pF/ft
	14 AWG	64 pF/ft
L/R ratio	18 AWG	14 micro Henry/ohm
	16 AWG	21 micro Henry/ohm
	14 AWG	31 micro Henry/ohm
Inductance	18 AWG	0.19 micro Henry/ft
	16 AWG	0.18 micro Henry/ft
	14 AWG	0.17 micro Henry/ft





Okoseal-N® Type SP-OS

UL Type TC and cUL Type CIC Instrumentation Cable

Multiple Shielded Pairs or Triads - Overall Shield

600 Volts - 90°C Rating Wet or Dry

600/1000V Marine Shipboard Cable



- A** Stranded Bare Copper Conductor
- B** Okoseal Insulation with Nylon Jacket
- C** Tinned Stranded Copper Group Drain Wire
- D** Double Faced Aluminum/Synthetic Polymer Backed Tape
- E** Twisted, Shielded Pairs/Triads
- F** Double Faced Aluminum/Synthetic Polymer Backed Tape
- G** Stranded Tinned Copper Drain Wire
- H** Rip Cord
- J** Black Okoseal Jacket

Specifications

Conductors: Bare soft annealed copper, Class B, 7-strand concentric per ASTM B-8.

Insulation: Flame-retardant Okoseal® (PVC), 15 mils nominal thickness, nylon jacket, 4 mil nominal thickness, 90°C temperature rating, per UL 1277.

Conductor Identification: Pigmented black and white in pairs; black, white and red in triads.

Group Shield: Aluminum/Polyester tape overlapped to provide 100% coverage, and a 7-strand tinned copper drain wire, two sizes smaller than the conductor. All group shields are completely isolated from each other.

Assembly: Pairs or triads assembled with left-hand lay.

Cable Shield: Aluminum/Polyester tape overlapped to provide 100% coverage, and a 7-strand tinned copper drain wire, same size as conductor.

Jacket: Black, flame-retardant, low temperature Okoseal per UL 1277, 90°C temperature rating. A rip cord is laid longitudinally under the jacket to facilitate removal.

Classification: UL Listed as Type TC Article 336 of the National Electrical Code.

Applications

Okonite's Type SP-OS (Shielded pairs or triads - Overall Shield) instrumentation cables are designed for use on Class 1 Remote-Control Signaling circuits or where a 600V cable is desired, as instrumentation, process control, or computer cable transmitting signals at levels above 100 milli-volts in circuits where maximum noise protection is required. Protection from interference among groups as well as external sources is provided by individual group shields as well as an overall cable shield. For use indoors or outdoors; wet or dry locations; in raceways; supported by a messenger wire; for direct burial; in Class I, Division 2, Class II, Division 2 or Class III, Division 1 hazardous locations. Also for use as non power limited fire alarm circuit cable (NPLF) per NEC Article 760. As an option, type TC cables can be labeled Okomarine to be used in ABS and Coast Guard approved marine applications, on special order.

Product Features

- UL listed for cable tray use (all sizes).

- Passes the UL 1277 and IEEE 383-1974 vertical tray flame tests.
- Passes IEEE 1202/FT4 vertical tray flame test.
- May be combined with 600 volt power and control cables in the same tray.
- Sunlight resistant and oil resistant.
- UL listed for direct burial (8/pr #16 AWG and larger)
- Individual pairs or triads are numbered and color-coded for simplified hook-up.
- Individual pairs or triads are completely isolated.
- 100% shield coverage for reduced electromagnetic noise pick-up.
- Excellent weathering characteristics.
- Flexible, easy to handle and terminate.
- Suitable for installation at low temperatures to -40°C.
- CSA C22.2 No. 239 Type CIC.
- UL 1309 Oko-Marine.
- UL certified to IEEE 1580-Marine Shipboard Cable rated 600/1000V.

Okoseal-N Type SP-OS



Product Data Section 5: Sheet 31

UL Type TC and cUL Type CIC Instrumentation Cable

Single Pairs or Triads - Individual and Overall Shield

600V - 90°C Rating Wet or Dry

600/1000V Marine Shipboard Cable

Okoseal Insulation - 15 mils; Nylon Jacket - 4 mils

Catalog Number	Size AWG Strands	Number of Pairs	Number of Triads	Jacket Thickness- (mils)	Nominal Cable O.D. - (In.)	Cross-Sectional Area † (sq in)	Approx Net Weight (lbs/1000')	Approx Ship Weight (lbs/1000')
261-60-3302	18 (7x)	2	45	0.42	0.14	83	96	
261-60-3304		4	45	0.50	0.20	138	161	
261-60-3308		8	60	0.67	0.35	254	297	
261-60-3310	18 (7x)	10	60	0.77	0.46	316	355	
261-60-3312		12	80	0.81	0.51	395	459	
261-60-3316		16	80	0.93	0.67	496	559	
261-60-3320	18 (7x)	20	80	1.07	0.90	597	677	
261-60-3324		24	80	1.09	0.93	699	779	
261-60-3336		36	80	1.28	1.29	974	1080	
261-60-3350	18 (7x)	50	80	1.55	1.89	1307	1450	
261-65-3304		4	60	0.61	0.29	196	220	
261-65-3308			8	60	0.75	0.44	317	356
261-65-3312	12		80	0.95	0.71	516	580	
261-65-3316	16 (7x)	16	80	1.09	0.93	652	732	
261-65-3324		24	80	1.34	1.41	940	1046	
261-65-3336		36	80	1.53	1.84	1319	1462	
▲ 261-60-4402	16 (7x)	2	45	0.44	0.15	114	137	
▲ 261-60-4404		4	60	0.58	0.26	198	222	
▲ 261-60-4408		8	60	0.72	0.47	337	376	
261-60-4410	16 (7x)	10	80	0.94	0.69	452	516	
▲ 261-60-4412		12	80	0.91	0.65	515	579	
▲ 261-60-4416		16	80	1.04	0.85	639	692	
261-60-4420	16 (7x)	20	80	1.19	1.11	787	867	
▲ 261-60-4424		24	80	1.18	1.09	925	1031	
261-60-4436		36	80	1.40	1.54	1304	1410	
261-60-4450	16 (7x)	50	110	1.79	2.52	1866	2053	
261-65-4404		4	60	0.61	0.29	252	291	
▲ 261-65-4408			8	80	0.79	0.49	478	542
▲ 261-65-4412	12		80	1.00	0.79	674	754	
261-65-4416	14 (7x)	16	80	1.12	0.99	858	964	
261-65-4424		24	80	1.50	1.77	1245	1388	
261-65-4436		36	80	1.71	2.30	1761	1948	
261-60-5502	14 (7x)	2	45	0.51	0.21	147	163	
261-60-5504		4	60	0.68	0.36	272	311	
261-60-5508		8	80	0.91	0.65	511	575	
261-60-5510	14 (7x)	10	80	1.06	0.88	627	707	
261-60-5512		12	80	1.09	0.93	721	801	
261-60-5516 •		16	80	1.20	1.13	919	1025	
261-60-5520 •	14 (7x)	20	80	1.34	1.41	1120	1226	
261-60-5524 •		24	80	1.48	1.72	1322	1428	
261-60-5536 •		36	80	1.67	2.19	1886	2029	
261-60-5550 •	14 (7x)	50	110	2.02	3.20	2681	2973	
261-65-5504		4	60	0.75	0.44	351	390	
261-65-5512			12	80	1.23	1.19	954	1060
261-65-5516 •	14 (7x)	16	80	1.36	1.45	1225	1331	
261-65-5524 •		24	80	1.69	2.24	1794	1987	
261-65-5536 •		36	110	2.00	3.14	2683	2975	

ELECTRICAL SPECIFICATIONS Per UL Standard 1277			
Conductor Resistance, maximumohms/1000 ft.			
		@20°C	@25°C
18 AWG	6.09	7.04
16 AWG	4.34	4.43
14 AWG	2.72	2.78
Insulation Test Voltage (spark test)			
18 - 16 AWG	6000 VOLTS AC	
14 AWG	7500 VOLTS AC	
Dielectric Test Voltage2000 Volts ac for 1 minute			
Insulation Resistance Constant @ 60F, minimum			
(natural material typical value) 2000 ohms/1000 ft.			
Loop Resistance, maximum (2 conductor)ohms-1000 ft			
		@20°C	@25°C
18 AWG	12.18	14.08
16 AWG	8.68	8.86
14 AWG	5.44	5.56

• Contains 41-strand tinned copper overall drain wire, same size as conductor.

† Cross-sectional area for calculation of cable tray fill in accordance with NEC Section 392.22

Length Tolerance: Cut lengths of 1000 feet or longer are subject to a tolerance of ± 10%; less than 1000 feet ± 15%.

▲ Authorized Stock Item: Available from our Customer Service Centers.





C-L-X[®] Okoseal-N[®] P-OS

UL Type MC-HL and cUL Type ACIC-TC Instrumentation Cable
Single Pair or Triad-Overall Shield
600 Volts 90°C Rating - 600/1000V Marine Shipboard Cable
For Cable Tray Use - Sunlight Resistant - For Direct Burial

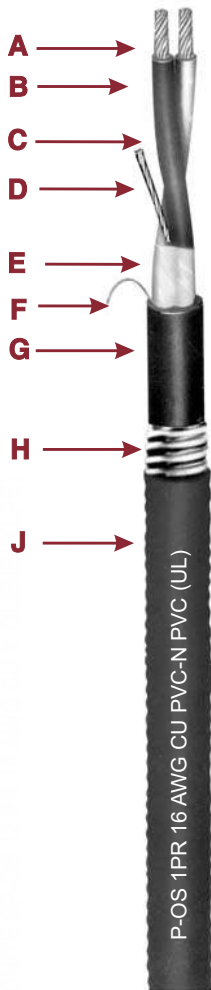

- A Bare Stranded Copper Conductor
- B Okoseal Insulation/Nylon Jacket
- C Twisted, Shielded Pairs/Triads
- D Tinned Stranded Copper Drain Wire
- E Aluminum/Synthetic Polymer Tape
- F Rip Cord
- G Inner Black Okoseal Jacket
- H Impervious, Continuous, Corrugated Aluminum C-L-X Sheath
- J Outer Black Okoseal Jacket

Specifications

Conductors: Bare soft annealed copper, Class B, 7-strand concentric per ASTM B-8.

Insulation: Flame-retardant Okoseal (PVC) per UL 83, 15 mils nominal thickness, 90°C temperature rating.

Jacket: Nylon per UL 83, 8 mils nominal thickness.

Conductor Identification: Pigmented black and white in pairs; black, white and red in triads.

Assembly: Pairs or triads assembled with left-hand lay.

Cable Shield: Aluminum/Polyester tape overlapped to provide 100% coverage, and a #16 AWG stranded tinned copper drain wire.

Inner Jacket: Black, flame-retardant Okoseal per UL 1569. A rip cord is laid longitudinally under the jacket to facilitate removal.

C-L-X Sheath: A close-fitting, impervious, continuously welded and corrugated, aluminum sheath meeting UL 1569 provides complete protection against moisture, liquids, and gases, has excellent mechanical strength, and provides equipment grounding through the sheath.

Outer Jacket: Black, flame-retardant Okoseal per UL 1569.

Applications

Okonite C-L-X Single pair or triad type P-OS instrumentation cables are designed for use on Class 1 Remote-Control Signaling circuits or where a 600V cable is desired, as instrumentation, process control, or discrete signals at levels above 100 milli-volts in circuits where shielding against external interference is required, but shielding against interference among groups is not required. For use indoors or outdoors; wet or dry locations; in cable trays; in raceways; supported by a messenger wire; for direct burial; in Classes I, II, and III, Divisions 1 and 2 hazardous locations per NEC Articles 501, 502, 503, and 505.

The overall shield eliminates most of the static interference from the electric field radiated by power cables and other electrical equipment.

The C-L-X sheath provides physical protection against mechanical damage as well as complete protection against moisture or gases entering the cable.

For dc service in wet locations, X-Olene insulation is recommended.

Product Features

Complete pre-packaged, factory-tested wiring system—color coded.

C-L-X enclosure permits installation in cable tray containing light and power cables without a barrier separator.

Impervious, continuous sheath excludes moisture, gases and liquids.

Excellent compression and impact resistance. Lower installed system cost than conduit or EMT systems.

Suitable for low temperature installation to -40°C.

Applicable Standards

- UL listed for cable tray use, direct burial and sunlight resistant.
- Vertical Tray Flame Tests.
 - IEEE 383-1974, FT4/IEEE 1202,
 - ICEA T-29-520 (210,000 BTU)
- American Bureau of Shipping Type approved as CWCMC Type MC-HL.
- API Standards 14F and 14FZ.
- UL 2225 Type MC-HL
- UL 1309 (CWCMC) Marine Shipboard
- UL certified as Marine Shipboard in accord with IEEE 1580, rated 600/1000 volts.
- NPLF per NEC Article 760.
- CSA C22.2 No. 230 Type TC
- CSA C22.2 No. 239 Type ACIC

C-L-X[®] Okoseal-N[®] P-OS

UL Type MC-HL and cUL Type ACIC-TC Instrumentation Cable

Single Pair or Triad-Overall Shield

600 Volts 90°C Rating - 600/1000V Marine Shipboard Cable

For Cable Tray Use - Sunlight Resistant - For Direct Burial

Conductors: #16 AWG; Okoseal Insulation: 15 mils; Nylon Jacket: 8 mils

Product Data Section 5: Sheet 40



#16 AWG - Single Pair & Triad (P-OS) Type MC-HL

Catalog Number	Number of Pairs	Number of Triads	Inner Jacket Thickness-mils	Inner Jacket Nominal O.D. - inches	C-L-X O.D. - inches	Outer Jacket Thickness-mils	Nominal Jacket O.D. - inches	Cross-Sectional Area* Sq. in.	Net Weight Lbs./1000'	Ship Weight Lbs./1000'
▲ 564-60-3401	1		66	.35	.53	50	.64	0.32	182	221
▲ 564-65-3401		1	58	.35	.53	50	.64	0.32	190	229
564-60-3403	3		40	.45	.67	50	.78	0.48	247	640

ELECTRICAL SPECIFICATIONS

Conductor Resistance, maximum.....ohms/1000 ft.	
.....@20°C	@25°C
16 AWG4.34.....	4.43
Insulation Test Voltage (spark test).....6000 Volts ac	
Dielectric Test Voltage2000 Volts ac	
Shield Isolation Test	
Pair to Cable Shield.....exceeds 100 Megohms-1000 ft.	
Insulation Resistance Constant @60°F minimum	
(natural material typical value.....2000 Ohms-1000 ft.	
Loop Resistance, nominal (2 conductors).....ohms/1000 ft.	
.....@20°C.....	@25°C
16 AWG8.68.....	8.86
Mutual Capacitance (PF/ft.)*	
#16.....	.60
*Typical Value	

▲ **Authorized Stock Item.** Available from our Customer Service Centers.

* **Cross-sectional** area for calculation of cable tray fill in accordance with NEC Section 392.22.

Jackets: Optional jacket types available - consult local sales office.

Copper or bronze C-L-X available on special order.

To Order C-L-X Type P-OS without the outer Okoseal jacket (not "HL" listed), change the sixth digit of the catalog number from 3 to 1, for example to order 1 pr. 20 AWG with a bare aluminum C-L-X, the catalog number would be 564-10-1212.

Length Tolerance: Cut lengths of 1000 ft. or longer are subject to a tolerance of + \ -10%; less than 1000 feet + \ -15%.



C-L-X® Okoseal-N® SP-OS

UL Type MC-HL and cUL Type ACIC-TC Instrumentation Cable

Multiple Shielded Pairs or Triads - Individual and Overall Shield
600 Volts 90°C Rating MC-HL — 600/1000V Marine Shipboard Cable
For Cable Tray Use - Sunlight Resistant - For Direct Burial



- A Bare Stranded Copper Conductor
- B Okoseal Insulation/Nylon Jacket
- C Tinned Stranded Copper Group Drain Wire
- D Aluminum/Polyester Tape
- E Twisted, Shielded Pairs/Triads
- F Tinned Stranded Copper Drain Wire
- G Aluminum/Polyester Tape
- H Rip Cord
- J Inner Black Okoseal Jacket
- K Impervious, Continuous, Corrugated Aluminum C-L-X Sheath
- L Outer Black Okoseal Jacket

Specifications

Conductors: Bare soft annealed copper, Class B, 7-strand concentric per ASTM B-8.

Insulation: Flame-retardant Okoseal (PVC) per UL 83, 15 mils nominal thickness, 90°C temperature rating.

Insulation Jacket: Nylon per UL 83, 4 mils nominal thickness.

Conductor Identification: Pigmented black and white in pairs, black, white and red in triads.

Group Shield: Aluminum polyester tape overlapped to provide 100% coverage, and a 7-strand tinned copper drain wire, two sizes smaller than the conductor. All group shields are completely isolated from each other.

Assembly: Pairs or triads assembled with left-hand lay.

Cable Shield: Aluminum/polyester tape overlapped to provide 100% coverage, and a 7-strand tinned copper drain wire, same size as conductor.

Inner Jacket: Black, flame-retardant Okoseal per UL 1569. A rip cord is laid longitudinally under the jacket to facilitate removal.

C-L-X Sheath: A close-fitting, impervious, continuously welded and corrugated, aluminum sheath provides physical protection against mechanical damage. Additionally, C-L-X provides complete protection against moisture, liquids, and gases, and provides equipment grounding through the sheath.

Outer Jacket: Black, flame-retardant Okoseal per UL 1569.

Applications

Okonite C-L-X type SP-OS (shielded pairs or triads - overall shield) instrumentation cables are designed for use on Class 1 Remote-Control Signaling circuits or where a 600V cable is desired, as instrumentation, process control, or discrete signals at levels above 100 mili-volts in circuits where maximum noise protection is required. Protection from interference among groups as well as external sources is provided by individual group shields as well as an overall cable shield. For use indoors or outdoors; wet or dry locations; in cable trays, in raceways; supported by a messenger wire; for direct burial; in Classes I, II, and III, Divisions 1 and 2, Zones 1 and 2 hazardous locations per NEC Articles 501, 502, 503 and 505.

The isolated individual shields over each pair, when properly grounded, prevent crosstalk or capacitive coupling between adjacent pairs which occurs with ac signals, particularly the pulse type.

The overall shield eliminates most of the static interference from the electric field radiated by power cables and other electrical equipment. For dc service in wet locations, X-Olene insulation is recommended.

Product Features

Individual units are completely isolated for maximum noise rejection.

C-L-X enclosure permits installation in cable tray containing light and power cables without a barrier separator.

Lower installed system cost than conduit or EMT systems.

Suitable for low temperature installation to -40°C.

Applicable Standards

- UL listed for cable tray use, direct burial, in ducts, and sunlight resistant.
- Vertical Tray Flame Tests; IEEE 383-1974, FT4/ IEEE 1202, ICEA T-29-520 (210,000 BTU).
- American Bureau of Shipping Type approved as CWCMC Type MC-HL.
- API Standards 14F and 14FZ.
- UL 2225 Type MC-HL, UL 83, UL 1309 (CWCMC) Marine Shipboard, UL 1569
- UL certified to IEEE 1580 - Marine Shipboard Cable rated 600/1000V.
- NPLF per NEC Article 760.
- CSA C22.2 No. 230 Type TC.
- CSA C22.2 No. 239 Type ACIC.

C-L-X Okoseal-N SP-OS



Product Data Section 5: Sheet 42

UL Type MC-HL and cUL Type ACIC-TC Instrumentation Cable

Multiple Shielded Pairs or Triads - Individual and Overall Shield

600V 90°C Rating MC-HL — 600/1000V Marine Shipboard Cable

For Cable Tray Use - Sunlight Resistant - For Direct Burial

Conductors: #16 AWG; Okoseal Insulation: 15 mils; Nylon Jacket: 4 mils

Catalog Number	Number of Pairs	Number of Triads	Inner Jacket Thickness - mils	Nominal Core O.D. - Inches	C-L-X O.D. - Inches	Outer Jacket mils	Nominal Cable O.D. - Inches	Cross-Sectional Area* Sq. In.	Net Weight Lbs./1000'	Ship Weight Lbs./1000'
▲ 561-60-3402	2	40	0.45	0.67	50	0.76	0.45	234	314	
561-60-3403	3	40	0.49	0.70	50	0.82	0.53	278	369	
▲ 561-60-3404	4	50	0.56	0.80	50	0.91	0.65	335	415	
561-60-3406	6	50	0.66	0.89	50	1.00	0.79	421	501	
▲ 561-60-3408	8	50	0.70	0.93	50	1.04	0.85	492	572	
561-60-3410	10	50	0.79	1.06	50	1.17	1.08	601	681	
▲ 561-60-3412	12	50	0.85	1.11	50	1.22	1.17	674	780	
561-60-3416	16	50	0.98	1.29	50	1.40	1.54	842	948	
561-60-3420	20	50	1.06	1.34	50	1.45	1.65	977	1120	
▲ 561-60-3424	24	50	1.12	1.42	50	1.53	1.84	1118	1261	
▲ 561-60-3436	36	50	1.37	1.69	60	1.82	2.60	1586	1773	
561-60-3450	50	50	1.57	1.92	60	2.05	3.30	2124	2416	
561-65-3402	2	40	0.49	0.71	50	0.82	0.53	272	439	
▲ 561-65-3404	4	50	0.61	0.84	50	0.95	0.71	395	475	
▲ 561-65-3408	8	50	0.82	1.06	50	1.17	1.08	637	717	
▲ 561-65-3412	12	50	0.98	1.29	50	1.40	1.54	863	969	
561-65-3416	16	50	1.10	1.37	50	1.48	1.72	1058	1201	
561-65-3424	24	50	1.33	1.64	60	1.78	2.49	1485	1672	
561-65-3436	36	50	1.58	1.96	60	2.09	3.43	2141	2426	

ELECTRICAL SPECIFICATIONS

Conductor Resistance, nominalohms/1000 ft. @20°C
 16 AWG4.1
 Insulation Test Voltage (spark test)6000 Volts ac
 Dielectric Test Voltage2000 Volts ac for 60 sec.
 Insulation Resistance Constant @60°F minimum
 (natural material typical value) ..2000 Megohms-1000 ft.
 Loop Resistance, nominal (2 conductor).....ohms-1000 ft @20°C
 16 AWG8.2
 Mutual Capacitance (PF/ft.)*
 #1660
 *Typical Value

▲ **Authorized Stock Item:** Available from our Customer Service Centers.

***Cross-sectional area** for calculation of cable tray fill in accordance with NEC Section 392.22.

Jackets - Optional jacket types available - consult local sales office.

Copper or bronze C-L-X available on special order.

To order C-L-X Type SP-OS without the outer Okoseal jacket (not "HL" listed), change the sixth digit of the catalog number from 3 to 1, for example to order 1 pr. 20 AWG with a bare aluminum C-L-X, the catalog number would be 564-10-1212.

Length Tolerance: Cut lengths of 1000 ft. or longer are subject to a tolerance of + \ -10%; less than 1000 ft. + \ -15%





Okobus[®] C-L-X[®]



Single Pair: Type P-OS - Multi Pair: Type SP-OS

Type PLTC & Type ITC-HL Fieldbus Cable

Single Pair or Multiple Shielded Pairs - Overall Shield
300 Volts 75°C Rating

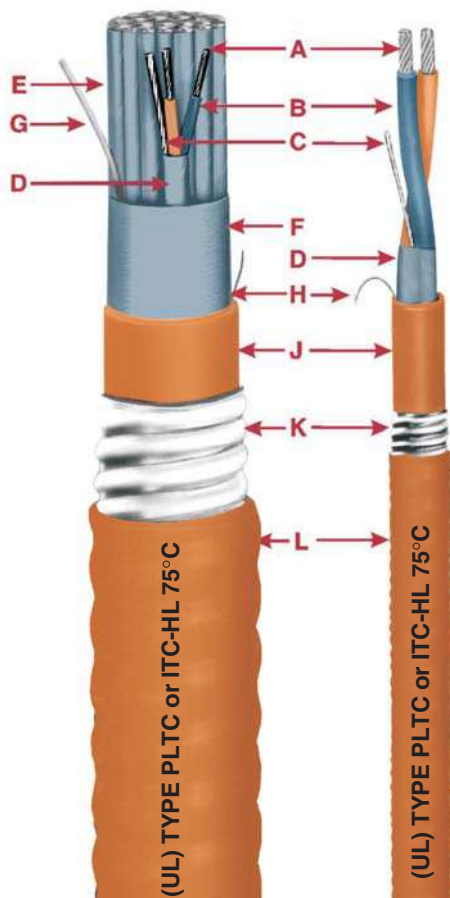

- A** Tinned Copper Stranded Conductor
- B** Polypropylene Insulation
- C** Tinned Stranded Copper Group Drain Wire
- D** Aluminum/Polyester Tape
- E** Twisted, Shielded Pairs
- F** Aluminum/Polyester Tape
- G** Tinned Stranded Copper Drain Wire
- H** Rip Cord
- J** Inner Orange Okoseal Jacket
- K** Impervious, Continuous, Corrugated Aluminum C-L-X Sheath
- L** Outer Orange Okoseal Jacket

Specifications

Conductors: #18 AWG tinned copper, Class M, stranded per ASTM B-174.

Insulation: Okolene[®] (Polypropylene) per UL 13 and UL 2250, 32 mils nominal thickness, 75°C temperature rating.

Conductor Identification: Pigmented orange and blue in pairs, orange conductor numerically printed for group identification.

Pair Shield: Aluminum/Polyester tape overlapped to provide 100% coverage, and a Class M tinned copper drain wire, two sizes smaller than the conductor. All multi-pair shields are isolated from each other.

Multiple Pair Assembly: Pairs assembled with a left-hand lay. Cable fillers included where required to provide a round cable.

Multiple Pair Cable Shield: Aluminum/Polyester tape overlapped to provide 100% coverage, and a class M strand tinned copper drain wire, same size as conductor.

Inner Jacket: Orange, flame-retardant, Okoseal[®] per UL 13 and UL 2250. A rip cord is laid longitudinally under the jacket to facilitate removal.

C-L-X Sheath: A close-fitting, impervious, continuously welded and corrugated, aluminum sheath provides complete protection against moisture, liquids, and gases, has excellent mechanical strength, and provides equipment grounding through the sheath.

Outer Jacket: Orange, flame-retardant, Okoseal per UL 13 and UL 2250.

Classifications: UL Listed as PLTC-Power Limited Tray Cable and as ITC-HL - Instrument Tray Cable/Hazardous Locations for use in accordance with Article 335 and Article 722 of the 2023 National Electrical Code.

Cables comply with ISA S50.02, UL 2250 and UL 13 for Fieldbus circuits and CL2 and CL3.

Applications

C-L-X OKOBUS[®] cables are designed for use in rugged plant and environments uti-

lizing networked discrete or process automation and control. ITC-HL (Instrument Tray Cable - Hazardous Locations) eliminates the need for conduit when installed in accordance with NEC Article 501.10(A)(1)(5) "ITC-HL" installations. Fully complies with ANS/ISA 50.02 Part 2 Fieldbus Cable.

The isolated individual shields over each pair, in SP-OS cables, when properly grounded, prevent crosstalk or capacitive coupling between adjacent pairs which occurs with ac signals, particularly the pulse type.

The overall shield eliminates most of the static interference from the electrical field radiated by power cables and other electrical equipment.

The C-L-X sheath provides additional electrical shielding and physical protection against mechanical damage as well as complete protection against moisture or gases entering the cable.

Product Features

- Passes the UL 13 and IEEE 383 vertical tray flame tests.
- Passes IEEE 1202 vertical tray flame test.
- Sunlight & oil resistant.
- UL listed for direct burial.
- Complete pre-packaged, factory-tested wiring system-color coded.
- C-L-X enclosure permits installation in cable tray containing lighting and power cables without a barrier separator.
- Individual pairs are completely isolated.
- Impervious, continuous sheath excludes moisture, gases and liquids.
- In addition, the aluminum CLX sheath exceeds the equipment grounding requirements of NEC Articles 250.118 and 250.122, and can be used as the equipment grounding conductor in non-HL areas.
- Lower installed system cost than conduit or EMT systems.

Okobus — C-L-X

Single Pair Type P-OS - Multi Pair Type SP-OS Type PLTC & Type ITC-HL Fieldbus Cable

Single Pair or Multiple Shielded Pairs - Overall Shield 300 V 75°C Rating

#18 AWG



Product Data Section 5: Sheet 48

Catalog Number	Number of Pairs	Inner Jacket Thickness - mils	Nominal Core O.D. Inches	C-L-X O.D. Inches	Outer Jacket mils	Nominal Cable O.D. - Inches	Cross-Sectional Area † (sq in)	Approx Net Weight (lbs/1000')	Approx Ship Weight (lbs/1000')
564-92-3301	1	45	0.34	0.53	40	0.62	0.30	155	194
561-92-3302	2	50	0.55	0.80	50	0.91	0.65	311	391
561-92-3304	4	60	0.71	0.93	50	1.04	0.85	400	480
561-92-3306	6	60	0.81	1.06	50	1.17	1.08	493	573
561-92-3308	8	70	0.91	1.15	50	1.26	1.25	587	693
561-92-3312	12	70	1.04	1.34	50	1.45	1.65	759	902
561-92-3316	16	70	1.17	1.47	50	1.58	1.96	902	1045
561-92-3320	20	80	1.33	1.64	50	1.75	2.41	1072	1236
561-92-3324	24	80	1.46	1.78	50	1.89	2.81	1308	1495

† Cross-sectional area for calculation of cable tray fill in accordance with NEC Section 392.22.

Copper or bronze C-L-X available on special order.

Length Tolerance: Cut lengths of 1000 feet or longer are subject to a tolerance of ± 10%; less than 1000 feet ± 15%.

CHARACTERISTICS

- a) Characteristic Impedance, Z_0 , at fr (31.25kHz), minimum100 ohms
- b) Maximum attenuation at 1.25 fr (39 kHz).....3.0 dB/km
- c) Maximum capacitive unbalance to shield.....2 nF/km
- d) Maximum DC resistance (per conductor)24 ohms/km
- e) Maximum propagation delay change 0.25 fr to 1.25 fr.....1.7 μ s/km
- f) conductor cross-sectional area nominal (wire size)0.8 mm² (#18 AWG)
- g) Minimum shield coverage100%





C-L-X[®] X-Olene[®] SP-OS

UL Type MC-HL, PLTC, ITC-HL and cUL ACIC-TC Instrumentation Cable
Multiple Shielded Pairs/Triads - Overall Shield

600 Volts 90°C Rating: UL MC-HL and cUL ACIC-TC

300 Volts 90°C Rating: UL PLTC & ITC-HL

For Cable Tray Use Sunlight Resistant For Direct Burial -50°C



- A** Copper Stranded Conductor
- B** X-Olene Insulation
- C** Tin Coated Copper Group Drain Wire
- D** Aluminum/Polyester Tape
- E** Twisted, Shielded Pairs
- F** Aluminum/Polyester Tape
- G** Tin Coated Copper Drain Wire
- H** Rip Cord
- J** Inner Okoseal Jacket
- K** Impervious, Continuous, Corrugated Aluminum C-L-X Sheath
- L** Outer Okoseal Jacket

Specifications

Conductors: Bare copper, Class B, stranded per ASTM B8.

Insulation: X-Olene[®] (XLPE), per UL 13, 2250 & 1569, 30 mils nominal thickness, 90°C temperature rating. Meets MIL-DTL-1377H, section 4.8.4.1.2 Cold Bend at -66°C and ASTM D746-04 brittlepoint at -76°C.

Conductor Identification: Pigmented black and white in pairs, black, red and white in triads; white conductor numerically printed for group identification.

Pair Shield: Aluminum/Polyester tape overlapped to provide 100% coverage, and a Class B tin coated copper drain wire, two sizes smaller than the conductor. All multi-pair shields are isolated from each other.

Multiple Pair Assembly: Pairs/triads assembled with a left-hand lay. Cable fillers included where required to provide a round cable.

Multiple Pair Cable Shield: Aluminum/Polyester tape overlapped to provide 100% coverage, and a class B strand tin coated copper drain wire, same size as conductor.

Inner Jacket: Black, flame-retardant, low temperature Okoseal[®] (PVC) per UL 13 and UL 2250. The inner jacket meets the thickness requirements of UL 1277. A rip cord is laid longitudinally under the jacket to facilitate removal.

C-L-X Sheath: A close-fitting, impervious, continuously welded and corrugated, aluminum sheath provides complete protection against moisture, liquids, and gases, has excellent mechanical strength, and provides equipment grounding through the sheath.

Outer Jacket: Black, flame-retardant, low temperature Okoseal per UL 13 and UL 2250.

Applications

These cables eliminate the need for conduit. Can be installed as Type PLTC in accordance with Article 722, and as Type ITC in accordance with Article 335 of the 2023 National Electrical Code.

They can also be installed as Type MC-HL and Type ITC-HL in Class I, II, and III, Divisions 1 and 2 hazardous location in accordance with NEC Articles 501, 502,

503, & 505; in Zone 2 per CEC for conductors #14 AWG & larger.

The isolated individual shields over each pair, in SP-OS cables, when properly grounded, prevent crosstalk or capacitive coupling between adjacent pairs while the overall shield eliminates most of the static interference from the electrical field radiated by power cables and other electrical equipment.

Product Features

Complete pre-packaged, factory-tested wiring system-color coded.

C-L-X enclosure permits installation in cable tray containing lighting and power cables without a barrier separator.

Lower installed system cost than conduit or EMT systems.

Applicable Standards

- UL listed for cable tray use, direct burial, in ducts, and sunlight resistant.
- Vertical Tray Flame Tests; IEEE 383-1974 & FT4/IEEE 1202.
- UL listed at -50°C. Also, meets the CSA 22.2 No.3 Cold Impact Test at -45°C.
- UL 13 Type PLTC & UL 2250 Type ITC.
- UL 2225 Type MC-HL & UL 1569.
- CSA C22.2 No. 230 Type TC
- CSA C22.2 No. 239 type ACIC
- cUL listed as Type ACIC-TC complies with CEC Zone 2 Hazardous Locations.

C-L-X® X-Olene® SP-OS



Product Data Section 5: Sheet 49

UL Type MC-HL, PLTC, ITC-HL and cUL ACIC-TC Instrumentation Cable

Multiple Shielded Pairs/Triads - Overall Shield

600 Volts 90°C Rating: UL MC-HL and cUL ACIC-TC

300 Volts 90°C Rating: UL PLTC & ITC-HL

For Cable Tray Use Sunlight Resistant For Direct Burial -50°C

Catalog Number	Number of Pairs	Number of Triads	Inner Jacket Thickness - mils	Nominal Core O.D. Inches	C-L-X O.D. Inches	Outer Jacket mils	Nominal Cable O.D. - Inches	Cross-Sectional Area † (sq in)	Approx Net Weight (lbs/1000')	Approx Ship Weight (lbs/1000')
#16 AWG										
567-70-3402	2	60	0.58	0.80	50	0.91	0.65	325	405	
567-70-3404	4	60	0.70	0.93	50	1.04	0.85	424	504	
567-70-3408	8	80	0.92	1.19	50	1.30	1.33	650	752	
567-70-3412	12	80	1.10	1.37	50	1.48	1.73	842	985	
567-70-3424	24	80	1.44	1.78	60	1.91	2.87	1450	1640	
567-70-3436	36	110	1.82	2.19	60	2.32	4.23	2145	2480	
567-71-3402	2	60	0.64	0.89	50	1.00	0.79	376	456	
567-71-3404	4	60	0.75	1.02	50	1.13	1.00	500	580	
567-71-3408	8	80	1.06	1.34	50	1.45	1.64	800	945	
567-71-3412	12	80	1.26	1.56	60	1.69	2.24	1090	1235	
567-71-3424	24	80	1.65	2.01	60	2.14	3.61	1914	2199	
#18 AWG										
567-70-3302	2	45	0.50	0.71	50	0.82	0.53	253	333	
567-70-3304	4	60	0.67	0.89	50	1.00	0.79	365	445	
567-70-3308	8	60	0.83	1.06	50	1.17	1.08	503	583	
567-70-3312	12	80	1.00	1.29	50	1.40	1.54	693	799	
567-70-3324	24	80	1.34	1.64	60	1.78	2.48	1125	1290	
567-70-3336	36	80	1.55	1.92	60	2.05	3.29	1545	1835	
567-71-3302	2	60	0.62	0.84	50	0.95	0.71	326	406	
567-71-3304	4	60	0.73	0.97	50	1.08	0.92	428	508	
567-71-3308	8	80	0.98	1.24	50	1.35	1.43	658	764	
567-71-3312	12	80	1.15	1.47	50	1.58	1.96	860	1003	
567-71-3324	24	80	1.58	1.96	60	2.09	3.42	1505	1760	

ELECTRICAL SPECIFICATIONS

Conductor Resistance, nominal - ohms/1000 ft.@20°C	@25°C
16 AWG	4.34
18 AWG	6.93
Insulation Test Voltage (spark test)	7500 Volts ac
Dielectric Test Voltage	3000 Volts ac
Insulation Resistance Constant @60°F minimum ...	10,000 ohms-1000 ft.
Loop Resistance, nominal (2 cdr.) - ohms/1000 ft .@20°C	@25°C
16 AWG	8.68
18 AWG	13.9

Mutual Capacitance (PF/ft.)*	
#16	23
#18	21

*Typical Value

† **Cross-sectional** area for calculation of cable tray fill in accordance with NEC Section 392.22.

Jackets - Optional jacket types available - consult local sales office.

Copper or bronze C-L-X available on special order. To order without the outer Okoseal jacket (not "HL" listed), change the sixth digit of the catalog number from 3 to 1, for example to order 2 pr. 16 AWG with a bare aluminum C-L-X, the catalog number would be 567-70-1402.

Length Tolerance: Cut lengths of 1000 feet or longer are subject to a tolerance of ± 10%; less than 1000 feet ± 15%.





X-Olene® Okoseal®
UL Type TC-ER/ITC -ER and cUL Type CIC-TC*
or Oko-Marine Cable

600 Volt Instrumentation/Signal Cable
600/1000V Marine Shipboard Cable
Single Pair/Triads or Multiple Pairs/Triads Type P-OS
For Cable Tray Use - Sunlight Resistant - For Direct Burial
***cUL CIC-TC-ER sizes 14 AWG & larger**

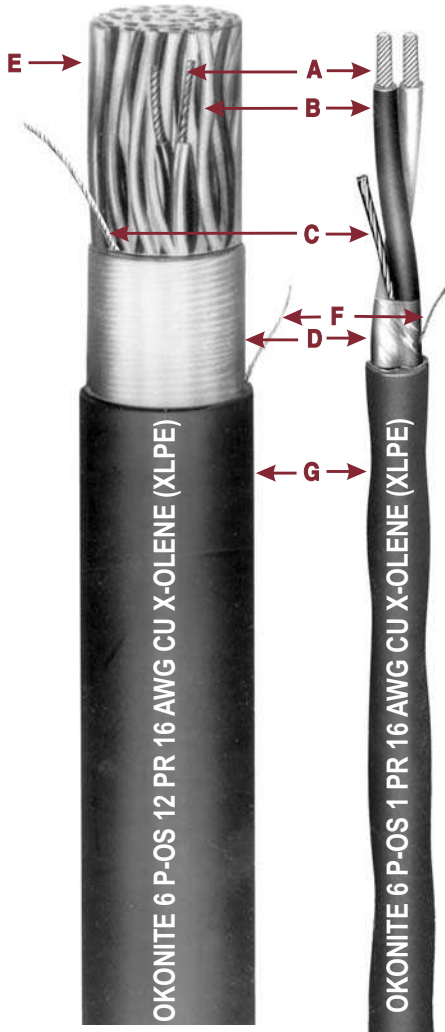

- A Copper Strand Conductor
- B X-Olene Insulation
- C Tinned Stranded Copper Drain Wire
- D Aluminum/Polyester Tape
- E Twisted Pairs
- F Rip Cord
- G Okoseal Jacket

Insulation

X-Olene® is Okonite's trade name for its cross-linked polyethylene (XLPE) insulation, with high dielectric strength.

Cable Jacket

The Okoseal (PVC) jacket supplied with this cable is mechanically rugged and has excellent resistance to acids and most chemicals and is rated for low temperature installations.

Applications

X-Olene Okoseal 600 volt shielded instrumentation cables are designed for use in rugged plant environments, such as Offshore Rig Projects, on Class 1 Remote-Control Signaling circuits or where a 600V instrumentation or control cable is desired. They are designed for use indoors or outdoors; wet or dry locations; in cable trays; in raceways; supported by a messenger wire; and for direct burial. Can be installed as Type TC/ITC in Class I, Division 2; Class II, Division 2; Class III, Division 1; and Zone 2 hazardous locations in accordance with NEC Articles 501.10, 502.10, 503.10, and 505.15. TC-ER (Tray Cable - Exposed Run) eliminates the need for conduit when installed in accordance with NEC Article 336.10(7). These cables are also UL labeled Okomarine and are listed for marine applications.

Specifications

Insulated Conductors: Bare soft annealed copper, Class B stranded per ASTM B8.

Insulation: X-Olene® (XLPE), 30 mils nominal thickness, 90°C temperature rating. Meets or exceeds requirements of UL 1277, UL 2250, UL 1309 Type X90 and IEEE 1580 Type X cross-linked polyethylene insulation.

Color Coding: Pigmented black and white in pairs, black, red and white in

triads; white conductor numerically printed for group identification.

Cable Shield: Aluminum/Polyester tape overlapped to provide 100% coverage, and a tinned-copper Class M drain wire same size as conductor. All multi-unit shields are isolated from each other.

Multiple Unit Assembly: Pairs/Triads assembled with a left-hand lay.

Jacket: Black Okoseal jacket. Complies with UL 1277, UL 2250, UL 1309 & IEEE 1580 Type T, thermoplastic polyvinyl chloride jacket.

UL Listed as Type TC-ER cable with a sunlight resistant jacket and for direct burial.

UL Listed as Type ITC-ER cable with a sunlight resistant jacket and for direct burial.

UL Listed as Type OKO-MARINE signal cable to the requirements of UL 1309. Also, UL certified as meeting the requirements of IEEE 1580 — Marine Cable.

Product Features

- For cable tray use and direct burial.
- Sunlight resistant.
- Insulated conductors are UL rated 90°C continuous rating in wet or dry locations.
- Flame Retardant - passes the vertical tray flame test requirements of IEEE 383-1974 & 1202-2010 and UL 1277.
- X-Olene Okoseal Type TC-ER/ITC-ER cables are quality control inspected to meet or exceed applicable industry standards.
- Resistant to moisture and most chemical atmospheres.
- Thermal stability at elevated temperatures.
- CSA C22.2 No. 239 & 230 Type CIC-TC (Type CIC-TC-ER for 14 AWG and larger).
- CSA C22.2 No. 245 Type Marine Shipboard.
- Passes -35°C cold bend test.

X-Olene® Okoseal®

UL Type TC-ER/ITC -ER and cUL Type CIC-TC* or Oko-Marine Cable

600 Volt Instrumentation/Signal Cable

600/1000V Marine Shipboard Cable

Single Pair/Triads or Multiple Pairs/Triads Type P-OS

For Cable Tray Use - Sunlight Resistant - For Direct Burial

*cUL CIC-TC-ER sizes 14 AWG & larger



Product Data Section 5: Sheet 50

Catalog Number	Number of Pairs	Number of Triads	Jacket Thickness-mils	Nominal Cable O.D. - Inches	Cross-Sectional Area † (sq. in.)	Approx. Net Weight (lbs./1000')	Approx. Ship Weight (lbs./1000')
#16 AWG							
▲267-40-3401	1	45	0.35	0.10	77	85	
▲267-41-3401	1	45	0.37	0.11	89	97	
267-40-3402	2	45	0.52	0.22	173	178	
267-40-3404	4	60	0.68	0.36	244	278	
267-40-3408	8	80	0.90	0.57	415	430	
267-40-3412	12	80	0.99	0.77	521	606	
267-40-3416	16	80	1.18	1.10	684	756	
267-40-3420	20	80	1.31	1.35	816	915	
267-40-3424	24	80	1.40	1.54	937	1094	
267-40-3436	36	80	1.60	2.01	1299	1433	
268-38-4402	2	60	0.65	0.33	240	261	
268-38-4404	4	60	0.78	0.47	307	366	
268-38-4408	8	80	1.02	0.81	559	617	
268-38-4412	12	80	1.21	1.14	742	809	
268-38-4416	16	80	1.36	1.46	931	1083	
268-38-4420	20	80	1.50	1.77	1118	1246	
268-38-4424	24	80	1.63	2.09	1296	1430	
#14 AWG							
267-40-3501	1	45	0.37	0.11	99	115	
267-41-3501	1	45	0.40	0.13	103	131	
267-40-3502	2	60	0.59	0.27	237	258	
267-40-3504	4	60	0.72	0.41	337	366	
267-40-3508	8	80	0.97	0.74	570	620	
267-40-3512	12	80	1.15	1.03	732	799	
267-40-3516	16	80	1.29	1.31	914	1066	
267-40-3520	20	80	1.42	1.59	1088	1247	
267-40-3524	24	80	1.57	1.93	1264	1398	
267-40-3536	36	110	1.57	2.92	1189	2198	
267-38-3502	2	60	0.63	0.31	291	314	
267-38-3504	4	60	0.77	0.46	430	459	
267-38-3508	8	80	1.03	0.84	731	789	
267-38-3512	12	80	1.22	1.18	978	1103	
267-38-3516	16	80	1.38	1.49	1238	1390	
267-38-3520	20	80	1.52	1.82	1496	1630	
267-38-3524	24	80	1.68	2.22	1748	1972	

ELECTRICAL SPECIFICATIONS

Conductor Resistance, nominal-ohms/1000 f.....@20°C.....@25°C	
16 AWG	4.34.....4.43
14 AWG	2.68.....2.73
Insulation Test Voltage (spark test).....	8000 Volts ac
Dielectric Test Voltage	1500 Volts ac
Insulation Resistance Constant @60°F minimum...10,000 ohms-1000 ft.	
Loop Resistance, nominal (2 cdr.) - ohms/1000 ft @20°C.....@25°C	
16 AWG	8.68.....8.86
14 AWG.....	5.36.....5.46
Mutual Capacitance (PF/ft.)*	
#16.....	23
#14.....	25
*Typical Value	

▲ **Authorized Stock Item.** Available from our Customer Service Centers.

† **Cross-sectional** area for calculation of cable tray fill in accordance with NEC Section 392.22.

Length Tolerance: Cut lengths of 1000 feet or longer are subject to a tolerance of ± 10%; less than 1000 feet ± 15%.



X-Olene® Okoseal® UL Type TC-ER/ITC -ER and cUL Type CIC-TC* or Oko-Marine Cable

600 Volt Instrumentation/Signal Cable

600/1000V Marine Shipboard Cable

Multi-Pair: Type SP-OS

For Cable Tray Use - Sunlight Resistant - For Direct Burial

***cUL CIC-TC-ER sizes 14 AWG & larger**



- A Copper Stranded Conductor
- B X-Olene Insulation
- C Tinned Stranded Copper Group Drain Wire
- D Aluminum/Polyester Tape
- E Twisted, Shielded Pairs
- F Aluminum/Polyester Tape
- G Tinned Stranded Copper Drain Wire
- H Rip Cord
- J Okoseal Jacket

Insulation

X-Olene® is Okonite's trade name for its cross-linked polyethylene (XLPE) insulation, with high dielectric strength.

Cable Jacket

The Okoseal (PVC) jacket supplied with this cable is mechanically rugged and has excellent resistance to acids and most chemicals and is rated for low temperature installations.

Applications

X-Olene Okoseal 600 volt shielded instrumentation cables are designed for use in rugged plant environments, such as Offshore Rig Projects, on Class 1 Remote-Control Signaling circuits or where a 600V instrumentation or control cable is desired. They are designed for use indoors or outdoors; wet or dry locations; in cable trays; in raceways; supported by a messenger wire; and for direct burial. Can be installed as Type TC/ITC in Class I, Division 2; Class II, Division 2; Class III, Division 1; and Zone 2 hazardous locations in accordance with NEC Articles 501.10, 502.10, 503.10, and 505.15.

TC-ER (Tray Cable - Exposed Run) eliminates the need for conduit when installed in accordance with NEC Article 336.10(7). These cables are also UL labeled Okomarine and are listed for marine applications.

Specifications

Insulated Conductors: Bare soft annealed copper, Class B stranded per ASTM B8.

Insulation: X-Olene® (XLPE), 30 mils nominal thickness, 90°C temperature rating. Meets or exceeds requirements of UL 1277, UL 2250, UL 1309 Type X90 and IEEE 1580 Type X cross-linked polyethylene insulation.

Color Coding: Pigmented black and white in pairs, black, red and white in triads; white conductor numerically

printed for group identification.

Unit Shield: Aluminum/Polyester tape overlapped to provide 100% coverage, and a tinned-copper Class M drain wire, two sizes smaller than conductor. All multi-unit shields are isolated from each other.

Multiple Unit Assembly: Pairs/Triads assembled with a left-hand lay.

Multiple Unit Cable Shield:

Aluminum/Polyester tape overlapped to provide 100% coverage, and a class M strand tinned copper drain wire, same size as the conductor.

Jacket: Black Okoseal jacket. Complies with UL 1277, UL 2250, UL 1309 & IEEE 1580 Type T, thermoplastic polyvinyl chloride jacket.

UL Listed as Type TC-ER cable with a sunlight resistant jacket and for direct burial.

UL Listed as Type ITC-ER cable with a sunlight resistant jacket and for direct burial.

UL Listed as Type OKO-MARINE signal cable to the requirements of UL 1309. Also, UL certified as meeting the requirements of IEEE 1580 — Marine Cable.

Product Features

- For cable tray use and direct burial.
- Sunlight resistant.
- Insulated conductors are UL rated 90°C continuous rating in wet or dry locations.
- Flame Retardant - passes the vertical tray flame test requirements of IEEE 383-1974 & 1202-2010 and UL 1277.
- X-Olene Okoseal Type TC-ER/ITC-ER cables are quality control inspected to meet or exceed applicable industry standards.
- Resistant to moisture and most chemical atmospheres.
- Thermal stability at elevated temperatures.
- CSA C22.2 No. 239 & 230 Type CIC-TC (Type CIC-TC-ER for 14 AWG and larger).
- CSA C22.2 No. 245 Type Marine Shipboard.
- Passes -35°C cold bend test.

X-Olene® Okoseal®

UL Type TC-ER/ITC -ER and cUL Type CIC-TC* or Oko-Marine Cable

600 Volt Instrumentation/Signal Cable

600/1000V Marine Shipboard Cable

Multi-Pair: Type SP-OS

For Cable Tray Use - Sunlight Resistant - For Direct Burial

*cUL CIC-TC-ER sizes 14 AWG & larger



Product Data Section 5: Sheet 51

Catalog Number	Number of Pairs	Number of Triads	Jacket Thickness-mils	Nominal Cable O.D. - Inches	Cross-Sectional Area † (sq. in.)	Approx. Net Weight (lbs./1000')	Approx. Ship Weight (lbs./1000')
#16 AWG							
▲ 268-40-3402	2	60	0.59	0.28	201	225	
▲ 268-40-3404	4	60	0.68	0.37	264	303	
▲ 268-40-3408	8	80	0.90	0.65	457	521	
▲ 268-40-3412	12	80	1.06	0.91	681	698	
268-40-3416	16	80	1.23	1.22	804	890	
268-40-3420	20	80	1.34	1.44	960	1044	
▲ 268-40-3424	24	80	1.44	1.66	1086	1213	
268-40-3436	36	110	1.82	2.68	1687	1837	
▲ 268-41-3402	2	60	0.66	0.35	245	287	
▲ 268-41-3404	4	60	0.78	0.49	335	374	
▲ 268-41-3408	8	80	1.03	0.85	605	668	
▲ 268-41-3412	12	80	1.22	1.19	806	912	
268-41-3416	16	80	1.38	1.52	1045	1128	
268-41-3420	20	80	1.52	1.86	1234	1377	
▲ 268-41-3424	24	80	1.65	2.18	1439	1582	
#14 AWG							
268-40-3502	2	60	0.65	0.33	267	288	
268-40-3504	4	60	0.73	0.42	354	403	
268-40-3508	8	80	0.98	0.75	621	688	
268-40-3512	12	80	1.16	1.06	848	923	
268-40-3516	16	80	1.32	1.37	1053	1233	
268-40-3520	20	80	1.46	1.67	1297	1464	
268-40-3524	24	80	1.56	1.91	1507	1648	
268-40-3536	36	110	1.90	2.83	2266	2571	
268-41-3502	2	60	0.69	0.37	322	351	
268-41-3504	4	60	0.77	0.47	443	496	
268-41-3508	8	80	1.04	0.85	790	859	
268-41-3512	12	80	1.24	1.21	1094	1228	
268-41-3516	16	80	1.42	1.58	1376	1559	
268-41-3520	20	80	1.56	1.91	1707	1840	
268-41-3524	24	80	1.67	2.19	1955	2216	

ELECTRICAL SPECIFICATIONS

Conductor Resistance, nominal-ohms/1000 f.....@20°C.....@25°C	
16 AWG	4.34.....4.43
14 AWG	2.68.....2.73
Insulation Test Voltage (spark test).....	8000 Volts ac
Dielectric Test Voltage	1500 Volts ac
Insulation Resistance Constant @60°F minimum...10,000 ohms-1000 ft.	
Loop Resistance, nominal (2 cdr.) - ohms/1000 ft @20°C.....@25°C	
16 AWG	8.68.....8.86
14 AWG.....	5.36.....5.46
Mutual Capacitance (PF/ft.)*	
#16.....	23
#14.....	25
*Typical Value	

▲ **Authorized Stock Item.** Available from our Customer Service Centers.
 † **Cross-sectional** area for calculation of cable tray fill in accordance with NEC Section 392.22.

Length Tolerance: Cut lengths of 1000 feet or longer are subject to a tolerance of ± 10%; less than 1000 feet ± 15%.



Okonite X-Ray/Hi-Voltage Cable

Low Noise

65kV, 75kV, 100kV, 230kV and 250kV dc Rating
Three Conductor or Four Conductor

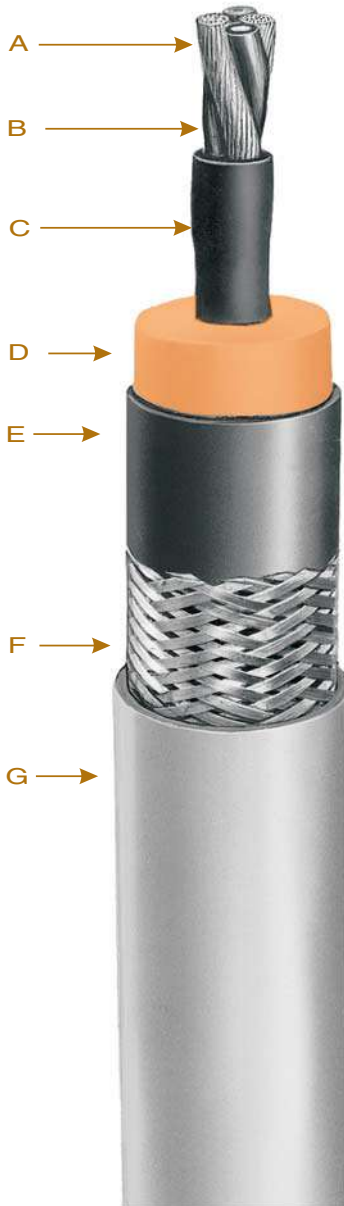

- A Coated Stranded Copper Conductors
- B Polyester Insulation
- C Extruded Semiconducting Layer
- D Primary Insulation – Okoguard
- E Extruded Insulation Shield
- F Coated Copper Braid
- G Jacket – Okoseal

Applications

Okonite X-Ray cables are suitable for use on X-Ray apparatus for medical, industrial, research and control applications. They give trouble-free performance where pulse type high voltages are required. Although primarily used with medical diagnostic imaging equipment, Okonite X-Ray cables are also used with equipment in industrial applications as well as in research projects where high voltages, low power are required.

Okonite LOW NOISE X-Ray cables have specifically been designed for use where sensitive measurements are required. These LOW NOISE cables are manufactured and assurance tested to meet less than 10 picocoulomb discharge thereby reducing noise to a minimum.

Okonite LOW NOISE X-Ray cables are offered at 65kV, 75kV, 100kV, 230kV and 250kV dc ratings.

Typically, Okonite X-Ray cables are used to supply the anode and cathode voltages to the X-Ray tube. Since one terminal operates at a negative potential and the other at a positive potential, the voltage across the X-Ray tube is twice (2X) the rated voltage of the cable.

The two usual constructions are (1) three conductor (3/C) used on typical cathode cable installations, and (2) four conductor (4/C) utilized on installations with a grid controlled lead. Upon request, designs and constructions can be developed for special applications.

Product Features

- Low Noise - < 10 pC @ 200 Vac/mil of insulation to 42 kV max.
- Performance tested for long trouble-free service.
- Small diameter.
- Flexible construction.
- Excellent flexing endurance.
- Mechanically rugged.
- Easy to strip and terminate.
- Resistant to most oils and chemicals.
- Complies with NEMA Standard XR-7 where applicable.

Installation

The minimum bending radius for permanent installation or flexing in service is four times the cable diameter.

Specifications

Cable Core: Each Low Noise cable core contains two insulated filament conductor. In 65, 75, and 100kV cable filament conductors are #15 AWG (19x) [1.65mm²] tinned copper insulated with heat sealed color coded polyester tape. In 230kV cables, the filament wires are #16 AWG (19x) [1.31mm²] tinned copper. The 250 kV cable filaments are #14 AWG (19x) [2.08mm²] tinned copper. Both the 230 and 250kV filament wires are insulated with an extrusion of ETFE. Four conductor cables include one #20 AWG (7x) [0.52mm²] copperweld conductor per ASTM B-45 insulated with heat sealed polyester and shielded with metalized red polyester.

The tinned copper uninsulated conductor in 3/C 65, 75, 100 and 230kV cables is segmented into two #18 AWG [0.83mm²] flex stranded wires. The 4/C uninsulated conductor is segmented into three #18 AWG wires. A single #12 AWG (19x) wire is used in the 250kV cable.

Core Shield: An extruded layer of semiconducting compound encapsulates the composite core assembly.

High Voltage Insulation: Okonite's premium EPR (ethylene-propylene rubber) insulation. This ozone resistant high voltage dielectric is extruded in tandem with the semiconducting layers which insures an intimate and contaminant free interface between the layers.

Insulation Shield: A strippable extruded layer of semiconducting EPR compound is applied directly over the insulation.

Shield: A braid of tinned copper wires is applied directly over the insulation shield. Minimum coverage indicated in table.

Jacket: A flexible Okoseal (specially compounded PVC) jacket is extruded over the shield to provide additional mechanical strength and resistance to most oils and chemicals.

Okonite X-Ray/Hi-Voltage Cable

Low Noise

65kV, 75kV, 100kV, 230kV and 250kV dc Rating

Three Conductor or Four Conductor

Product Data Section 6: Sheet 1

	Description	Catalog Number	Tinned Copper Braid Coverage (%)	Cellophane Wrap (1)	Jacket Color	Insulation O.D.		Insulation O.D.		Jacket O.D.		Jacket O.D.		Net. Wt. (lbs/1000 ft.)		Approx. Ship Weight (lbs./1000)		Approx. Ship Weight (kg./100m)	
						Inches ± 0.010	mm ± 0.25	Inches ± 0.015	mm ± 0.38	Net. Wt. (lbs/1000 ft.)	Net. Wt. (kg/100m)	Approx. Ship Weight (lbs./1000)	Approx. Ship Weight (kg./100m)						
65kV	3 Conductors 2-#15 AWG insulated 1-(2-#18 AWG) un-insulated	504-22-6436	80	yes	Gray	0.465	11.81	0.605	15.36	219	33	243	36						
		504-22-3437 504-22-3495	80 95	no	Gray	0.510	12.95	0.650	16.50	247 258	37 38	279 297	42 44						
75kV	3 Conductors 2-#15 AWG insulated 1-(2-#18 AWG) un-insulated	504-22-4464	80	no	Gray	0.570	14.48	0.715	18.20	296	44	335	50						
		4 Conductors 2-#15 AWG 1-#20 AWG Copperweld, insulated 1-(3-#18 AWG) un-insulated																	
75kV Extra Small Diameter	3 Conductors 2-#15 AWG insulated 1-(2-#18 AWG) un-insulated	504-22-3415	80	no	Gray	0.490	12.45	0.620	15.75	228	34	267	40						
100kV	3 Conductors 2-#15 AWG insulated 1-(2-#18 AWG) un-insulated	▲ 504-22-3436 ▲ 504-22-4437	80	no yes	Gray	0.620	15.75	0.785	19.94	341	51	380	57						
		4 Conductors 2-#15 AWG 1-#20 AWG Copperweld, insulated 1-(3#18 AWG) un-insulated	504-22-4436 504-22-4437	80	no yes	Gray	0.660	16.75	0.845	21.46	391	58	446	66					
230kV	3 Conductors 2-#16 AWG insulated 1-(2-#18 AWG) un-insulated	▲ 504-22-7410	80	no	Black	0.980 ±.020	24.89 ±.51	1.250 ±.025	31.75 ±.64	759	113	849	126						
250kV	3 Conductors 2-#14 AWG insulated 1-(#12 AWG) un-insulated	504-22-9430	80	no	Black	1.280 ±.020	32.51 ±.51	1.505 ±.025	38.23 ±.64	1119	167	1250	186						

▲ Authorized stock item. Available from our Customer Service Centers.

(1) Cable is helically wrapped with a cellophane tape to maintain cleanliness during installation and includes a pull cord for ease of removal.

- Designs for special applications upon request.

- Refer to Product Data Section 6 Sheet 1 for X-Ray Cable - Low Noise constructions.

Electrical Characteristics

Rated Voltage Rectified dc kV (2)	Number of Conductors	Core to Shield Capacitance ± 10%		4/C only: Copperweld grid lead capacitance = 70 pF/ft. (230 pF/m).	
		pF/ft.	pF/m	Conductor resistance @ 25°C:	
65	3	52	170	#16 AWG (1.31 mm ²) tinned copper = 4.18 ohms/1000 ft (1.37 ohms/100 m)	
75 (ESD)	3	49.5	162	#15 AWG (1.65 mm ²) tinned copper = 3.51 ohms/1000 ft (1.15 ohms/100 m)	
75	3	47	154	#18 AWG (0.83 mm ²) tinned copper = 7.16 ohms/1000 ft (2.34 ohms/100 m)	
75	4	57	187	2 X #18 AWG (0.83 mm ²) tinned copper = 3.58 ohms/1000 ft (1.17 ohms/100 m)	
100	3	40	131	3 X #18 AWG (0.83 mm ²) tinned copper = 2.39 ohms/1000 ft (0.78 ohms/100 m)	
100	4	49	159	#20 AWG (0.52 mm ²) copperweld = 24.12 ohms/1000 ft (7.91 ohms/100 m)	
230	3	35	115	#14 AWG (2.08 mm ²) tinned copper = 2.73 ohms/1000 ft (0.895 ohms/100 m)	
250	3	31	101	#12 AWG (3.31 mm ²) tinned copper = 1.72 ohms/1000 ft (0.564 ohms/100 m)	

(2) Voltage rating is between the conductor and the shielding braid.



Okonite X-Ray/Hi-Voltage Cable

65kV, 75kV and 100kV dc Rating
Three Conductor or Four Conductor

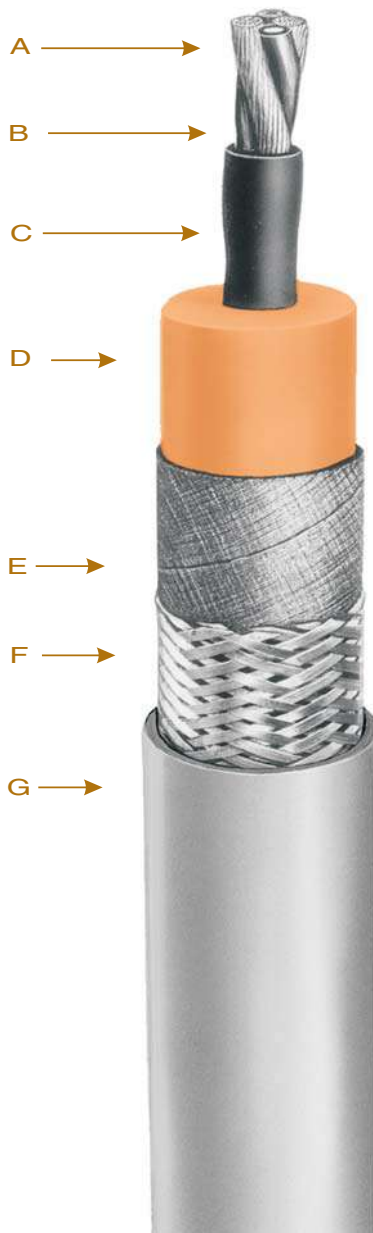

- A Coated Stranded Copper Conductors
- B Polyester Insulation
- C Extruded Semiconducting Layer
- D Insulation - Okoguard
- E Semiconducting Tape
- F Coated Copper Braid
- G Jacket - Okoseal

Applications

Okonite X-Ray cables are suitable for use on X-Ray apparatus for medical, industrial, research and control applications. They give trouble-free performance where pulse type high voltages are required. Although primarily used with medical diagnostic imaging equipment, Okonite X-Ray cables are also used with equipment in industrial applications as well as in research projects where high voltages, low power are required.

Typically, Okonite X-Ray cables are used to supply the anode and cathode voltages to the X-Ray tube. Since one terminal operates at a negative potential and the other at a positive potential, the voltage across the X-Ray tube is twice (2X) the rated voltage of the cable.

The two usual constructions are (1) three conductor (3/C) used on typical cathode cable installations, and (2) four conductor (4/C) utilized on installations with a grid controlled lead. Upon request, designs and constructions can be developed for special applications.

Product Features

- Performance tested for long trouble-free service.
- Small diameter.
- Flexible construction.
- Excellent flexing endurance.
- Mechanically rugged.
- Easy to strip and terminate.
- Resistant to most oils and chemicals.
- Complies with NEMA Standard XR-7 where applicable.

Installation

The minimum bending radius for permanent installation or flexing in service is four times the cable diameter.

Specifications

Cable Core: Each cable contains two #15 AWG (19x) [1.65mm²] tinned copper filament wires insulated with heat sealed color coded polyester tape. Three conductor cores include two uninsulated #18 AWG [0.83mm²] flex stranded tinned copper wires. Four conductor cables include one #20 AWG (7x)

[0.52mm²] copperweld conductor per ASTM - 45 insulated with heat sealed polyester and shielded with metalized red polyester. The four conductor core includes three uninsulated #18 AWG flex stranded tinned copper wires.

All conductors are twisted together into a composite assembly.

Core Shield: An extruded layer of semiconducting compound encapsulates the composite core assembly.

Insulation: Okonite's premium high voltage EPR (ethylene propylene rubber) insulation is extruded in tandem with the semiconducting compound ensuring an intimate contaminant free bond between the layers

Shield: A semiconducting tape is applied over the insulation with a tinned copper wire braid. Minimum coverage indicated in table.

Jacket: A light gray flexible Okoseal (specially compounded PVC) jacket is extruded over the shield to provide additional mechanical strength and resistance to most oils and chemicals.

Okonite X-Ray/Hi-Voltage Cable

65kV, 75kV, 100kV dc Rating

Three Conductor or Four Conductor

Product Data Section 6: Sheet 2

	Description	Catalog Number	#34 AWG T.C. Braid Coverage (%)	Cellophane Wrap (1)	Jacket Color	Insulation O.D. Inches ± 0.010	Insulation O.D. mm ± 0.25	Jacket O.D. Inches ± 0.015	Jacket O.D. mm ± 0.38	Net. Wt. (lbs/1000 ft.)	Net. Wt. (kg/100m)	Approx. Ship Weight (lbs/1000')	Approx. Ship Weight (kg/100m)
65kV	3 Conductors 2-#15 AWG insulated 1-(2-#18 AWG) un-insulated	504-22-6040	80	yes	Gray	0.465	11.81	0.605	15.40	219	33	252	38
		504-22-6041	80	no									
75kV	3 Conductors 2-#15 AWG insulated 1-(2-#18 AWG) un-insulated	▲ 504-22-3165	80	yes	Gray	0.510	12.95	0.650	16.50	236	35	273	41
		504-22-3164	80	no						236	35	273	41
		504-22-3836	95	yes						248	37	278	42
75kV	4 Conductors 2-#15 AWG insulated 1-#20 AWG Copperweld, insulated 1-(3-#18 AWG) un-insulated	504-22-2164	80	no	Gray	0.570	14.48	0.715	18.20	289	43	333	50
75kV Extra Small Diameter	3 Conductors 2-#15 AWG insulated 1-(2-#18 AWG) un-insulated	▲ 504-22-3015	80	no	Gray	0.490	12.45	0.600	15.25	224	34	248	37
100kV	3 Conductors 2-#15 AWG insulated 1-(2-#18 AWG) un-insulated	504-22-1033	80	no	Gray	0.620	15.75	0.785	19.90	332	49	371	55
		504-22-1035	80	yes									
100kV	4 Conductors 2-#15 AWG insulated 1-(#20 AWG) Copperweld, insulated 1-(3-#18 AWG) un-insulated	504-22-2041	80	no	Gray	0.660	16.75	0.845	21.50	380	57	441	66

▲ **Authorized stock item.** Available from our Customer Service Centers.

(1) Cable is helically wrapped with a cellophane tape to maintain cleanliness during installation and includes a pull cord for ease of removal.

- Designs for special applications upon request.

- Refer to Product Data Section 6 Sheet 1 for X-Ray Cable - Low Noise constructions.

Electrical Characteristics

Rated Voltage Rectified dc kV (2)	Number of Conductors	Core to Shield Capacitance ± 10%		4/C only: Copperweld grid lead capacitance = 70 pF/ft. (230 pF/m).
		pF/ft.	pF/m	
65	3	52	170	Conductor resistance @ 25°C: #16 AWG (1.31 mm ²) tinned copper = 4.18 ohms/1000 ft (1.37 ohms/100 m) #15 AWG (1.65 mm ²) tinned copper = 3.51 ohms/1000 ft (1.15 ohms/100 m) #18 AWG (0.83 mm ²) tinned copper = 7.16 ohms/1000 ft (2.34 ohms/100 m) 2 X #18 AWG (0.83 mm ²) tinned copper = 3.58 ohms/1000 ft (1.17 ohms/100 m) 3 X #18 AWG (0.83 mm ²) tinned copper = 2.39 ohms/1000 ft (0.78 ohms/100 m) #20 AWG (0.52 mm ²) copperweld = 24.12 ohms/1000 ft (7.91 ohms/100 m)
75 (ESD)	3	49.5	162	
75	3	47	154	
75	4	57	187	
100	3	40	131	
100	4	49	159	
160	3	35	115	
250	3	31	101	

(2) Voltage rating is between the conductor and the shielding braid.



Okoguard® Aerial Jumper Cable

15kV - 90°C Rating



- A Coated, Stranded Copper Conductor
- B Strand Screen
- C Insulation/Jacket-Okoguard

Insulation/Jacket

Okoguard is Okonite's registered trade name for its exclusive ethylene-propylene base, thermosetting compound, whose optimum balance of electrical and physical properties is unequalled in other solid dielectrics.

This durable Okoguard insulation serves as a jacket as well and has a natural, highly visible, orange color.

Applications

Okoguard Portable Jumper cables are designed as flexible power leads for use with tap-off or jumper clamps which permit temporary connections or "by-pass" of energized aerial lines operating at voltages up to and including 15000V (phase to phase).

Specifications

Power Conductors: Flexible rope lay strand, tin coated copper per ASTM B-33 and B-172.

Conductor Screen: A helically applied semiconducting tape, whose purpose is to improve service life, dielectric strength and eliminate internal corona.

Insulation: Heat, moisture and ozone resistant 90°C Okoguard Insulation/Jacket.

Product Features

- Extra-flexible conductors for ease of handling under adverse conditions.
- Conductor screen for improved voltage stress control.
- Heat, moisture and ozone resistant 90°C Okoguard Insulation/Jacket.
- Okoguard is orange for visual attention and it has good color stability even when exposed to strong sunlight.
- Excellent low temperature properties.
- Okoguard non-shielded cable is 15kV rated and is not UL listed.

Okoguard Aerial Jumper Cable

15kV - 90°C Rating

Product Data

Section 6: Sheet 4

Catalog Number	Conductor Size AWG	Min. No. Strands	Nominal Cdr. Diameter - Inches	Approx. O.D. - Inches	Approx. O.D. - mm	Approx. Net Weight (lbs./1000')	Approx. Ship Weight (lbs./1000')	Amps Per Cdr.
15kV - Okoguard Insulation: #2 AWG Through #4/0 AWG, 210 mils								
▲ 303-21-1934	2	259	0.319	0.780	19.8	425	480	192
▲ 303-21-1938	1/0	259	0.408	0.863	22.0	583	638	258
▲ 303-21-1940	2/0	259	0.450	0.910	23.3	687	752	298
▲ 303-21-1944	4/0	437	0.592	1.052	27.2	997	1092	400

▲ **Authorized Stock Item.** Available from our Customer Service Centers

Minimum Order Quantity is 150 ft.

Standard Package —1000' N.R. Reel. Standard package will be furnished where orders do not specify otherwise.

Ampacities

Ampacity based on 90°C conductor temperature, 40°C ambient temperature.
For ampacity correction factors covering various ambient temperatures:

Ambient Temperature Degrees		Correction Factor
C	F	
10	50	1.26
20	68	1.18
30	86	1.10
40	104	1.00
50	122	0.90



Okoguard®-Okolon® TS-CPE 5kV Airport Lighting Cable*

FAA-L-824 Type B

One Okopact (Compact Stranded) Copper Conductor/90°C Rating Wet or Dry

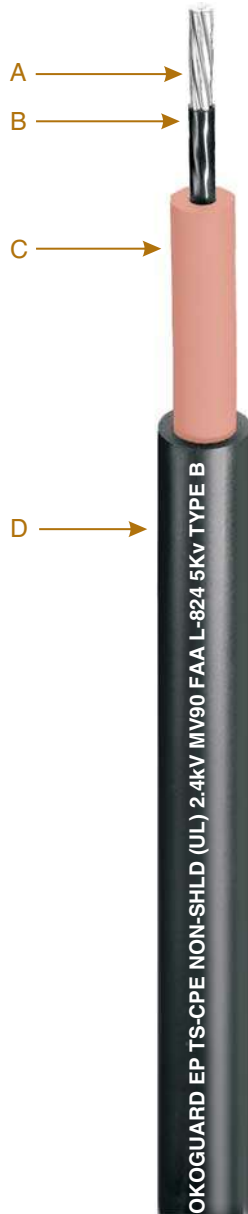

- A Uncoated, Okopact (Compact Stranded) Copper Conductor
- B Strand Screen-Extruded Semiconducting EPR
- C Insulation-Okoguard EPR
- D Jacket-Okolon TS-CPE

Insulation

Okoguard is Okonite's registered trade name for its exclusive medium voltage grade ethylene-propylene rubber (EPR) based, thermosetting compound, whose optimum balance of electrical and physical properties is unequalled in other solid dielectrics.

Okoguard insulation, with the distinctive red color and a totally integrated EPR system, provides the optimum balance for long, problem free service.

Jacket

The Okolon TS-CPE jacket on this cable is a vulcanized chlorinated polyethylene based compound which is mechanically rugged, flame, and oil resistant.

Applications

Okoguard-Okolon TS-CPE cables are heavy duty nonshielded cables designed for use at up to 5kV in wet or dry airport lighting applications.

Okoguard-Okolon TS-CPE nonshielded airport lighting cables are recommended for use in series lighting circuits for runways and control systems. Cables can be installed in metallic or non-metallic conduit, directly buried or aerial application.

Specifications

Meets or exceeds the requirements of FAA Advisory Circular AC 150/5345-7F.

Conductor: Annealed uncoated copper compact Class B stranded per ASTM B-496.

Strand Screen: Extruded semiconducting EPR strand screen. Meets or exceeds electrical and physical requirements of ICEA S-96-659/NEMA WC71.

Insulation: Meets or exceeds electrical and physical requirements of ICEA S-96-659/NEMA WC71. Insulation thickness per Table 4-3 for wet or dry applications.

Jacket: Meets or exceeds electrical and physical requirements of ICEA S-96-659/NEMA WC71 for chlorinated polyethylene jackets.

Product Features

- Resistant to runway and wing de-icers
- 90°C Continuous Rating, 130°C Emergency Overload Rating, 250°C Short Circuit Rating
- Exceptional resistance to surface tracking
- Superior Flexibility
- Constructed for "wet" location applications
- Excellent corona resistance
- Stress cones not required
- Resistant to most oils, acids, and alkalies

*Applications governed by the National Electrical Code limit non-shielded cable to 2.4kV

Catalog Number	Conductor** Size		Insulation Thickness		Jacket Thickness		Approx. O.D.		Approx. Net Wt. Lbs./1000'	Approx. Ship Wt. Lbs./1000'
	AWG	mm ²	mils	mm	mils	mm	inches	mm		
▲ 114-24-2213	8	8.4	125	3.18	80	2.03	0.60	15.1	215	250
▲ 114-24-2217	6	13.3	125	3.18	80	2.03	0.63	16.0	260	295
▲ 114-24-2219	4	21.2	125	3.18	80	2.03	0.67	17.1	328	368

▲ **Authorized stock item.** Available from our Customer Service Centers.

**Class C stranded conductors are available.





Okonite® Armored Underground Signal Cables

With P.C.F. (Pull Cord Feature)

Heavy Duty Direct Burial Railroad Signal Cable

— AREMA Type 1 EPR Insulation — 600V

Multiple Copper Conductors/90°C Rating

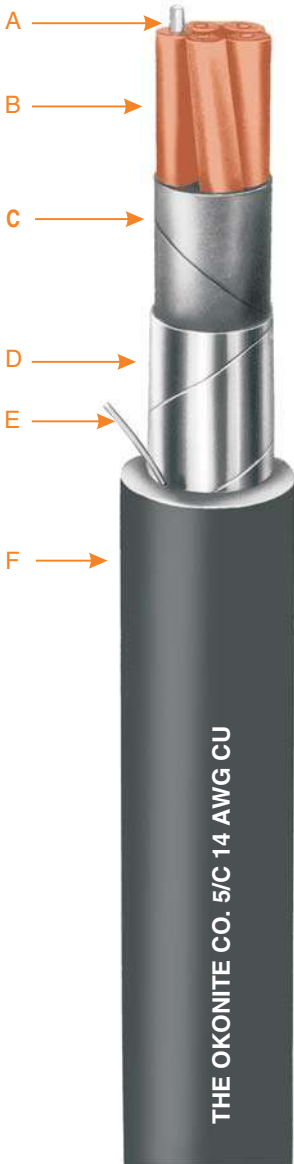

- A Solid or Stranded Uncoated Copper Conductors
- B Insulation—Okonite #14 AWG-#9 AWG 5/64", #6 - #2 AWG 6/64" with printed number code and tracer
- C Cushion Tape Layer
- D Flat Copper Alloy Armor Tape
- E Pull Cord
- F Jacket—Okolene with sequential footage marking

Insulation

Okonite EPR insulation is a heat, moisture and chemical resistant, mechanically rugged compound. The insulation thickness for size #14 AWG through #9 AWG is 5/64" and for #6 AWG through #2 AWG is 6/64". One conductor in each layer is identified as "Tracer". In addition, each conductor is number coded for ease of identification.

Assembly and Finish

Individual conductors are assembled with suitable fillers, where necessary, and a cable cushioning tape. A 7 mil flat copper alloy tape is then helically applied, giving outstanding mechanical protection. The black Okolene® (polyethylene) jacket is then applied overall.

Applications

Okonite Armored Underground Signal Cables are designed for use in all vital railroad signal circuits where security of service and long life are required in all vital circuit and safety related applications. These cables are recommended for use where crush resistance, termite and rodent protection are considerations and in all wet and dry locations.

Specifications

AREMA Signal Manual Part 10.3.17

Conductors: Solid uncoated copper per ASTM B-3, stranded uncoated compact round copper per ASTM B-496.

Insulation: Meets or exceeds electrical and physical requirements of ICEA S-95-658 (NEMA WC70) and AREMA Manual Part 10.3.19, thickness per table 10317-4.

Armor Tape: Copper alloy C19400 per ASTM B-465.

Jacket: Meets or exceeds electrical and physical requirements of ICEA S-95-658, Part 4.1.5.

Product Features

- Mechanically rugged.
- Resistant to aging.
- Easy to install and splice.
- Resistant to environmental hazards.
- Superior moisture resistance.
- Outstanding termite and rodent protection.
- Excellent electrical properties... high dielectric strength, low SIC and power factor and high insulation resistance.
- The Pull Cord feature affords easy and quick accessibility to conductors for splicing and terminating.
- Sequential footage markings on surface of outer jacket.

COMPOSITE CONSTRUCTIONS

Okonite Insulation: #14 AWG through #9 AWG 5/64", #6 AWG 6/64"

Catalog Number	Composite Make-Up	Conductors No. x Size (# Strands)	Conductors No. x Size (# Strands)	Outer Jacket Thickness 64th	Approx Cable O.D. (In.)	Approx Net Wt. Lbs./M'	Approx Ship Wt. Lbs./M
206-11-8974	7/C	2 x 9 (1X)	5 x 14 (1X)	5	0.99	523	574
▲ 206-11-8255	15/C	3 x 6 (1X)	12 x 14 (1X)	6	1.48	1145	1273
▲ 206-11-6283	19/C	6 x 6 (1X)	13 x 14 (1X)	6	1.69	1674	1877

▲ **Authorized Stock Item** - Available from Customer Service Centers.

Composite Cable Constructions are also available with stranded conductors. Consult your Okonite Representative.

Okonite Armored Underground Signal Cables

Product Data Section 7: Sheet 1

Okonite Insulation: #14 AWG Through #9 AWG, 5/64", #6 through #2 AWG, 6/64"

Catalog Number	Size AWG	No. of Strands (1)	No. Condrs.	Outer Jacket Thickness-64th	Approx. Cable O.D. Inches	Net Wt. Lbs./M'	Approx. Ship Wt. Lbs./M'
▲ 206-11-6882	14	Sol.	2	4	.63	184	241
206-11-6883	14	Sol.	3	4	.67	220	286
206-11-6884	14	Sol.	4	4	.73	267	338
▲ 206-11-6885	14	Sol.	5	4	.79	314	408
▲ 206-11-6887	14	Sol.	7	5	.89	409	510
206-11-6889	14	Sol.	9	5	1.03	526	671
206-11-6890	14	Sol.	10	5	1.10	583	790
▲ 206-11-6892	14	Sol.	12	5	1.16	649	792
206-11-6895	14	Sol.	15	6	1.31	804	994
206-11-6896	14	Sol.	16	6	1.31	928	1029
▲ 206-11-6899	14	Sol.	19	6	1.38	959	1151
206-11-6901	14	Sol.	21	6	1.45	1050	1250
▲ 206-11-6907	14	Sol.	27	6	1.65	1308	1638
▲ 206-11-6910	14	Sol.	37	7	1.87	1735	2076
206-11-6692	12	Sol.	2	4	.66	206	273
206-11-6693	12	Sol.	3	4	.70	256	330
206-11-6694	12	Sol.	4	4	.76	313	392
206-11-6695	12	Sol.	5	4	.83	368	471
206-11-6697	12	Sol.	7	5	.94	487	594
206-11-6699	12	Sol.	9	5	1.09	625	781
206-11-6700	12	Sol.	10	5	1.16	699	866
206-11-6702	12	Sol.	12	5	1.26	804	952
206-11-6812	10	Sol.	2	4	.70	244	317
206-11-6813	10	Sol.	3	4	.75	311	384
206-11-6814	10	Sol.	4	4	.82	383	483
206-11-6815	10	Sol.	5	5	.92	479	577
206-11-6817	10	Sol.	7	5	1.00	611	746
206-11-6819	10	Sol.	9	5	1.17	772	934
206-11-6820	10	Sol.	10	6	1.25	872	1078
206-11-6822	10	Sol.	12	6	1.35	1007	1199
206-11-6922	9	Sol.	2	4	.73	283	350
▲ 206-11-6923	9	Sol.	3	4	.77	351	443
206-11-6924	9	Sol.	4	5	.88	452	554
▲ 206-11-6925	9	Sol.	5	5	.96	549	640
▲ 206-11-6927	9	Sol.	7	5	1.04	686	829
206-11-6928	9	Sol.	8	5	1.13	775	935
206-11-6929	9	Sol.	9	5	1.23	901	1057
▲ 206-11-6930	9	Sol.	10	6	1.33	1052	1221
206-11-6931	9	Sol.	12	6	1.40	1161	1338
▲ 206-11-6242	6	Sol.	2	5	0.93	457	564
▲ 206-11-6243	6	Sol.	3	5	0.97	591	724
206-11-6244	6	Sol.	4	5	1.08	730	881
▲ 206-11-6245	6	Sol.	5	5	1.18	913	1044
▲ 206-11-6247	6	Sol.	7	6	1.32	1193	1368
206-11-6248	6	Sol.	8	6	1.43	1351	1552
▲ 206-11-6249	6	Sol.	9	6	1.54	1532	1820
▲ 206-11-6070*	6	7	3*	5	1.04	671	753
▲ 206-11-6374	6	7	4*	6	1.13	829	896
▲ 206-11-6042	4	7	2	5	1.03	606	674
▲ 206-11-6373	4	7	3	5	1.10	801	894
▲ 206-11-6045	4	7	5	6	1.18	911	1356
▲ 206-11-6130**	2	7	3**	6	1.25	1191	1346

Minimum Manufacturing Quantity is 1000 ft. Standard Package—1000' N.R. Reel.

▲ Authorized Stock Item - Available from Customer Service Centers.

(1) This construction is also available with stranded conductors. Consult your Okonite Representative.

* Includes 1 #8 AWG Class B Ground

** Includes 1 #6 AWG Class B Ground



Okonite®-Okolene® Duplex Track Wire 600V

One Copper Conductor/90°C Rating



A Solid Uncoated Copper Conductors
B Insulation - Okonite-Sizes #9 AWG and #8 AWG-5/64", #6 AWG-6/64"
C Jacket-Okolene, Color Coded; 1-Black, 1-Red

Insulation

Okonite EPR is Okonite's trade name for its heat resistant, mechanically rugged ethylene-propylene based insulating compound. The insulation thickness for wire sizes #9 AWG is 5/64" and for #6 AWG is 6/64".

Jackets and Finishes

The Okolene (PE) jacket supplied with this cable provides excellent resistance to mechanical abuse, weathering and most acids, oils and alkalis. Color Coded; 1-Black, 1-Red.

Applications

Okonite-Okolene 600V Duplex Track Wire is recommended for use in track circuits, signal operations, car retarder and switch machine applications. Can be installed in either wet or dry locations, in conduit trays or trough or buried direct.

Specifications

Conductor: Solid uncoated copper per ASTM B-3.

Insulation: Per ICEA S-95-658, and AREMA Signal Manual Part 10.3.19.

Jacket: Meets or exceeds the physical and electrical requirements of ICEA S-95-658, and AREMA Signal Manual Part 10.3.21

Product Features

- Exceptional heat resistance.
- 90°C Continuous Rating
130°C Emergency Overload Rating.
250°C Short Circuit Rating.
- Mechanically rugged.
- Flexible, easy to handle and splice.
- Resistant to most oils, acids, alkalis and effects of weather.
- Stable electrical and physical properties.
- Excellent moisture resistance.

Okonite Insulation: #9 AWG, 5/64", #6 AWG, 6/64"

Catalog Number	Size AWG	No. of Strands	Jacket Thickness 64 th's	Approx. Duplexed O.D. (In.)	Approx. Net Wt. Lbs./M'	Approx. Ship Wt. Lbs./M'
150-12-3931	9	Solid	4	0.83"	199	243
▲ 150-12-3933	6	Solid	4	1.00"	329	404

▲ Authorized Stock Item: Available from our Customer Service Center

Standard Package -1000' Non-Returnable Reel





Okonite® TC Blue Tower and Case Wire

600 Volt

One Copper Conductor/90°C Rating



- A Uncoated, Stranded Copper Conductor
- B Insulation—Okonite
- C Jacket—Blue Okoseal

Insulation

Okonite EPR is Okonite's trade name for its heat resistant, mechanically rugged ethylene-propylene based insulating compound. The insulation thickness for wire sizes are listed below.

Jackets and Finishes

The Blue Okoseal® (PVC) jacket supplied with this cable provides excellent resistance to mechanical abuse, flame, weathering, and most acids, oils, and alkalis.

Applications

Okonite Tower and Case Wire is recommended for use as relay and associated signal apparatus wiring and for connector wire use where a flexible, small diameter wire is required.

Specifications

Conductor: Uncoated stranded copper stranded per ASTM B-8.

Insulation: Per ICEA S-95-658. Meets or exceeds all requirements for EPR insulation.

Jacket: Per ICEA S-95-658. Meets or exceeds all requirements.

Okonite Tower and Case Wire meets or exceeds the requirements of AREMA Manual Part 10.3.15.

Product Features

- Exceptional heat resistance.
- 90°C Continuous Rating
130°C Emergency Overload Rating.
250°C Short Circuit Rating.
- Mechanically rugged.
- Flexible, easy to handle and splice.
- Flame resistant—meets U.L. horizontal flame test.
- Resistant to most oils acids, alkalis and effects of weather.
- Stable electrical and physical properties.

Catalog Number	Size AWG	No. of Strands	Insulation Thickness Mils	Jacket Thickness Mils	Approx. O.D. (In.)	Approx. Net Wt. Lbs./m'	Approx. Ship Wt. Lbs./m'
▲ 152-11-3002	16	19	30	20	.17	20	24
▲ 152-11-3024	14	19	30	20	.20	26	28
152-11-3026	12	19	45	20	.23	42	46
▲ 152-11-3038	10	19	30	20	.23	56	60
152-11-3108	10	37	45	20	.26	58	62
152-11-3010	9	19	45	25	.29	71	75
▲ 152-11-3015	6	19	60	30	.37	130	143

▲ **Authorized Stock Item** - Available from our Customer Service Centers.

Note: The construction described has a Blue Jacket. Consult your local Okonite Representative for details about alternate colors.

Standard Package - #16 AWG and #14 AWG, 1,000 spool; #12 AWG, #10 AWG, and #9 AWG, 500' spool.



Okonite® Okolon® - (TS-CPE) Case Wire 600V

One Copper Conductor/90°C Rating



- A Uncoated, Stranded Copper Conductor
- B Insulation—Okonite—#16 AWG and #14 AWG - 2/64"; #12 AWG thru #6 AWG - 3/64"
- C Jacket - Okolon TS-CPE

Insulation

Okonite EPR is Okonite's trade name for its heat resistant, mechanically rugged ethylene-propylene based insulating compound. The insulation thickness for wire size #16 AWG and #14 AWG is 2/64" and for #12 AWG and #10 AWG it is 3/64".

Jackets and Finishes

The Okolon (TS-CPE) jacket supplied with this cable provides excellent resistance to mechanical abuse, flame, weathering and most acids, oils and alkalies.

Applications

Okonite Okolon (TS-CPE) 600V Case Wire is recommended for use as relay and associated signal apparatus wiring and for connector wire use where a flexible, small diameter wire is required.

Specifications

Conductor: Uncoated Class C stranded copper per ASTM B-8.

Insulation: Per ICEA S-95-658 and AREMA Signal Manual Part 10.3.15.

Jacket: Per ICEA S-95-658, ICEA S-95-658, Part 4.1.13 and 4.1.3.

Product Features

- Exceptional heat resistance.
- 90°C Continuous Rating
130°C Emergency Overload Rating.
250°C Short Circuit Rating.
- Mechanically rugged.
- Flexible, easy to handle and splice.
- Flame resistant — meets U.L. horizontal flame test.
- Resistant to most oils, acids, alkalies and effects of weather.
- Stable electrical and physical properties.

Okonite Insulation: #16 AWG and #14 AWG - 2/64"; #12 AWG to #6 AWG - 3/64"

Catalog Number	Size AWG	No. of Strands	Jacket Thickness 64 th's	Approx. O.D. (In.)	Approx. Net Wt. Lbs./M'	Approx. Ship Wt. Lbs./M'
151-12-1051	16	19	1	.16	20	24
▲ 151-12-1081	14	19	1	.18	26	30
151-12-1101	12	19	1	.23	42	46
151-12-1140	10	19	1	.25	58	62
151-12-1171	9	19	1	.26	67	75
▲ 151-12-1201	6	19	1	.31	112	122

▲ Authorized Stock Item - Available from Customer Service Centers.

Standard Package — #16 AWG and #14 AWG, 1000' spool; #12 AWG thru #6 AWG, 500' spool.



Okonite®-Nylon Braid Case Wire

600V

One Copper Conductor/90°C Rating



A Uncoated, Stranded Copper Conductor
B Insulation—Okonite #16 and #14 AWG 2/64"; #12 AWG through #9 AWG 3/64"
C Finish—Nylon Braid with Lacquer Overall

Insulation

Okonite EPR is Okonite's trade name for its heat resistant, mechanically rugged ethylene-propylene based insulating compound. The insulation thickness for wire sizes #16 AWG and #14 AWG is 2/64" and for #12 AWG through #9 AWG it is 3/64".

Finish

The nylon braid and lacquer finish supplied with this cable provides excellent resistance to mechanical abuse, weathering and most oils, acids and alkalis.

Applications

Okonite-Nylon Braid 600V Case Wire is recommended for use as relay and associated signal apparatus wiring, and for connector wire use where a flexible, small diameter wire is required.

Specifications

Conductor: Uncoated, Class C or D stranded copper conductor per ASTM B-8.

Insulation: Per ICEA S-95-658 and AREMA Signal Manual Part 10.3.15.

Finish: Black or Red nylon braid (100% coverage) with clear lacquer finish.

Product Features

- Mechanically rugged.
- 90°C Continuous Rating
130°C Emergency Overload Rating.
250°C Short Circuit Rating.
- Mechanically rugged.
- Flexible, easy to handle and splice.
- Resists most oils, acids, alkalis and effects of weather.
- Stable electrical and physical properties.

Nominal Finish Thickness: 9 mils

Catalog Number	Size AWG	No. of Strands	Insulation Thickness 64 th's	Approx. O.D. (In.)	Approx. Net Wt. Lbs./M'	Approx. Ship Wt. Lbs./M'
▲ 151-12-9051	16	19	2	.14	16	20
151-12-9081	14	19	2	.15	22	26
▲ 151-12-9111	12	19	3	.20	38	42
151-12-9145	10	19	3	.22	50	54
▲ 151-12-9161	10	37	3	.23	51	55
151-12-9181	9	19	3	.24	62	66
▲ 151-12-9053*	16	19	2	.14	16	21
▲ 151-12-9163*	10	37	3	.23	50	55

▲ **Authorized Stock Item** — Available from our Customer Service Centers

Standard Package — #16 AWG and #14 AWG, 1000' spool;
#12 AWG, #10 AWG, and #9 AWG, 500' spool.

*Red Nylon Braid





Type DEL

600-2000V Diesel-Electric Locomotive, Motor Traction and Car Wire

One Copper Conductor/90°C — 110°C Hot Spot Rating



- A Coated Stranded Copper Conductor
- B Separator (sizes 36,700 CM and larger)
- C Insulation - Okonite
- D Jacket - Okolon TS-CPE

Insulation

Okonite EPR® is Okonite's trade name for its heat resistant, mechanically rugged ethylene-propylene based insulating compound. The insulation thickness for DEL numbers 002 and 004 is 2/64", for 008 through 016 is 3/64", 018 through 026 is 4/64", 030 through 040 is 5/64", 044 and 048 is 6/64", 050 through 056 is 7/64" and for 058 it is 8/64".

Jackets and Finishes

The Okolon® TS-CPE jacket supplied with this cable provides excellent resistance to mechanical abuse, flame, weathering, most oils, acids and alkalis.

Applications

Okonite Type DEL, Diesel-Electric Locomotive Traction and Car Wires is designed for use in locomotives and car equipment circuits where reliability is for prime consideration. DEL can also be used in other low voltage applications where flexibility is important. It is suitable for use in wet or dry locations, in conduits, ducts, cable troughs or trays.

Specifications

Conductor: Coated copper stranded per AREMA Recommended Practice, Section M, RP-588, as applicable and ICEA S-95-658.

Insulation: Per AREMA Recommended Practice, Section M, RP-588, as applicable and ICEA S-95-658.

Jacket: Per AREMA Recommended Practice, Section M, RP-588, as applicable and ICEA S-95-658.

Product Features

- Extreme heat resistance.
- Extra flexible conductor.
- 90°C Continuous Rating, 110°C Hot Spot Rating, 130°C emergency Overload Rating, 300°C Short Circuit Rating.
- Mechanically rugged.
- Exceptional resistance to deformation and cut through at high temperature.
- Excellent flame resistance. Meets both UL vertical and horizontal flame test requirements.
- Resistant to oils, weather and most chemicals and alkalis.
- Stable electrical properties at high temperatures.
- Meets the RHH/RHW requirements of NEC/UL and can be labeled as such on special orders.

Type DEL

600-2000V Diesel - Electric Locomotive, Motor Traction and Car Wire

One Copper Conductor/90°C - 110°C Hot Spot Rating

Product Data Section 7: Sheet 17

Catalog Number	DEL Number	Size AWG or MCM	No. of Strands	Thickness 64ths		Voltage Rating	Approx. O.D. In.	Approx. Wt. Lbs./M'		Ampacity AC or DC		Conduit Size Inches ³	DC Resis @ 25°C ohms/1000'
				Ins.	Jkt.			Net	Ship	1/C in Air ¹	3-1/C in Duct ²		
▲ 112-11-1702	002	16	19 X .0117	2	1	600	.16	19	23	24	18	1/2"	4.490
112-11-1704	004	14	19 X .0142	2	1	600	.17	25	28	33	24	1/2"	2.790
112-11-1708	008	14	19 X .0147	3	1	2000	.21	31	35	33	24	1/2"	2.790
112-11-1710	010	12	19 X .0179	3	1	2000	.23	43	44	39	29	1/2"	1.720
▲ 112-11-1714	014	10	27 X .0201	3	1	2000	.26	61	60	57	41	3/4"	1.100
112-11-1716	016	8	37 X .0201	3	1	2000	.28	79	78	74	51	3/4"	0.690
112-11-1718	018	6	61 X .0201	4	2	2000	.41	144	141	101	72	1"	0.440
112-11-1720	020	5	91 X .0201	4	2	2000	.44	182	200	129	89	1 1/4"	0.350
112-11-1722	022	4	105 X .0201	4	2	2000	.46	204	222	142	95	1 1/4"	0.280
112-11-1724	024	3	125 X .0201	4	2	2000	.49	242	241	160	111	1 1/4"	0.220
112-11-1726	026	2	150 X .0201	4	2	2000	.55	285	298	180	124	1 1/2"	0.180
112-11-1730	030	1	225 X .0201	5	3	2000	.69	445	497	233	153	2"	0.140
112-11-1732	032	1/0	275 X .0201	5	3	2000	.72	492	550	268	175	2"	0.110
112-11-1734	034	2/0	325 X .0201	5	3	2000	.76	594	633	297	193	2"	0.090
112-11-1738	038	3/0	450 X .0201	5	3	2000	.86	786	842	367	236	2 1/2"	0.070
112-11-1740	040	4/0	550 X .0201	5	3	2000	.89	926	985	419	268	2 1/2"	0.060
112-11-1744	044	313.1	775 X .0201	6	3	2000	1.06	1289	1371	518	328	3"	0.040
112-11-1748	048	444.4	1100 X .0201	6	3	2000	1.20	1707	1830	653	402	3 1/2"	0.030
112-11-1750	050	535.3	1332 X .0201	7	4	2000	1.35	2141	2263	728	446	4"	0.020
112-11-1752	052	646.4	1600 X .0201	7	4	2000	1.44	2545	2700	813	496	4"	0.018
112-11-1754	054	777.7	1925 X .0201	7	4	2000	1.53	2842	3148	904	546	5"	0.016
112-11-1756	056	929.2	2300 X .0201	7	4	2000	1.62	3516	3560	1002	594	5"	0.013
112-11-1758	058	1111.1	2750 X .0201	8	4	2000	1.79	4208	4072	1119	637	5"	0.011

▲ **Authorized Stock Item** - Available from Customer Service Centers.

Standard Package - 1000' Non-Returnable Reel; #16 #8 - 1000' coil in carton; # 6 - 500' coil in carton; #5 - #4/0 - 2000' N.R. Reel; #313.1 MCM and Larger - 1000' N.R. Reel

¹ Ampacities based on single insulated conductor in free air, 90°C conductor temperature, 30°C ambient air temperature per NEC Table 310.17.

² Ampacities based on three (3) insulated conductors in a single enclosed or exposed conduit with 90°C conductor temperature and 30°C ambient air temperature per NEC Table 310.16. For other ambient temperatures refer to NEC Table 310.15(B)(1).

³ Based on three (3) conductors in conduit with a fill of 40% or less.



C-L-X Terminating Tool Kit



C-L-X TERMINATING TOOL KIT CONTENTS

- | | |
|--|---------------------------|
| 1 Cable Slitting Saw | 1 5/16" x 11" Screwdriver |
| 1 Small Cable Guide | 1 Cable Knife, 4" blade |
| 12 2" dia. High Speed Steel Saw Blades | 1 Hacksaw Blade Holder |
| 1 Tubing Cutter | 3 10" Hacksaw Blades |
| 1 Channel Lock Pliers | 1 Tool Case |
| 1 10' Retractable Tape | 1 Padlock with 2 keys |

PACKAGING

Catalog Number	Description	Net Weight (lbs.)	Shipping Weight (lbs.)
C-L-X Terminating Tool Kit			
▲ 606-01-1026	Electric - 120 Volt ac	20	21
▲ 606-01-1526	Pneumatic - 90psi	20	21
Cable Slitting Saw, Small Cable Guide and 12 High Speed steel saw Blades			
▲ 606-01-0026	Electric - 120 Volt ac	19	20
▲ 606-01-0526	Pneumatic - 90psi	19	20
12 High Speed Steel Saw Blades			
▲ 606-01-5754	2" diameter, 7 teeth per inch, packaged in a round tin container	1	1

▲ Authorized Stock Item

Applications

The C-L-X Terminating Tool Kit contains all the tools required to remove the overall jacket and aluminum sheath from C-L-X power, control, and instrumentation cables. The Cable Slitting Saw may also be used on interlocked armor and lead sheathed cables. The Cable Slitting Saw provides a simple and efficient means of removing the aluminum C-L-X sheath. It is available in either an electric or a pneumatic model. Both models have a retractable blade guard to protect the user.

The electric model is powered by a 2500 rpm, 120 Volt ac double insulated motor.

The lightweight pneumatic model is powered by a 2200 rpm motor which requires 90 psi of air pressure for maximum efficiency. The Small Cable Guide keeps the saw centered on the cable when slitting cables of 1" diameter or less.

The High Speed Steel Saw Blades provide a smooth cut in the aluminum sheath and have a cutting depth of 3/8" without the cable guide.

Removing the C-L-X Armor

This procedure applies to all types of C-L-X armor - aluminum, copper, bronze and stainless steel. Safe working practices are to be observed, e.g., safety glasses and work gloves. Practice sessions are recommended to familiarize all concerned with the procedures and equipment.

1. Remove the jacket to expose the desired length of un-armored cable within the enclosure.

2. Refer to the C-L-X fitting instructions for the length of C-L-X armor to be exposed beyond the end of the jacket and mark the C-L-X armor at the top of the crown nearest to that point.

- For C-L-X Diameters 1 5/8" and Smaller, Go To Steps 10 through 12.

- For C-L-X Diameters greater than 1 5/8" Follow Steps 3. Through 9.

C-L-X Terminating Tool Kit

3. First the C-L-X armor will be circumferentially cut using a hacksaw blade, (note the C-L-X saw tool kit is supplied with a hacksaw blade and blade holder) cut through the crown (high point) of the C-L-X at an angle so as to connect (or bridge) the valleys (low points) on both sides of the crown.
4. Again using a hacksaw blade, make a circumferential score in the valleys adjacent to the cut crown connecting both sides of the crown cut to the valleys. Do not cut through armor in valleys.
5. Holding the score area rigid, flex the cable by moving the free end so as to break the score around the circumference of the cable.
6. Next the C-L-X will be longitudinally cut by performing the following:

Note on the C-L-X Saw - The longitudinal cut is made with the C-L-X saw, which has an adjustable positive depth stop that can be set so the saw blade cuts through the crowns and partially cuts through the valleys. A proper saw depth is achieved when 80 to 95 % of the metal in the valley is removed. Use an extra piece of the cable being terminated to adjust the blade depth and practice.



Set blade to remove 80 to 95% of the metal thickness in the valley.

7. With cable secured, start at the free end of the cable and advance the Kett saw, making sure to use slight downward pressure to maintain the depth of cut along the cable, to the ring cut. When advancing the saw, be sure maintain a straight line by cutting along the high point of the cable; this affects the cut depth also. See following:

Proper Saw Position

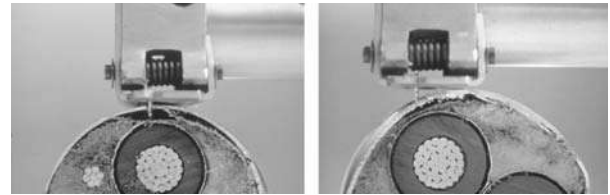

Correct

Incorrect

If it is necessary to stop cutting or if a portion of the cut is to be repeated, use caution when reinserting the blade as kickback may occur.

8. At the completion of the longitudinal cut, starting at the free end, insert a wide blade screwdriver into the cut and twist. Repeat until the ring cut is reached. This will cause the remaining metal in the valleys to break open and the armor to loosen on the cable. Do not drive the screwdriver into the cut with excessive force as this may damage the underlying conductors.
9. Slide the armor off the cable. In the event that the armor is tight around the cable, pliers may be used to grab the armor at the split and pull it away from the cable. For large diameter cables, where long lengths of armor are to be removed, two cuts spaced 180° apart are recommended so that the armor may be removed in two pieces.
 - For C-L-X Diameters 1 5/8" and Smaller Follow Steps 10. Through 13.
10. Using a hacksaw blade or tubing cutter, circumferentially score the C-L-X armor. Grip the cable in both hands with the score centered between hands, and flex the cable at the score line until it opens. Slide the sheath off the cable.
11. For C-L-X cables with an inner jacket or cable constructions where the C-L-X armor is tight fitting around the insulated conductors, the C-L-X saw should be used with the optional red colored cable guide. This guide assists in centering the saw on small diameter cable. The procedures and precautions of steps 3 to 9 apply here also.
12. Remove the cable fillers and marker tape and install the C-L-X fitting as per the manufacturer's instructions. The cable is now ready to be terminated into the enclosure.

CONDUCTOR COLOR CODING SEQUENCE

ICEA S-73-532 TABLE E-2
Color Sequence (No Green or White Conductors)

Conductor Number	Base Color	Tracer Color
1	Black	—
2	Red	—
3	Blue	—
4	Orange	—
5	Yellow	—
6	Brown	—
7	Red	Black
8	Blue	Black
9	Orange	Black
10	Yellow	Black
11	Brown	Black
12	Black	Red
13	Blue	Red
14	Orange	Red
15	Yellow	Red
16	Brown	Red
17	Black	Blue
18	Red	Blue
19	Orange	Blue
20	Yellow	Blue
21	Brown	Blue
22	Black	Orange
23	Red	Orange
24	Blue	Orange
25	Yellow	Orange
26	Brown	Orange
27	Black	Yellow
28	Red	Yellow
29	Blue	Yellow
30	Orange	Yellow
31	Brown	Yellow
32	Black	Brown
33	Red	Brown
34	Blue	Brown
35	Orange	Brown
36	Yellow	Brown
37	Black	

Special Order: Any or all of the following conductors may be added when specifically requested by the customer to meet his specific application requirements. These conductor codings comply with UL and NEC requirements

Purpose	Base Color	Tracer Color
Equipment Grounding	Uninsulated	
	Green	
Grounded	Green	1 or more continuous yellow stripes
	White	
	White	Black continuous stripe
	White	Red continuous stripe
	White	Blue continuous stripe
	White	Orange continuous stripe
	White	Brown continuous stripe
White	Numeric Printing	

CONDUCTOR COLOR CODING SEQUENCE

ICEA S-73-532 TABLE E-1
Color Sequence (INCLUDES GREEN AND WHITE CONDUCTORS)

Conductor Number	Base Color	Tracer Color
1	Black	—
2	White	—
3	Red	—
4	Green	—
5	Orange	—
6	Blue	—
7	White	Black
8	Red	Black
9	Green	Black
10	Orange	Black
11	Blue	Black
12	Black	White
13	Red	White
14	Green	White
15	Blue	White
16	Black	Red
17	White	Red
18	Orange	Red
19	Blue	Red
20	Red	Green
21	Orange	Green

CONDUCTOR IDENTIFICATION INFORMATION

E-1 Color sequences for utility conductor identification, see Appendix E, Table E-1, ICEA Standard S-73-532, includes green and white.

E-2 Color sequence for industrial conductor identification, see Appendix E, Table E-2, ICEA Standard S-73-532, excludes green and white.

METHOD-1 Conductor identification, colored compounds with tracers in accordance with the ICEA standard.

METHOD-2 Conductor identification, neutral compounds with tracers in accordance with the ICEA Standard.

METHOD-3 Conductor identification, neutral or single colored compounds with surface printing of numbers and color designations in accordance with the ICEA Standard.

METHOD-4 Conductor identification, neutral or single colored compounds with surface printing of numbers in accordance with the ICEA Standard.

METHOD-5 Conductor identification, individual color coding with braids in accordance with the ICEA Standard.

MISCELLANEOUS INFORMATION

Decimal equivalents of one inch

8ths	16ths	32nds	64ths	Decimal
—	—	—	1	.015625
—	—	1	2	.03125
—	—	—	3	.046875
—	1	2	4	.0625
—	—	—	5	.078125
—	—	3	6	.09375
—	—	—	7	.109375
1	2	4	8	.125
—	—	—	9	.140625
—	—	5	10	.15625
—	—	—	11	.171875
—	3	6	12	.1875
—	—	—	13	.203125
—	—	7	14	.21875
—	—	—	15	.234375
2	4	8	16	.25
—	—	—	17	.265625
—	—	9	18	.28125
—	—	—	19	.296875
—	5	10	20	.3125

Useful Identities, Equations and Conversion Factors

1 mil = 0.001"

1 circular mil = (1 mil)²

Area of a circle = Πr^2 or $\Pi D^2/4$

where,

$\Pi = 3.1416$

r = radius

D = diameter

1 mm = 39.4 mils

1 mile = 5280 ft

1 km = 0.6214 miles

1 km = 3281 ft

1 mile = 1.609 km

1 inch = 25.4 mm

1 meter = 3.281 ft

1 meter = 39.37 inches

1 ton (US) = 2000 lbs

To Convert	Multiply by	To Obtain
mils	0.0254	millimeters
circular mils	5.07×10^{-4}	square millimeters
inches	1.0×10^3	mils
inches	25.4	millimeters
feet	3.048×10^{-4}	kilometers
miles	1.609	kilometers
kilometers	0.6214	miles
kilometers	3.281×10^3	feet
pounds	0.4536	kilograms
pounds	4.448	Newtons (joules/meter)
pounds/ft	1.488	kilograms/meter
tons (US)	0.9078	tons (metric)
psi	0.00689	megapascals (Mpa)
volts/mil	0.03937	kV/mm
ohms/1000 ft	3.28	ohms/km
gigaohms - 1000 ft	305	gigaohms-meter

Temperature conversion table

TO CONVERT DEGREES		
To C	F or C	To F
-65.	-85	-121
-62.22	-80	-112
-59.45	-75	-103
-56.67	-70	-94
-53.89	-65	-85
-51.11	-60	-76
-48.34	-55	-67
-45.56	-50	-58
-42.78	-45	-49
-40.	-40	-40
-37.22	-35	-31
-34.44	-30	-22
-31.67	-25	-13
-28.89	-20	-4
-26.11	-15	5
-23.33	-10	14
-20.56	-5	23
-17.78	0	32
-15.	5	41
-12.22	10	50
-9.44	15	59
-6.67	20	68
-3.89	25	77
-1.11	30	86
1.67	35	95
4.44	40	104
7.22	45	113
10.	50	122
12.78	55	131
15.56	60	140
18.33	65	149
21.11	70	158
23.89	75	167
26.67	80	176
29.44	85	185
32.22	90	194
35.	95	203
37.78	100	212
40.56	105	221
43.33	110	230
46.11	115	239
48.89	120	248
51.67	125	257
54.44	130	266
57.22	135	275
60.	140	284
62.78	145	293
65.56	150	302
68.33	155	311
71.11	160	320
73.89	165	329
76.67	170	338
79.44	175	347
82.22	180	356
85.	185	365
87.78	190	374
90.56	195	383
93.33	200	392
96.11	205	401
98.89	210	410
101.67	215	419
104.44	220	428
107.22	225	437
110.	230	446
112.78	235	455
115.56	240	464
118.33	245	473
121.11	250	482
123.89	255	491
126.67	260	500
129.44	265	509
132.22	270	518
135.	275	527

NOTES

NOTES

District Offices, Manufacturing Plants & Service Centers

Manufacturing Plants



Orangeburg, SC - Compound Facility



Orangeburg, SC - Manufacturing Plant



Richmond, KY - Manufacturing Plant



Santa Maria, CA - Manufacturing Plant



Cumberland, RI - Manufacturing Plant



Paterson, NJ - Manufacturing Plant

Service Centers



Houston, TX



Kansas City, KS



New Orleans, LA



Portland, OR



Pittsburgh, PA

Corporate HDQ



Ramsey, NJ

Atlanta District Office
 (770) 928-9778
 FAX: (770) 928-0913
 E-Mail: atlanta@okonite.com

Baton Rouge District Office
 (504) 467-1920
 FAX: (504) 305-4773
 E-Mail: batonrouge@okonite.com

Birmingham District Office
 (205) 655-0390
 FAX: (205) 655-0393
 E-Mail: birmingham@okonite.com

Boston District Office
 (603) 625-1900
 (781) 749-3374
 FAX: (603) 624-2252
 E-Mail: boston@okonite.com

Buffalo District Office
 (603) 625-1900
 (603) 749-3374
 FAX: (603) 624-2252
 E-Mail: buffalo@okonite.com

Charlotte District Office
 (704) 542-1572
 FAX: (704) 541-6183
 E-Mail: charlotte@okonite.com

Chicago District Office
 (630) 961-3100
 FAX: (630) 961-3273
 E-Mail: chicago@okonite.com

Cleveland District Office
 (330) 926-9181
 FAX: (330) 926-9183
 E-Mail: cleveland@okonite.com

Dallas District Office
 (940) 383-1967
 FAX: (469) 630-0048
 E-Mail: dallas@okonite.com

Denver District Office
 (303) 772-3517
 FAX: (303) 772-3513
 E-Mail: denver@okonite.com

Houston District Office & Service Center
 (281) 821-5500
 FAX: (281) 821-7855
 E-Mail: houston@okonite.com

Kansas City District Office & Service Center
 (913) 422-6958
 FAX: (913) 422-1647
 E-Mail: kansascity@okonite.com

Los Angeles District Office
 (562) 590-3070
 Fax: (562) 590-3139
 E-Mail: losangeles@okonite.com

Minneapolis District Office
 (763) 432-3818
 FAX: (763) 432-3811
 E-Mail: minneapolis@okonite.com

New Orleans District Office and Service Center
 (504) 467-1920
 FAX: (504) 467-1926
 E-Mail: neworleans@okonite.com

New York District Office
 NJ (973) 742-8040
 NY (212) 239-0660
 FAX: (973) 742-2156
 E-Mail: newyork@okonite.com

Philadelphia District Office
 (302) 318-2054
 FAX: (302) 368-4163
 E-Mail: philadelphia@okonite.com

Phoenix District Office
 (480) 838-8596
 FAX: (480) 897-8924
 E-Mail: phoenix@okonite.com

Pittsburgh Service Center
 (724) 899-4300
 FAX: (724) 899-4320
 E-Mail: pittsburgh@okonite.com

Portland District Office & Service Center
 (503) 598-0598
 FAX: (503) 620-7447
 E-Mail: portland@okonite.com

Richmond District Office
 (302) 318-2054
 FAX: (302) 368-4163
 E-Mail: richmond-district@okonite.com

Salt Lake District Office
 (801) 262-1993
 FAX: (801) 262-3167
 E-Mail: saltlake@okonite.com

San Francisco District Office
 (925) 830-0801
 FAX: (925) 830-0954
 E-Mail: sanfrancisco@okonite.com

St Louis District Office
 (314) 770-9070
 FAX: (314) 770-9140
 E-Mail: stlouis@okonite.com

Tampa District Office
 (813) 627-9400
 FAX: (813) 246-4705
 E-Mail: tampa@okonite.com

International Sales
 (281) 821-5500
 FAX: (281) 821-7855
 E-Mail: houston@okonite.com